





James T. ...



**The Edinburgh Medical Series**

*General Editor.*—JOHN D. COMRIE

M.A., B.Sc., M.D., F.R.C.P.E.

**RADIOGRAPHY, X-RAY THERAPEUTICS  
AND RADIUM THERAPY**

***Volumes already published in this Series***

**TEXT-BOOK OF MIDWIFERY.** For Students and Practitioners. By R. W. JOHNSTONE, M.A., F.R.C.S., M.R.C.P.E. Crown 8vo, cloth, with 246 illustrations (3 coloured). **Price \$3.25**

**DISEASES AND INJURIES OF THE EYE.** A Text-book for Students and Practitioners. By WM. GEORGE SYM, M.D., F.R.C.S.E. Containing 25 full-page Illustrations, 16 of them in colour, and 88 figures in the text; also a type test card at end of volume. Small crown 8vo, cloth. **Price \$2.50**

**PRACTICAL PATHOLOGY INCLUDING MOR-BID ANATOMY & POST-MORTEM TECHNIQUE.** By JAMES MILLER, M.D., F.R.C.P.E. Crown 8vo, cloth, with 112 Illustrations, the Frontispiece being in colour. **Price \$2.50**

**MEDICAL APPLIED ANATOMY.** For Students and Practitioners. By T. B. JOHNSTON, M.B. Crown 8vo, cloth, containing 146 Illustrations in the Text and 3 full-page Illustrations in colour. **Price \$2.50**

**TUBERCULOSIS OF THE BONES AND JOINTS IN CHILDREN.** By JOHN FRASER, M.D., F.R.C.S. (Edin.), Ch.M. Royal 8vo, cloth, containing 51 full-page Plates, 2 of them in colour, and 164 other Illustrations in the Text. **Price \$4.50**

**The Macmillan Company**

**New York**



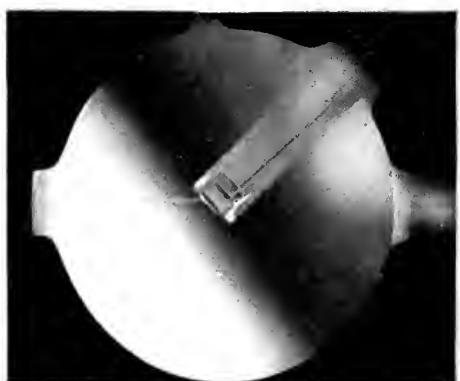
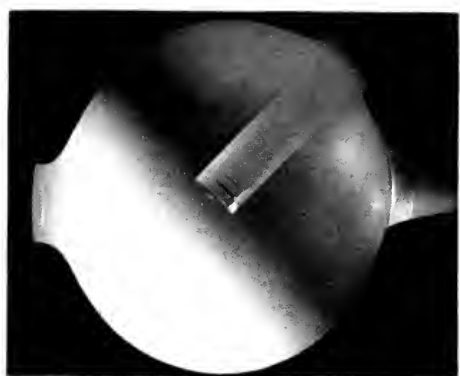
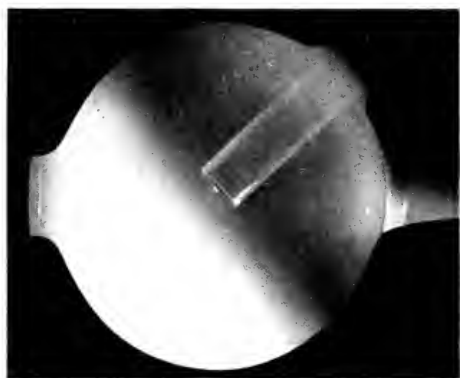



1. HARD CONDITION.

Note absence of blue gas in region of anode, also sharply-cut upper limit of green hemisphere. The condition indicates absence of reverse current.

2. NORMAL CONDITION.

Note faint blue cloud in region of anode. Reverse current is practically absent.

3. SOFT CONDITION.

Faint blue cloud has increased and is now very noticeable. The green hemisphere is still sharply cut, but a distinct cathode stream appears between the cathode and anti-cathode.

4. VERY SOFT CONDITION.

The faint blue cloud has spread further than in the preceding figure, and the cathode stream is more evident.

5. REVERSE CURRENT IN CIRCUIT.

The appearance of the tube is changed entirely. The hemisphere has lost its sharply-cut appearance and is irregular. The faint blue cloud, due to gas in the region of the anode, has also changed, and the upper hemisphere of the tube is occupied by irregular rings.

6. POLARITY REVERSED.

The cathode has become the anode and *vice versa*. Note the stream of gas at the back of the tube and the bright spot on glass wall opposite to the anti-cathode; also the absence of green hemisphere.

APPEARANCES OF X-RAY TUBE IN ACTION.

(Reproduced from coloured drawings kindly lent by Mr. C. Andrews.)



RADIOGRAPHY  
X-RAY THERAPEUTICS  
AND  
RADIUM THERAPY

BY

ROBERT KNOX

M.D. (EDIN.), M.R.C.S. (ENG.), L.R.C.P. (LOND.)

HON. RADIOGRAPHER, KING'S COLLEGE HOSPITAL, LONDON

DIRECTOR, ELECTRICAL AND RADIOTHERAPEUTIC DEPARTMENT, CANCER HOSPITAL, LONDON

HON. RADIOGRAPHER, GREAT NORTHERN CENTRAL HOSPITAL, LONDON

CAPTAIN R.A.M.C. (T.) 4TH LONDON GENERAL HOSPITAL (IN CHARGE OF X-RAY DEPARTMENT)

WITH SIXTY-FOUR PLATES  
TWO HUNDRED AND FORTY-SIX ILLUSTRATIONS IN THE TEXT  
AND A FRONTISPIECE IN COLOUR

New York

THE MACMILLAN COMPANY

1916

*All rights reserved*



TO

ALEXANDER MORISON

M.D. (EDIN.), F.R.C.P. (LOND. AND EDIN.)

IN RECOGNITION OF THE VALUABLE HELP AND KINDLY  
ENCOURAGEMENT FREELY RENDERED THROUGH MANY  
YEARS OF CLOSE ASSOCIATION



## PREFACE

THE object of this work is to present to the student and practitioner in as concise and practical a form as possible the essential points in radiography, X-ray therapeutics, and radium therapy. The chief aim throughout has been to present these leading features in such a form that the beginner may easily acquire a working knowledge of radiography, radiation technique, and therapy. The book is therefore a practical one, theoretical considerations having been omitted as far as possible.

The section on radiography has been illustrated as fully as possible, care having been taken to select only illustrations which have a definite educational value. Much attention has been paid to important points in the practical working of apparatus, and it is hoped that the student will be carried from the technical details to a consideration of results obtained, and their bearing on the diagnosis of diseases. For this purpose a number of anatomical and pathological diagrams have been incorporated in the text, and I would like gratefully to acknowledge the valuable data gathered from well-known works on anatomy, pathology, medicine, and surgery. The following books have been freely used in the compilation of the text : Gray's *Anatomy*, Heath's *Anatomy*, Cunningham's *Anatomy*, Holden's *Osteology*, Rose and Carless's *Surgery*, Erichsen's *Surgery*, Allbutt's *System of Medicine*, Osler's *Practice of Medicine*, and many others.

I also wish to acknowledge the valuable help obtained from a number of electrical firms, and personally to thank Mr. Howard Head for reading and correcting the section on instrumentation, and for compiling a glossary of terms used in medical electricity. My thanks are also due to Mr. Schall for permission to print passages from his admirable descriptions of methods of measurement of X-rays, to Mr. Geoffrey Pearce for preparing several drawings of apparatus, and to Mr. Andrews for many valuable suggestions regarding the X-ray tube and its manipulation.

I am also indebted to Mr. Thurstan Holland for several valuable prints, and for many hints on radiographic technique. Dr. R. W. A. Salmond has contributed several interesting prints, and has rendered some assistance in

the preparation of parts of the text. My thanks are also due to Mr. E. H. Shaw, pathologist to the Great Northern Central Hospital, for help in the descriptions of sections from tumours treated by radiations. Mr. A. H. Booker has been responsible for the preparation of the greater part of the prints from which the illustrations have been taken and also for the excellent micro-photographic work.

For the section on Radium Therapy Mr. C. E. S. Phillips, F.R.S.E., has been good enough to write a special article on the Physics of Radium.

I must also thank most heartily the General Editor, Dr. John D. Comrie, for in the first instance suggesting the book and then for indicating the combination of the allied subjects to be included in it; also for many valuable suggestions during the preparation and progress of the book. The idea of producing the plate illustrations in negative and positive is entirely his, and adds greatly to their value.

I am also greatly indebted to my old friend Alexander Mackay, B.A., for valuable help in arranging the text and correcting the proofs.

The index has been prepared by Mr. H. A. Low, and I gratefully acknowledge the invaluable assistance that he has given me at all times; I wish also to express my appreciation of his unfailing courtesy during many hours of close association.

Thanks are also due to my colleagues at the Cancer Hospital, King's College Hospital, and the Great Northern Central Hospital, for their help, always most readily given, on the many difficult points in diagnosis which are constantly encountered, and for the great help they have given in following up cases in which a radiographic diagnosis has been confirmed or otherwise in the operating room. The value of such confirmation or negation is very great, as it enables the radiographer to verify his observations on debatable and doubtful points, and renders the help he is able to give the physician or surgeon of much greater value. The importance of this co-operation is referred to in the text, and I consider it indispensable if the full value of the methods described in this book is to be obtained.

It is impossible to thank adequately all those who have assisted me in the production of the numerous plates which make up the list of illustrations, but I would like to tender my cordial thanks to the members of the Assistant and Nursing Staffs of the Great Northern Central Hospital, the Cancer Hospital, and King's College Hospital, all of whom have contributed to the whole, and without whose loyal and keen interest and help this work could not have been produced.

ROBERT KNOX.



# CONTENTS

## PART I.—RADIOGRAPHY

	PAGE
SOURCES OF ELECTRIC ENERGY . . . . .	3-27
Continuous current supply—Alternating current supply—Apparatus for heavy discharges—Apparatus for the production of single-impulse radiographs—Accumulators—Dynamos—Motor transformers—The induction coil—The control apparatus—The interrupter—Summary.	
X-RAY TUBES AND THEIR ACCESSORIES . . . . .	28-61
The focus tube—Suppression of reverse (inverse) current—Instruments for estimating the hardness of the X-ray tube.	
TUBE STANDS, COUCHES, COMPRESSORS, AND SCREENING STANDS . . . . .	62-79
The X-ray tube-stand—Couches and stands.	
THE ARRANGEMENT OF APPARATUS . . . . .	80-90
A small installation—Installation for a general hospital or consulting radiologist—Installation for a special hospital—Installation for a base hospital for military service.	
PRODUCTION OF THE RADIOGRAPH . . . . .	91-104
The plate or film employed—Exposure—The placing of photographic plates—The use of the intensifying screen—Development—Fixing—Washing and drying—Reduction—Intensification—Printing—Further points in exposure and development—Instructions for glazing gelatino-chloride prints.	
STEREOSCOPIC RADIOGRAPHY . . . . .	105-106
THE LOCALISATION OF FOREIGN BODIES . . . . .	107-122
Localisation of foreign bodies in special localities.	
RADIOGRAPHY OF THE NORMAL BONES AND JOINTS . . . . .	123-137
The skull and accessory sinuses—The cervical region—The bones of the chest—The dorsal spine—The lumbar spine—The pelvis—The upper extremity—The lower extremity.	
THE DEVELOPMENT OF THE BONES . . . . .	138-153
Radiographic survey of the joints showing epiphyses.	

INJURIES OF BONES AND JOINTS . . . . .	154-166
Injuries of the skull and spine—Fracture of the ribs—Fracture of the clavicle—Fracture of the scapula—Fractures of the humerus—Injuries in the region of the elbow-joint—Fracture of the shaft of the radius and ulna—Injuries at the wrist-joint—Fractures of the bones of the hand—Fractures of the pelvis—Injuries near the hip-joint—Fractures of the femur—Fractures of the patella—Fractures of the bones of the leg—Fractures in the neighbourhood of the ankle-joint.	
DISEASES OF BONE . . . . .	167-173
Classification of inflammatory affections of bone.	
DISEASES OF JOINTS . . . . .	174-178
Tuberculous disease of joints—Chronic articular rheumatism—Chronic articular gout—Loose bodies in joints—Rheumatoid arthritis or rheumatic gout—Hypertrophic arthritis or osteoarthritis—Charcot's joints.	
DIFFERENTIAL X-RAY DIAGNOSIS IN DISEASES OF BONES AND JOINTS . . . . .	179-187
Tumours of bone—Appearance of joints in tuberculosis—Tubercular dactylitis—Syphilitic dactylitis—Syphilis of bone—Chronic infective osteomyelitis—Acute osteomyelitis—Acute infective periostitis—Tumours of bone—Carcinoma of bone—Differential diagnosis of tumours of bone.	
THE X-RAY EXAMINATION OF THE THORAX AND ITS CONTENTS . . . . .	188-208
Radioscopy—Radiography—Diseases of the thorax—Differential diagnosis in diseases of the lungs—The examination of the heart and aorta.	
THE X-RAY EXAMINATION OF THE ALIMENTARY SYSTEM . . . . .	209-234
The examination of the cesophagus—Examination of the stomach—Examination of the small intestine—Examination of the large intestine—Foreign bodies in the alimentary canal.	
THE X-RAY EXAMINATION OF THE URINARY TRACT . . . . .	235-247
Technique—Anatomical relations of the urinary organs—Diseases of urinary tract including calculi—Technique of the examination of the urinary system with collargol solution.	
CONGENITAL MALFORMATIONS . . . . .	248

## PART II.—RADIATION THERAPEUTICS

INTRODUCTORY . . . . .	251-264
Action of radiation upon tissues—Action of radiations on normal tissues and morbid growths—Dangers attendant on the use of X-rays and radium.	

### A. X-RAY THERAPEUTICS

SPECIAL POINTS IN INSTRUMENTATION . . . . .	265-297
Methods of protection—Arrangement of apparatus—Methods used in estimation of dosage—Arrangements for exposure—Development—The use of filters—The choice of the X-ray therapeutic tube.	

# CONTENTS

	xi
	PAGE
THE TREATMENT OF DISEASES OF THE SKIN . . . . .	298
THE TREATMENT OF ENLARGED LYMPHATIC GLANDS . . . . .	307
THE TREATMENT OF RODENT ULCERS . . . . .	309
THE TREATMENT OF SARCOMATA . . . . .	312
THE TREATMENT OF CARCINOMATA . . . . .	312
THE TREATMENT OF ENLARGEMENT OF THE PROSTATE GLAND . . . . .	316
THE TREATMENT OF EXOPHTHALMIC GOITRE . . . . .	317
THE TREATMENT OF UTERINE FIBROMATA . . . . .	318
THE TREATMENT OF DISEASES OF THE BLOOD . . . . .	323
THE TREATMENT OF DISEASES OF THE LUNGS AND MEDIASTINUM . . . . .	327

## B. RADIUM THERAPY

PHYSICS OF RADIUM. By C. E. S. PHILLIPS, F.R.S.E. . . . .	329-344
Ionisation and recombination—Radium emanation—Measurement— Physiological action.	
THE PRACTICAL APPLICATION OF RADIUM TO DISEASE . . . . .	345-353
Methods of using radium—Filtration of radium rays—Radium tubes in the substance of a tumour—Treatment of deep-seated tumours by external applications.	
DOSAGE IN RADIUM THERAPY . . . . .	353
Relation between the value of radium and its activity.	
RADIUM IN GENERAL DISEASES . . . . .	357
RADIUM IN DISEASES OF THE EYE . . . . .	359
RADIUM IN DISEASES OF THE EAR, NOSE, AND THROAT . . . . .	359
RADIUM IN THE TREATMENT OF EXOPHTHALMIC GOITRE . . . . .	360
RADIUM IN THE TREATMENT OF MALIGNANT DISEASE OF THE THYROID GLAND	360
RADIUM IN THE TREATMENT OF DISEASES OF THE SKIN . . . . .	361
RADIUM IN GYNÆCOLOGICAL PRACTICE . . . . .	365
RADIUM IN SUPERFICIAL EPITHELIOMA AND RODENT ULCER . . . . .	368
RADIUM IN INFILTRATING EPITHELIOMA . . . . .	370
RADIUM IN SARCOMATA AND CARCINOMATA . . . . .	371
RADIUM IN CANCER OF THE TONGUE AND MOUTH . . . . .	373
RADIUM IN CANCER OF THE ŒSOPHAGUS . . . . .	374
RADIUM IN CANCER OF THE RECTUM, THE PROSTATE GLAND, AND THE BLADDER	375

## C. RADIUM AND X-RAYS

THE COMBINED USE IN MALIGNANT DISEASE . . . . .	378
GLOSSARY . . . . .	387
INDEX . . . . .	391



# LIST OF ILLUSTRATIONS

## FULL-PAGE PLATES

All the radiographic illustrations in the plates have been reproduced in negative and positive form, the object being to present the reader with what is actually seen when a negative and positive are examined. When comparing the two side by side it will be seen that the one is complementary to the other. For convenience of comparison the negative and positive have been reproduced from the same aspect; in actual practice the one is the reverse of the other.

Appearances of X-Ray Tube in Action ( <i>in colour</i> ) . . . . .	<i>Frontispiece</i>
	FACING PAGE
I. Normal Skulls . . . . .	124
II. Normal Skulls . . . . .	126
III. Skulls showing Departures from the Normal . . . . .	128
IV. Lower Jaw and Cervical Region . . . . .	129
V. Normal Lumbar Spine and Pelvis . . . . .	133
VI. Normal Shoulder-joint . . . . .	135
VII. Normal Elbow and Fractures in Region of Elbow-joint . . . . .	138
VIII. Normal Knee-joint . . . . .	140
IX. Showing Epiphyses of Hip, Knee, and Ankle-joints . . . . .	147
X. Fractures in Region of Shoulder-joint . . . . .	156
XI. Fractures in Region of Shoulder-joint . . . . .	158
XII. Fractures in Region of Elbow-joint . . . . .	161
XIII. Fractures in Forearm, Wrist, and Hand . . . . .	162
XIV. Fractures at Wrist-joint . . . . .	163
XV. Fractures of Wrist and Hand . . . . .	164
XVI. Normal Hip, Dislocation, and Fracture at Hip-joint . . . . .	166
XVII. Injuries and Disease of Pelvis and Hip-joint . . . . .	167
XVIII. Injuries at Knee-joint . . . . .	168
XIX. Fractures of Bones of Leg . . . . .	169
XX. Fractures at the Ankle-joint . . . . .	168 & 169
XXI. Fractures of Leg, Ankle, and Foot . . . . .	168 & 169
XXII. Chronic Inflammatory Conditions of Bones . . . . .	170
XXIII. Inflammatory and other Affections of Bones . . . . .	171

	FACING PAGE
XXIV. Tubercular Disease of the Hip-joint . . . . .	173
XXV. Tubercular Disease of other Joints . . . . .	174
XXVI. Tuberculosis of Bones and Joints . . . . .	175
XXVII. Chronic Arthritic Changes at the Knee-joint . . . . .	176
XXVIII. Diseases and Curvature of the Spine . . . . .	179
XXIX. Tuberculosis of Bones and Joints . . . . .	181
XXX. Tumours of Bone . . . . .	183
XXXI. Tumours of Bone . . . . .	186
XXXII. Malignant Diseases of the Chest . . . . .	188
XXXIII. Chest showing Pleural Effusion and its Absorption . . . . .	190
XXXIV. Chests showing Pulmonary Tuberculosis . . . . .	194
XXXV. Chests showing Pulmonary Tuberculosis . . . . .	197
XXXVI. Chests showing Secondary Carcinoma . . . . .	199
XXXVII. Chests showing Changes in Heart and Lungs . . . . .	201
XXXVIII. Chest showing Chronic Pleurisy with Bi-lateral Effusion . . . . .	202
XXXIX. Chests . . . . .	204
XL. Chests showing Aneurism and New Growth . . . . .	207
XLI. Chest showing Dilatation of Oesophagus . . . . .	211
XLII. Stomach showing Pyloric Stenosis . . . . .	213
XLIII. Stomach and Colon showing Visceroptosis . . . . .	218
XLIV. Stomach and Colon showing Visceroptosis . . . . .	220
XLV. Opaque Meal in Stomach and Colon . . . . .	222
XLVI. Hour-glass Contraction of the Stomach . . . . .	226
XLVII. Stomach showing Obstruction at Pylorus . . . . .	231
XLVIII. Opaque Enema in Colon . . . . .	234
XLIX. Urinary Calculi . . . . .	241
L. Tuberculosis of Kidney and Mesenteric Glands . . . . .	243
LI. Urinary Calculi and Gallstones . . . . .	244
LII. Kidneys, Ureter, and Bladder . . . . .	245
LIII. Dermoid Cyst in Pelvis . . . . .	246
LIV. Congenital Deformities . . . . .	248
LV. Changes produced in Normal Tissues by Radiations . . . . .	254
LVI. Changes observed in Tumours which have been treated by Radiations . . . . .	256
LVII. Changes observed in Tumours which have been treated by Radiations . . . . .	258
LVIII. Changes observed in Tumours which have been treated by Radiations . . . . .	260
LIX. Rodent Ulcers, treated with Radium, X-Rays, and CO <sub>2</sub> . . . . .	309
LX. Cases of Rodent Ulcers treated with Radium . . . . .	311
LXI. Carcinomata treated by X-Rays . . . . .	314
LXII. Stages in the treatment of an Atrophic Scirrhous Cancer of the Breast . . . . .	316
LXIII. Rodent Ulcers treated with Radium and X-Rays . . . . .	368
LXIV. Recurrent Carcinoma after Removal of Breast . . . . .	372

## ILLUSTRATIONS IN THE TEXT

FIG.	PAGE
1. Gaiffe Rochefort outfit for alternating current . . . . .	4
2. Alternating current high-tension rectifier . . . . .	5
3. Single-impulse outfit, showing switch, and switch-table with time relay . . . . .	7
4. Snook apparatus . . . . .	9
5. Diagram of Snook apparatus . . . . .	10
6. Accumulator connections . . . . .	11
7. Gas engine and dynamo . . . . .	11
8. Induction coil . . . . .	13
9. Plan of winding of coil, primary and secondary, with connection to condenser and break . . . . .	13
10. } Connections of the X-ray tube to the coil . . . . .	15
11. }	
12. Diagram to illustrate construction of a centrifugal mercury interrupter . . . . .	17
13. Plan of connections for Dreadnought interrupter . . . . .	18
14. Dreadnought interrupter . . . . .	19
15. Dreadnought interrupter showing detail . . . . .	19
16. Instanta interrupter . . . . .	20
17. Sanax interrupter . . . . .	20
18. Improved Mackenzie Davidson interrupter . . . . .	22
19. Single-point electrolytic interrupter . . . . .	23
20. Three-point electrolytic interrupter . . . . .	23
21. Single-point electrolytic interrupter . . . . .	23
22. Trolley control table, with resistances arranged to facilitate time and rapid exposures . . . . .	23
23. Larger view of top of trolley control table to show the regulating parts . . . . .	24
24. Gaiffe interrupter . . . . .	26
25. Diagram of an X-ray tube with parts named . . . . .	28
26. Radiator tube constructed for heavy discharges . . . . .	29
27. Cyclops radiator tube . . . . .	30
28. Water-cooled tube arranged for overhead work . . . . .	31
29. Water-cooled tube for overhead or under the couch work, showing mica and carbon regulator . . . . .	32
30. Dessauer tube with atomiser for cooling the anti-cathode . . . . .	34
31. Heavy anode tube. Osmosis regulator . . . . .	35
32. Coolidge X-ray tube . . . . .	36
33. Details of Coolidge tube . . . . .	36
34. Complete Coolidge X-ray equipment in position . . . . .	37
35. Diagram of connections for Coolidge tube . . . . .	37
36. } Connections of the X-ray tube to the coil . . . . .	40
37. }	

FIG.	PAGE
38. Connection of X-ray tube to the coil . . . . .	40
39. Manipulation of the X-ray tubes . . . . .	43
40. Mica regulator . . . . .	45
41. Bauer air-valve . . . . .	46
42. Gundelach regeneration . . . . .	47
43. Spark-gap . . . . .	48
44. Single valve tube . . . . .	50
45. Triple valve tube . . . . .	50
46. French valve tube . . . . .	51
47. Oliver Lodge valve tube . . . . .	51
48. Gundelach valve tube . . . . .	52
49. Oscilloscope tube . . . . .	53
50. Oscilloscope tube in action . . . . .	53
51. Diagram showing the paths taken by primary beams and secondary rays . . . . .	54
52. Diagram showing the use of a diaphragm between tube and plate . . . . .	55
53. Diagram showing the use of a cylinder diaphragm . . . . .	55
54. Adjustable spintermeter . . . . .	56
55. Bauer qualimeter . . . . .	56
56. Walter's radiometer . . . . .	59
57. Benoist radiometer . . . . .	59
58. Protected front for Fig. 57 . . . . .	59
59. Wehnelt's crypto-radiometer . . . . .	60
60. Milliamperemeter . . . . .	60
61. Pillar stand, protected tube-box, and accessories . . . . .	63
62. A form of tube-stand . . . . .	64
63. A convenient type of tube-stand with iris diaphragm . . . . .	64
64. Tube-box with extension tube . . . . .	65
65. Tube-box with rectangular diaphragm . . . . .	65
66. A convenient form of X-ray couch . . . . .	67
67. Albers-Schönberg compressor . . . . .	68
68. A couch fitted with protected tube-box underneath . . . . .	68
69. Extension tube of a kidney compressor to show method of compression . . . . .	69
70. Screening stand arranged for stereoscopic work in the upright position . . . . .	70
71. Screening stand arranged for work beneath the table . . . . .	71
72. Screening stand arranged for examinations in the upright position . . . . .	71
73. Screening stand arranged to work as a compressor . . . . .	72
74.   Wenekebach screening stand . . . . .	73
75.	
76. A useful form of universal examining chair . . . . .	74
77. Examining chair fitted with mechanical movements to facilitate the rapid manipulation of the patient . . . . .	79
78. A convenient form of apparatus arranged on an upright cabinet . . . . .	81
79. Diagram to illustrate the parts as arranged in Fig. 78 . . . . .	81



LIST OF ILLUSTRATIONS

xvii

FIG.	PAGE
80. Plan for consulting-room or hospital outfit . . . . .	83
81. Plan of the X-ray and electrical departments at King's College Hospital . . . . .	84
82. Plans of the electrical department at the Cancer Hospital, Fulham . . . . .	86
83. Portable X-ray installation arranged for radiography from beneath couch . . . . .	88
84. Portable X-ray installation packed ready for transit . . . . .	89
85. Slide rule . . . . .	93
86. Normal hand to illustrate value of an intensifying screen . . . . .	96
87. Radiogram to illustrate the latitude of exposure . . . . .	102
88. Radiogram to illustrate the latitude of exposure . . . . .	103
89. Wheatstone stereoscope . . . . .	108
90. Pirie stereoscope . . . . .	108
91. Diagram to show method of taking a lateral view . . . . .	110
92. Diagram showing Mackenzie Davidson method . . . . .	111
93. Mackenzie Davidson cross-thread localiser . . . . .	112
94. Diagram to illustrate simple formula for localising . . . . .	113
95. Diagram to illustrate Mackenzie Davidson's short method of localisation . . . . .	113
96. Graduated scale in Hampson localiser . . . . .	114
96 <i>a</i> . Hampson localiser, diagram to illustrate method . . . . .	114
97. Bullet in brain. Fragments in face . . . . .	119
98. Fracture of lower jaw ; foreign body in soft parts ; a portion of shrapnel above the jaw bone . . . . .	120
99. Fragment of shell in region of hip-joint . . . . .	120
100. Fracture of tibia, portions of shell in limb . . . . .	121
101. Fragments of bullet in limb . . . . .	121
102. Fragments of shrapnel in hand . . . . .	121
103. Arrangement of X-ray tube and fluorescent screen . . . . .	122
104. Sweet localiser . . . . .	124
105. Dr. M. Berry's chair for frontal sinuses, etc. . . . .	125
106. Position for radiography of the mastoid sinuses . . . . .	126
107. Chair for cranial radiography . . . . .	127
108. Chair for cranial radiography, with patient in position . . . . .	128
109. Upper cervical region, antero-posterior view . . . . .	130
110. Normal cervical and upper dorsal region showing the sterno-clavicular articulation . . . . .	131
111. Showing bones at ankle and foot with epiphyses, and dates at which they unite with the diaphyses . . . . .	144
112. Foot . . . . .	145
113. Diagram to show the epiphyses entering into the knee-joint . . . . .	145
114. Diagrams to illustrate the appearances of the epiphyses at the knee-joint, traced from radiographs . . . . .	146
115. Lateral view of knee-joint, showing epiphyses . . . . .	146
116. Antero-posterior view of knee-joint showing epiphyses . . . . .	147
117. Fracture of tibia and fibula . . . . .	147
118. Diagram to show the epiphyses and bones entering into the hip-joint . . . . .	147

FIG.	PAGE
119. Pelvis and femora of a child two days old, showing ossification of bones of pelvis, hip, and knee joints . . . . .	148
120. Diagram showing the bones forming the wrist-joint and joints of the finger	149
121. Hand of a child over five years old . . . . .	149
122. Shows stage of ossification in a young adult under twenty years . . . . .	150
123. Diagram showing epiphyses of the bones forming the elbow-joint . . . . .	150
124. Elbow-joint, antero-posterior view, shows epiphyses. Age 14 . . . . .	150
125. Lateral view of elbow-joint, to show epiphyses. Age 14 . . . . .	151
126. Diagram to show bones entering into the shoulder-joint . . . . .	151
127. Normal shoulder-joint showing condition of epiphyses at the head of humerus . . . . .	152
128. Shoulder-joint, showing epiphyseal line . . . . .	152
129. Comminuted fracture of angle of lower jaw . . . . .	155
130. Fracture through ramus of lower jaw . . . . .	155
131. Fracture dislocation of cervical vertebræ . . . . .	156
132. Fractures of vertebral border of scapula and three ribs (gunshot wound) . . . . .	157
133. Fracture of shaft of radius and upper end of ulna (gunshot wound) . . . . .	159
134. Fracture of lower end of humerus, with backward displacement of the lower fragment . . . . .	159
135. Fracture of shaft of humerus ; rotation of lower fragment and elbow-joint	160
136. Fracture through external condyle with forward and upward displacement of the fragment of bone . . . . .	160
137. Dislocation of elbow-joint . . . . .	161
138. Fractures through shafts of radius and ulna . . . . .	161
139. Fracture of shaft of ulna (the result of a gunshot wound) . . . . .	162
140. Fracture through shafts of both femora . . . . .	165
141. Fracture of os calcis (gunshot wound) . . . . .	166
142. Typhoid osteitis and periostitis resulting in an abscess . . . . .	170
143. Elbow-joint showing disease . . . . .	170
144. Wrist and hand of child, showing changes in lower end of radius and ulna due to rickets . . . . .	172
145. Tuberculosis of left hip-joint, particularly affecting the acetabulum . . . . .	175
146. Arthritis following injury of knee-joint. Lateral view . . . . .	176
147. Sarcoma of lower end of femur . . . . .	182
148. Chondro-sarcoma of lower end of tibia . . . . .	183
149. Sarcoma at upper end of humerus . . . . .	183
150. Tumour of clavicle . . . . .	184
151. Exostosis of lower end of femur . . . . .	185
152. Traumatic myositis ossificans . . . . .	186
153. Upright screening stand with automatic stereoscopic movements of tube and plate-holder controlled from the switch-board . . . . .	189
154. Thorax of an adult . . . . .	190
155. Normal lower cervical and upper dorsal vertebræ, showing the position for demonstration of cervical ribs and apices of the lungs . . . . .	191

# LIST OF ILLUSTRATIONS

xix

FIG.	PAGE
156. Position of thorax for lateral oblique position, to show position of plate and source of X-rays . . . . .	206
157. Diagram to illustrate the appearance of thorax in semi-lateral position . . . . .	206
158. Diagrams (after Holz knecht) to illustrate points of difference between dilated aorta and an aneurism . . . . .	207
159. Diagram to show the position for lateral oblique examination of the thorax . . . . .	210
160. Diagrammatic representation of the lateral view of thorax . . . . .	211
161. Appearances seen on fluorescent screen after patient has taken bismuth food shown diagrammatically . . . . .	211
162. Diagram to illustrate the appearance seen in a semi-lateral view of the thorax . . . . .	211
163. Diagram from a text-book of anatomy showing position of stomach . . . . .	212
164. The position of the empty stomach. Diagrammatic representation of the screen examination . . . . .	212
165. Diagrams showing stages of filling of stomach by opaque meal . . . . .	213
166. Diagrams to illustrate the stages of a bismuth meal . . . . .	217
167. Types of stomach . . . . .	220
168. Diagram to show position of stomach in ptosis . . . . .	223
169. Diagrammatic representation of pyloroptosis, with some atony of the stomach . . . . .	223
170. Diagram to represent a condition met with in examination of the stomach . . . . .	225
171. Hour-glass stomach . . . . .	226
172. Hour-glass contraction of the stomach . . . . .	226
173. Three examples of carcinoma of the stomach . . . . .	228
174. Illustrating the appearances seen in carcinoma at pyloric end of stomach . . . . .	228
175. Situations of tumour of stomach . . . . .	228
176. Opaque meal in ileum and caecum, five hours after ingestion . . . . .	230
177. Same case at a later stage, ten hours after ingestion . . . . .	231
178. Diagrammatic representation of colon filled with bismuth food . . . . .	232
179. Couch fitted with kidney compressor . . . . .	237
180. X-ray couch to illustrate method of compression . . . . .	237
181. Diagram to illustrate the "areas" to be examined in radiography of the urinary tract . . . . .	239
182. Kidney area, showing stone in left kidney . . . . .	241
183. Stone in ureter . . . . .	242
184. Large stone in the bladder . . . . .	243
185. X-ray treatment cubicle . . . . .	266
186. Milliamperemeter . . . . .	267
187. Bauer qualimeter . . . . .	268
188. Therapeutic outfit suitable for deep therapy . . . . .	269
189. Mereury interrupter with gas di-electric . . . . .	270
190. Mereury interrupter showing details . . . . .	270
191. Dipping interrupter with revolution counter . . . . .	271
192. Morton rectifier fitted to a coil outfit with control table . . . . .	272

FIG.	PAGE
193. Diagram of connections for Morton rectifier . . . . .	273
194. Triple valve tube . . . . .	273
195. Method of connecting coil to valve tube and X-ray tube. Valve tube on positive pole . . . . .	275
196. Method of connecting coil to tube. Valve tube on negative pole . . . . .	275
197. Tube stand for deep therapeutic work . . . . .	275
198. A convenient arrangement of apparatus for therapeutic work . . . . .	276
199. Apparatus arranged on an upright cabinet . . . . .	277
200. Diagram to show arrangement of apparatus on an upright cabinet . . . . .	277
201. Complete Kienböck quantimeter . . . . .	282
202. Arrangement of apparatus and paper when using Kienböck's method of estimating dosage . . . . .	283
203. Developing the strips . . . . .	284
204. Comparing the wet strip with the standard scale, using the slide . . . . .	285
205. Comparison of the dry strip without the slide . . . . .	285
206. Plain strips, exposed and developed . . . . .	286
207. Strips exposed with 1 mm. aluminium and developed . . . . .	286
208. Strips exposed with aluminium ladder and developed . . . . .	286
209. Chart of X-ray exposures, to show method used in recording dosage of Kienböck's method . . . . .	287
210. Lovibond's tintometer, adapted and standardised . . . . .	288
211. Curves showing colour developed by Sabouraud's pastille when exposed to unfiltered X-rays in measured doses . . . . .	290
212. Hampson radiometer . . . . .	291
213. Diagram to illustrate a method of circulating water to the anti-cathode of a tube . . . . .	294
214. Macalaster Wiggin X-ray tube . . . . .	295
215. Penetrans tube . . . . .	295
216. Dessauer therapeutic tube . . . . .	296
217. Diagram illustrating Dr. Adamson's method . . . . .	302
218. Diagram showing centres of areas to be rayed . . . . .	302
219. Chronic ulcer of hand of several years' duration showing improvement under X-ray treatment . . . . .	306
220. Special form of gold leaf electroscope . . . . .	332
221. Apparatus for pumping off and collecting radium emanation . . . . .	333
222. Combined pump and apparatus for concentration of radium emanation by liquid air . . . . .	333
223. Apparatus for charging glass or other applicators with radium emanation after sparking . . . . .	334
224. Curve showing decay of radium emanation with time . . . . .	335
225. Arrangement for the preparation of water impregnated with radium emanation . . . . .	338
226. Various forms of radium applicators . . . . .	340
227. Friction device for charging electroscopes . . . . .	342
228. Apparatus for inhalation of radium emanation and oxygen . . . . .	347

## LIST OF ILLUSTRATIONS

xxi

FIG.	PAGE
229. Glass applicators for employment of radium emanation . . . . .	348
230. Outer and inner tubes for salts of radium . . . . .	350
231. Flat metal applicator . . . . .	351
232. Showing method of arranging tubes with filters . . . . .	351
233. Silver screen to contain two tubes . . . . .	351
234. Radium in a flat metal tube showing, by dotted lines, area of active service.	351
235. Radium tube contained in rubber tubing . . . . .	351
236. Radiogene . . . . .	357
237. Application of radium to the eyelid . . . . .	359
238. Circular applicator suitable for the treatment of superficial skin lesions .	361
239. Applicator in box . . . . .	361
240. Uterine sound with radium tube at extremity . . . . .	366
241. Radium tube arranged for the treatment of the floor of the mouth . . .	373
242. Radium tube in an œsophageal tube, arranged for the treatment of an œsophageal growth . . . . .	374
243. Tube arranged on a length of pliable silver wire . . . . .	374
244. Shows radium tube <i>in situ</i> , for the treatment of carcinoma of the œsophagus, situated close to the cricoid cartilage . . . . .	375
245. Diagram to illustrate method of introducing radium tubes into lower bowel	376



## PART I.—RADIOGRAPHY





## SOURCES OF ELECTRIC ENERGY

### Continuous Current Supply

The most efficient and the most convenient form of electric supply is the continuous current, because it can be used without any alteration or modification for all types of interrupters. For mercury interrupters provision should be made for a current supply of up to 12, for electrolytic interrupters up to 20 amperes or more. These currents will suffice for an ordinary installation where very rapid exposures are not necessary. When wiring for an installation it is always advisable to have installed wires of larger capacity than the actually required amperage, for we may at a later date require a larger current for a more powerful outfit, which, to operate to its full output, may require up to 50 amperes. The tendency is to increase the current-consuming capacity of the apparatus—single-flash coils, Snook apparatus, and modern high-tension transformers requiring for an instantaneous exposure from 60 to 80 amperes.

When arranging for a current supply for one of these outfits it is well to provide for 100 ampere-circuit, in order that the operator need have no fear of either overloading his main cables or blowing his main fuses.

The main fuses of such installations should be in an accessible position, and it is well to have a supply of fuse wire near at hand, and when large fuse cartridges are used a spare one should always be kept ready for use. Much annoyance from delay may thus be avoided. It is of the greatest practical value to have, instead of the ordinary wall plug, a double-pole switch and two single-pole cut-outs enclosed in a lock-up case fitted on the wall of the radiographic room. In this way the switch and fuses are always accessible, and in addition it is possible by opening the switch to isolate all the apparatus from the supply mains.

### Alternating Current Supply

If the supply is an alternating current with a periodicity of 40 to 60, and the X-rays are not needed for very short exposures, it may be coupled directly to some types of mechanical interrupters. One of the most useful types of installation for alternating current is a Gaiffe Rochefort transformer with a Gaiffe gas mercury interrupter. Very good work may be done with

this apparatus, and the only difficulty occurs in the starting of the interrupter; the motor has to synchronise with the periodicity of the supply, and it requires a little practice to enable the operator to overcome this initial difficulty.

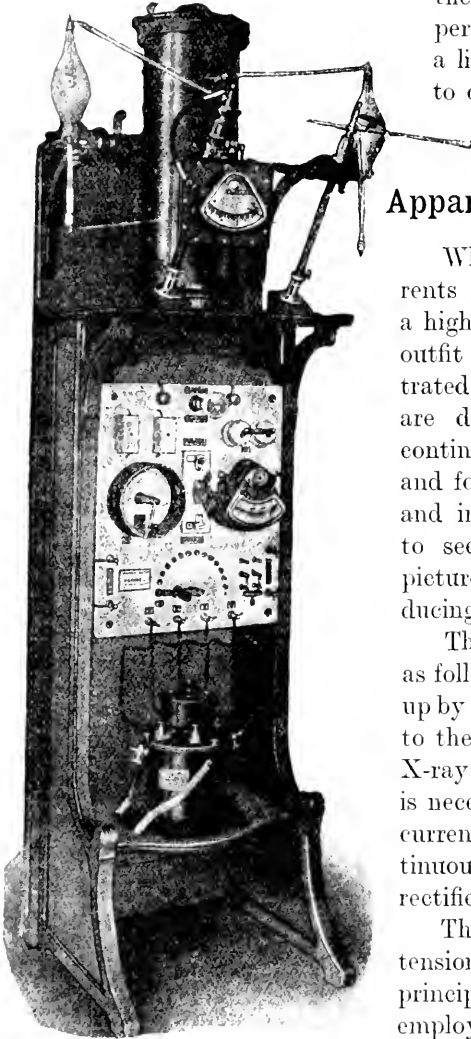

FIG. 1.—Gaiffe Rochefort outfit for alternating or continuous current. For alternating supply there is a difference in the arrangement of the interrupter. (Medical Supply Association.)

## Apparatus for Heavy Discharges

When it is necessary to use heavy currents for instantaneous radiography then a high-tension rectifier or a powerful coil outfit is necessary. Such a form is illustrated in Fig. 2. These high-tension rectifiers are designed for generating absolutely continuous current impulses for the tubes and for producing large outputs for rapid and instantaneous radiography, in order to secure good radiographs and screen pictures without at the same time producing any inverse radiation.

The principle of such an apparatus is as follows: Alternating current is stepped up by means of a high-tension transformer to the pressure necessary to stimulate an X-ray tube, but as continuous current is necessary, the high-tension alternating current is converted into a pulsating continuous current by means of a synchronous rectifier.

The chief factor is therefore a high-tension rectifier which is designed on the principle of the well-known commutator employed for dynamos and motors. This rectifier is coupled mechanically and electrically with the motor, alternating in such a manner that commutation takes place in synchronism with the frequency of the

alternating current. For instance, if alternating current is available having a frequency of 50 cycles per second, the rectifier will give, in the same time, one hundred continuous current impulses, or expressed scientifically, the rectifier is in synchronism with the alternating current.

The commutation of the rectifier always occurs at the moment when the alternating current is at zero value, that is, at the moment of the change of direction. When working accurately this arrangement practically prevents the generation of inverse current which is so harmful to the tubes.

Synchronism is obtained simply and absolutely by employing a rotary converter which is connected to a continuous supply, and which at the same time supplies the alternating current to the transformer and rotates the rectifier which is mounted on the same shaft.

**Alternating Current High-tension Rectifier.**—When using the alternating current, the current for the transformer is derived direct from the supply, the rectifier being driven by a self-starting single-phase synchronous motor which takes the place of the converter.

The outfits made for alternating current are smaller than for continuous, and these small outfits are without doubt the best to use where ordinary X-ray work only is required, that is not instantaneous, as there is no trouble from inverse radiation, no interrupter to synchronise, no rectifier to attend to, and no expensive rotary converter required.

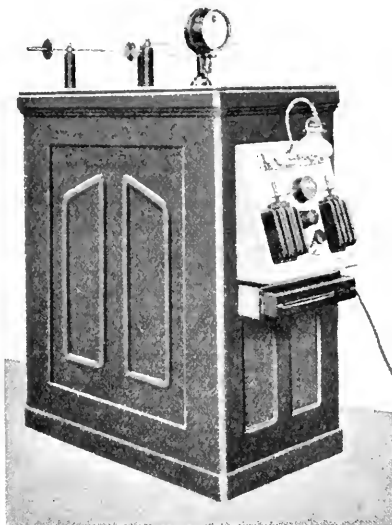

FIG. 2.—Alternating current high-tension rectifier. (Siemens.)

## Apparatus for the Production of Single-Impulse Radiographs

The rapid development of the finer methods of examination by means of X-rays has set the designers of electro-medical apparatus a number of new problems. It was necessary to increase the capacity of the X-ray apparatus in order to meet the demands of medical science, particularly of that branch devoted to the internal organs. It was necessary to evolve new apparatus, not only capable of meeting the requirements of the ordinary X-ray practice, such as therapeutic irradiation, the ordinary X-ray illumination, and the production of time and instantaneous exposures, but also sufficiently powerful to give sharp photographs of organs in motion, such as the stomach and heart.

While in the case of the stomach with its comparatively slow movements an exposure from  $\frac{1}{5}$  to  $\frac{1}{10}$  second is sufficient to give sharp pictures, in the case of the heart the exposure must only be about  $\frac{1}{100}$  second in order to produce a sufficiently sharp silhouette of the heart on the photographic plate. The lungs, and especially the glands and vessels at the hilus, also show up well in these instantaneous photographs, which have been termed "single-impulse photographs," so that the smallest infiltrations, which would not be easily seen with longer exposures on account of the action of the heart,

can easily be diagnosed by the observer. Further, the act of swallowing can be very well studied by the single-impulse method.

Attempts have frequently been made to solve the problem of taking X-ray photographs with exposures of about  $\frac{1}{1000}$  second, and the apparatus constructed for this purpose was chiefly based on a single sudden interruption of the primary current of the induction coil, so as to obtain a very powerful inductive current in the secondary, sufficient to produce a brilliant lighting up of the X-ray tube.

It is obvious that this single short-current impulse through the X-ray tube must be of great intensity. This implies induction coils of particularly powerful construction differing considerably in electrical and magnetic respects from the customary intense current induction coils used up to the present for the pseudo-instantaneous exposures. These induction coils are recognised externally by being provided with a heavy and substantial iron core.

In spite of the heavy currents in the primary circuit—currents closely approaching the maximum permissible in the usual supply mains—it was not found possible to secure radiographs of sufficient clearness in all cases, for instance in the stomach of stout people or distant exposures of the thorax. In such cases recourse had to be had to the customary methods of instantaneous radiography, *i.e.* the use of induction coils working with a mercury or Wehnelt interrupter. For this method of working, however, the single-impulse induction coil, which is very sluggish magnetically, is not very suitable, *i.e.* the times of exposure required when using interrupters were relatively longer than those required for the smaller intense-current induction coils, quite apart from the fact that the short-time exposures ( $\frac{1}{10}$  second to  $\frac{1}{5}$  second) which might be obtained with the high-voltage rectifier were not nearly approached. An improved apparatus has been constructed. This equipment is a combination of the well-known high-tension rectifier with a single-impulse apparatus. It enables radiographs of the heart to be taken with exposures of about  $\frac{1}{1000}$  second by the single-impulse method, and permits all other radiographs to be taken by means of the rectifier with exposures up to  $\frac{1}{10}$  second.

There are other advantages connected with the use of this form of apparatus, in addition to the considerably reduced exposures, which are impossible with the single-impulse induction coil outfit when working with interrupters.

It is of great advantage that the transformer which is used in the customary manner for working with the rectifier is also used for the photographs on the single-impulse method. As compared with induction coils with open magnetic circuit, the transformer with its closed iron core possesses a much higher efficiency. This is of particular advantage in connection with the single-impulse method, as the current taken from the power mains may be kept within the prescribed limits, a matter of considerable importance.

In this connection the further advantage may be pointed out that the equipment can be connected directly to 400-volt power circuits; this voltage

is now frequently adopted, but is unsuitable for induction coils, and a reduction in the voltage, which is in most cases not feasible, would be necessary for satisfactory operation.

A description of the single-impulse system is as follows: Using the apparatus as a rectifier the continuous current is converted into alternating

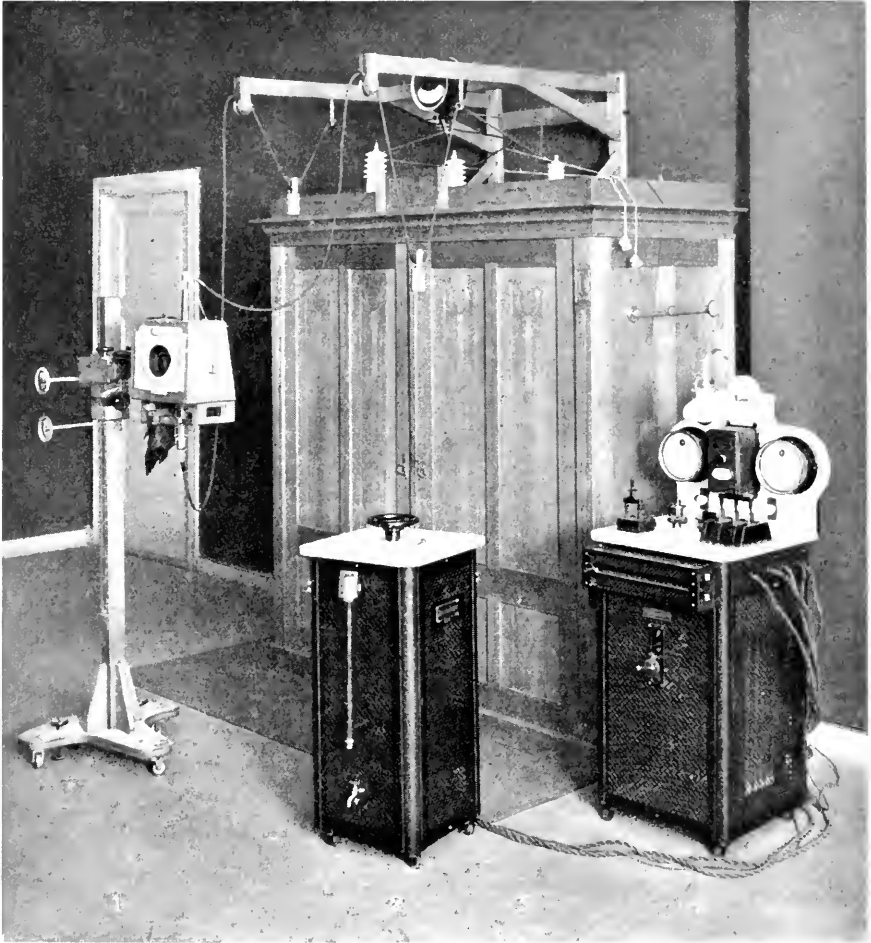

FIG. 3.—Single impulse outfit (Siemens), showing switch (2), and switch-table with time relay (4) for using outfit as a rotating high-tension rectifier. Cabinet (3) contains single-impulse transformer and rectifier, connected to an X-Ray tube (1).

current by means of a rotating converter, the alternating current being fed to a high-voltage transformer.

The alternating current from the transformer is led through the rectifier driven by the rotary converter, the high-tension alternating current being thus converted into high-tension continuous current. This high-voltage continuous current is measured by a milliamperemeter and then led through the X-ray tube.

The current in the tube is adjusted by resistances which are so pro-

portioned that the current may be adjusted from  $\frac{1}{4}$  milliampere to about 80 milliamperes.

For taking single-impulse photographs the rotary rectifier is no longer used, but only the high-voltage transformer built into the apparatus. For single-impulse operation the transformer is no longer excited by the alternating current from the converter, but obtains its current through the single-impulse switch from the continuous current mains.

The principle of the single-impulse method is briefly as follows: In the methods known hitherto, the current flowing through the primary winding of the induction coil is suddenly interrupted after reaching its maximum intensity, *i.e.* at the moment when the iron core of the induction coil has attained maximum saturation, and the result of the sudden disappearance of the flux is an inductive "kick" in the secondary winding. The force of this inductive "kick" is considerably greater in this method inasmuch as the flux in the iron core does not merely drop from its maximum to zero but from a positive to a negative maximum. In consequence, the induction in the secondary winding must be particularly strong, and the X-ray tube gives a flash of more than double the intensity that would be obtained with a simple interruption of the current. Measurements have shown that the time of exposure with this method is  $\frac{1}{100}$  second. This increase in effect is obtained by reversing the primary current. The whole of the switch operation is carried out by simple manipulation of a hand-wheel at the single-impulse switch-table. After taking a single-impulse photograph, the switch is immediately ready for use again, so that an unlimited number of single-impulse photographs can be taken in succession without any parts requiring to be changed or reset. The intensity of the various impulses can be varied within wide limits by a regulating resistance.

It is obvious that the X-ray tube is subjected to much more severe treatment than in the case of the other methods hitherto used. In developing the single-impulse equipment, the problem of making an X-ray tube capable of withstanding these heavy current impulses had to be solved.

The X-ray tubes in general use at that date were more or less useless. Even the tubes with thickened platinum anti-cathode cannot stand more than a few flashes with the single-impulse equipment; either the platinum mirror is destroyed or the tube shows signs of being burnt in places. The latter causes blurred photographs, thus partly counterbalancing the advantages of the single-impulse method with its sharp heart radiographs. A sharp focus must, therefore, be insisted on.

It was found that the metal tungsten is a very suitable material for anti-cathodes as it has a higher melting-point than platinum and is a good conductor of heat, so that tubes in which this metal is employed are capable of withstanding the severe treatment to which they are subjected on the single-impulse method, and it was further found that these tubes can be provided with a sharp focus. Further, as a thick block of tungsten can be used as anti-cathode, such tungsten tubes have an almost unlimited life, whilst platinum tubes are destroyed after several flashes.

It was also observed that in consequence of the advantages mentioned above, the tungsten tubes give photographs which are richer in contrast and deeper than those obtained with tubes with platinum cathode.

The **Snook apparatus** was the first interrupterless machine made in a practical form for X-ray work, and was first introduced and made in England in 1907, the credit of the design being entirely due to Mr. H. Clyde Snook of Philadelphia.

The machine consists essentially of three parts: the motor converter, the high-tension transformer, and the high-tension rectifier or commu-

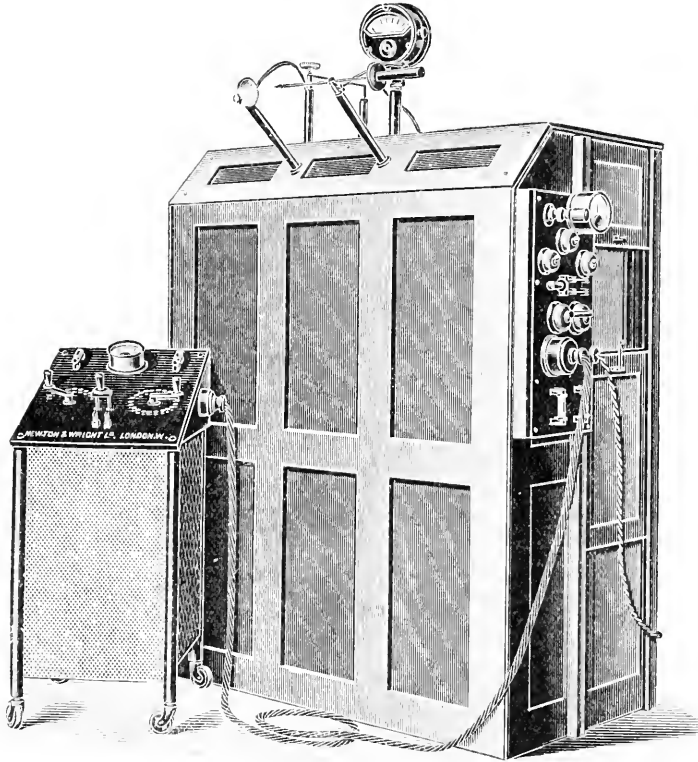

FIG. 4.—Snook apparatus. (Newton and Wright.)

tator. In the case of the machine designed to run on continuous current, the part first named consists of a motor usually about 4 k.w. in size, which runs from the main at about 1500 revolutions per minute. This machine has a pair of so-called slip rings, from which can be obtained an alternating current.

This alternating current is connected to the primary circuit of the transformer, through a controlling rheostat, and is raised in electrical pressure or voltage to the necessary tension for X-ray work.

This high-tension current is, however, alternating in character, whereas for the production of X-rays it is necessary to have a discharge in one direction only, and the latter is obtained by means of the high-tension rectifier.

This consists of a number of ebonite tubes, through which conductors pass, mounted on an axis, and rotated by the motor converter.

In revolving the conductors, connect the current from the secondary or high-tension side of the transformer to the spark-gap, to which the X-ray tube is finally connected, and also reverse the direction of the part of the alternating current, which would otherwise pass through the tube in the wrong direction.

The great feature of the machine is that this rectifier is carried on the shaft of the motor which is generating the initial alternating current by virtue of its rotation, and therefore the machine cannot get what is called "out of phase."

The general arrangement of the different parts is shown in the diagram below, and the whole mechanism is entirely enclosed in a cabinet of polished woodwork to deaden the otherwise disagreeable noise of the apparatus when in action.

If an alternating current is available, the motor converter is replaced by a small synchronous motor for rotating the rectifier, the main current being used in the transformer direct.

In this case the synchronous motor must be very carefully designed and constructed, otherwise it will cause trouble if there is any possibility of its running other than absolutely in step or synchronism with the current.

The apparatus is much preferred to an induction coil by many workers, owing to the possibility which it

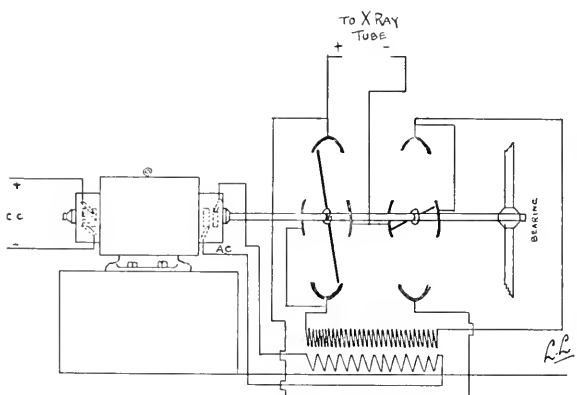

FIG. 5.—Diagram of Snook apparatus. (Newton and Wright.)

affords of using very heavy currents, enabling practically instantaneous radiograms of any part of the body to be taken, and also on account of the ease with which the current can be regulated.

The machine, moreover, produces a perfectly unidirectional current, entirely free from any inverse discharge in the wrong direction, which is a great advantage from the point of view of the life and general working condition of the X-ray tube.

## Accumulators

If no current from a main is available, accumulators may be used provided there is an opportunity of getting them recharged easily; but it must be understood that the time of exposure required will be much longer, because with twelve 2-volt accumulators we cannot produce the same intense discharge which can be produced with a 100- or 200-volt supply. If



there is no facility for recharging the accumulators, twelve or more large bichromate cells may be used ; but if the apparatus is required for use frequently, the recharging of bichromate cells is troublesome. In such circumstances other methods of obtaining a supply of current must be adopted, such as the use of a small gas engine and dynamo.

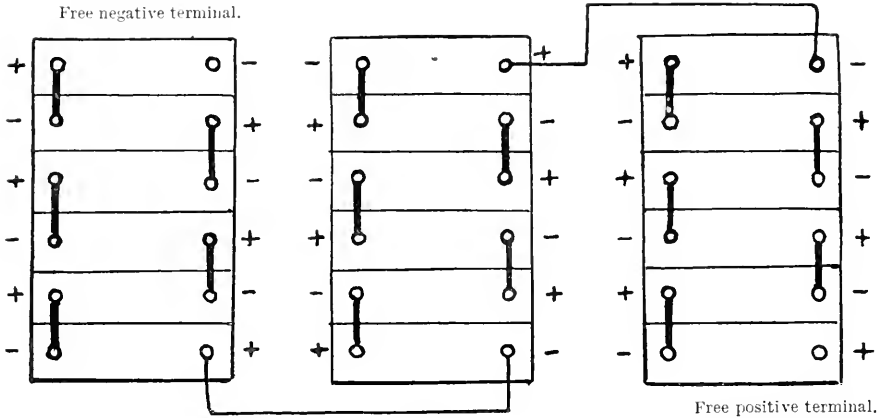

FIG. 6.—Accumulator connections. The positive wire going to the coil is connected up with the free positive terminal of the accumulators and the negative wire with the free negative terminal.

A practical point of some importance in the use of accumulators is to see that they are kept well charged and ready for use. It is also well to remember the mode of connection to the coil and break. The drawing above illustrates this point.

### Dynamos

A gas or oil engine can be used to drive a small dynamo. The oil motors

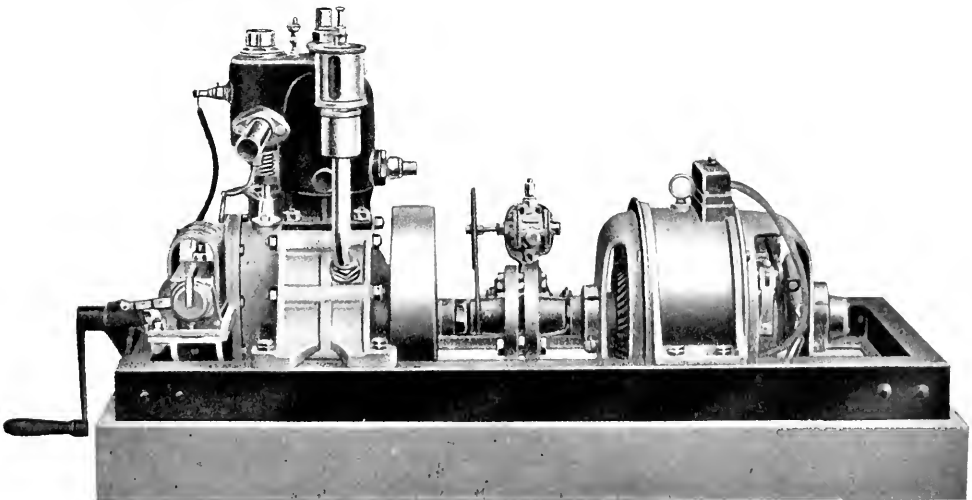

FIG. 7.—Gas Engine and Dynamo. Generator set with petrol engine. (Siemens.)

are similar to those used in automobiles ; they can be easily started, are small and portable.

It is hardly necessary to go into details of these outfits as the occasion for their use is rarely likely to occur except in remote country districts, or for military purposes.

## Motor Transformers

These transform the alternating current into a continuous one, a motor driven by an alternating current being coupled to a dynamo which delivers a continuous current. The size ought to be chosen so that at least 1000 to 2000 watts can be obtained from the dynamo. These motor transformers are very reliable, easy to work, and require scarcely any attention. The motor transformer should be placed on a solid bed-plate and well away from the X-ray room, as the noise they make is a constant source of annoyance to the operator.

Having briefly considered the sources of electric current the next step is to follow the process of utilising the current we have at hand, which is a low-tension one, and useless for the stimulation of an X-ray tube. Owing to the high resistance of such a tube, the 100- to 250-volt currents supplied on most mains cannot find a path through it.

The construction of the X-ray bulb is such that the current has to overcome a very high resistance between the two terminals, and it is necessary to have a high tension of 100,000 volts to do this. The low-tension current can, however, be converted into a high-tension one by transformation. A low-tension current of 100 volts may readily be changed into one of 100,000 by means of such a transformer.

The transformers most generally used are induction coils, and these will be considered first, though the tendency is increasing to use high-tension rectifiers for the production of powerful currents. These will be considered later. The necessary current may also be produced by means of the static machine. A large Wimshurst or Holz machine will produce enough current to work an X-ray tube.

## The Induction Coil

The primary coil may be divided into various windings in order to change the self-induction. These are connected up to terminals at one end of the coil and vary the quantity of current in the primary. They may be wired up to a switch-table and controlled from there, so that the operator may select the winding most suitable for the work required.

This arrangement, combined with a triple Wehnelt electrolytic interrupter, enables us to have a wide range of action to select from.

The essential parts of an induction coil are :

(a) A primary coil consisting of a number of thin sheets of metal or wire of a special magnetic iron round which a number of turns of thick copper wire are wound. This is placed in an ebonite tube to insulate it from the secondary coil. The thin sheets should also be insulated from each other.

(b) The secondary coil consists of many thousand turns of thin copper

wire wound in a number of thin vertical sections. A diagrammatic representation will best show the connections of the primary, secondary, condenser, and interrupter of an induction coil.

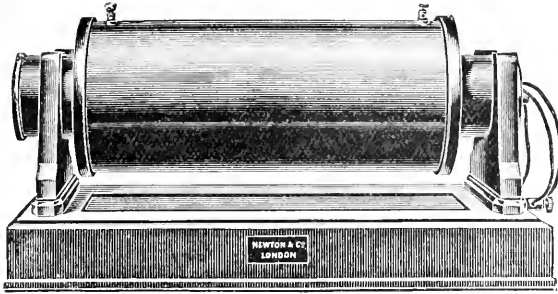

FIG. 8.—Induction coil, (Newton and Wright.)

T (Fig. 9) represents the iron core, P the primary or thick copper winding, P and T together forming the electro-magnet.

SS is the thin or secondary winding, which in nearly all modern large coils is now wound in a number of separate flat sections from end to end, each section insulated from the next by a partition of some insulating material, the sections being joined together alternately by their inner and

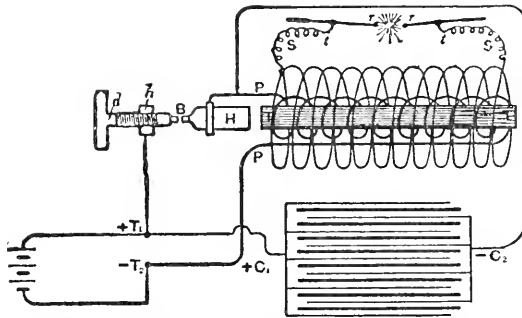

FIG. 9.—Plan of winding of coil, primary, secondary, and connection to condenser and break.

outer windings, so as to form one continuous helix the whole length of the coil.

Between the secondary SS and the primary winding PP is the insulating or primary tube, not shown in the diagram.

B represents the simplest pattern of contact breaker.

H is a piece of soft iron carried on a stiff brass spring, which is pulled towards the magnet T whenever the latter is magnetised.

B is a pair of platinum-tipped contacts, the front piece attached to the brass spring and iron pole piece H, the back one brazed to an adjoining screw *d*, working in a collar *h*, so that the distance between the platinum tips can readily be adjusted.

The current is passed from the positive pole of battery or mains into

the adjusting screw *d*, thence through the platinum contacts B, the primary winding PP, thence back to the negative pole T<sub>2</sub>. The circuit being completed, the core T becomes magnetised, the iron hammer H is attracted, and the platinum contacts are pulled apart, thus breaking the circuit.

The core thereby becoming demagnetised, the platinum contacts are pulled together again by means of the brass spring, and contact is again made, and the core T again magnetised, and so on. C is the condenser, the thin lines representing leaves of tin-foil, the thick ones insulating partitions of waxed or varnished paper.

When the contact at B is broken, the current passes into one side of the condenser at C, and by providing this alternative path the necessary sparking at B is greatly reduced, and, what is of much greater consequence, the suddenness of the break, and therefore the speed at which the core becomes demagnetised, is greatly increased.

A brief consideration of the construction and uses of a condenser will help to enable us to understand its action.

The condenser consists of a number of sheets of tin-foil which are insulated from one another by sheets of waxed paper, the condenser being usually enclosed in the base of the coil. The author usually insists on having two condensers connected to each coil in order to avoid delay, as should one become pierced, the other can quickly be connected up and work go on at once. This is rather an important point when a considerable amount of work has to be done.

The condensers should be placed in an easily accessible position to avoid delay in changing when one goes out of order.

**The electric motive force or spark length** increases with the number of turns of the secondary winding.

By choosing the number of turns it is possible to transform a primary current of 200 volts to 50,000 or 100,000, but the number of amperes is reduced in the same proportion because, though the numbers of the volts and amperes can be changed by transformation, the total energy can never be increased.

If the transformation could be effected without loss, a current of say 200 volts and 10 amperes could be transformed into 50,000 and 40 milliamperes, but as losses occur in every transformation of energy by friction, radiation, and conversion into heat, the current obtained under the above conditions will be between 25 and 30 milliamperes instead of reaching to 40 milliamperes.

To overcome the resistance of an air-gap of

4 inches	8 inches	12 inches	16 inches
110,000	150,000	190,000	230,000 volts

are necessary.

Coils are provided with sparking pillars. One of these has usually a point, while the other is provided with a plate. This arrangement is useful for the detection of the polarity. The sparks will discharge easily

from the point to any part of the plate when the latter is the negative pole as shown in Fig. 10.

When the point is the negative pole the sparks will discharge from the edge of the plate to the point as shown in Fig. 11, because the discharge would then be easier than from point to plate.



FIG. 10.—Connections of the X-Ray tube to the coil (Schall), showing the route travelled by the sparks when the point is the positive pole and the negative the plate.

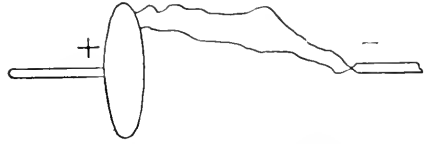

FIG. 11.—Connections of the X-Ray tube to the coil (Schall), showing the appearance when the poles are reversed.

When a current is sent through the primary winding the iron core becomes magnetised and a magnetic field is created.

The appearance or disappearance of the field, or any variation in its intensity, induces currents of short duration in the secondary coil, their intensity depending on the intensity of the magnetic field, and the suddenness of its appearance or disappearance.

To obtain X-rays of sufficient intensity for short exposures powerful coils have to be used. With such powerful discharges as are necessary for present-day work in hospitals and private practice it is much better to duplicate installations in order that the various exposures required for radiography and therapeutic purposes may be independently obtained to the best advantage. A coil outfit capable of giving instantaneous exposures is much too wasteful to use for the smaller discharges required for therapeutics, and when an attempt is made to combine the component parts of the installation so as to give these requirements from one and the same apparatus, something must be sacrificed, and no doubt this fact explains a good deal of the trouble that is experienced when using one installation for all purposes. A large outfit should be reserved for the radiographic work, a less powerful one for therapeutic work.

**Importance of the Condenser.**—Most coils are fitted with a condenser. This is absolutely necessary when the mercury interrupter is used. The condenser is connected in parallel with the interrupter, helping to reduce the spark appearing in the interrupter on breaking the primary current and to demagnetise the iron core rapidly; it is quite unnecessary when using electrolytic interrupters.

### The Control Apparatus

A switchboard or switch-table of some form is a necessity. This consists of marble or slate panels on which are mounted a main switch to turn the current on and off, and a variable resistance to control the intensity of the current.

In most cases the switchboard is provided with voltmeter and ampere-meter to measure the primary current, with a switch and rheostat to control the motor of the interrupter, a signal lamp to indicate whether they are turned on or off, and the necessary fuses and terminals.

In more elaborate installations the switchboard may be provided with a switch to allow the use of either a mercury or electrolytic interrupter, and the use of the anodes of the latter separately or connected in parallel; with a switch to change the self-induction of the primary coil; and with an automatic switch and time relay to break the primary current automatically after setting to a fixed time which can be varied from 0.05 to 10 seconds.

Single-impulse and similar forms of apparatus require a special automatic switch for use when giving the most rapid exposures.

The next point to consider at length is the question of the use of a rheostat, an instrument which enables us to vary the current supply to the primary coil.

Two forms of rheostat may be used, and it will be well to consider each in detail, as a clear knowledge of their use may prevent the operator from making mistakes, the cause of which he may have difficulty in understanding.

When using a series rheostat the full voltage of the supply is reduced to a very small extent, whereas by means of a shunt rheostat the voltage can be reduced and varied gradually.

This latter form has decided advantages if moderate or low pressures are required, because the variable voltage gives a better control over the discharge. With a shunt resistance the discharge can be varied in wide limits, and it can be better adapted to medium and soft tubes than is possible with the series connection.

As the amount of reverse current generated is in direct ratio to the voltage used in the primary coil, less reverse current is obtained with the lower voltage available with a shunt than with the higher voltage which is inseparable from the series connection. The tubes have, therefore, a longer life when used with the shunt connection, which is consequently more economical and to be preferred for all time exposures and for therapeutic purposes, or in other words whenever moderate or weak currents have to be used for a comparatively long time.

When short exposures are necessary the effects on the tubes must be to a large extent neglected, and the full voltage of the mains used, so that a larger milliamperage can be obtained in the tube circuit, and in all such cases the series connection with little or no resistance in the circuit is better than the shunt connection.

The objection to shunt rheostats is that they are wasteful, and more expensive, but after all the cost of electrical current is much less than that of tubes, which is undoubtedly increased when series rheostats are used. A complete switchboard should, therefore, have both methods of control.

It should be noted that some authorities do not agree entirely with the statements of comparison between the two forms of rheostats. A good

deal depends upon the construction of the coil and the interrupter, and the accuracy with which they are adjusted to one another. Other factors may also influence the degree of inverse current produced.

## The Interrupter

This important part of an X-ray outfit requires a lengthy consideration, and it will well repay the beginner to familiarise himself thoroughly with this part of his installation. He must know its construction, how to regulate it, and above all how to clean it when necessary. The interrupter serves the purpose of closing and opening the primary circuit. The sharper the opening of the primary circuit, the higher will be the tension of the secondary current—the opening induction current—and the greater therefore is the discharge.

For practical purposes there are two types of interrupters which require description. These are :

- (a) The Mercury Interrupter.
- (b) The Electrolytic Interrupter.

Of the former there are many varieties, but it will suffice to mention a few and give a short description of each before proceeding to the electrolytic type.

Probably the best all-round interrupter of the centrifugal mercury type is the Sanax, but this has one objectionable feature, viz. the trouble of cleaning it. The undoubted advantage which other forms of mercury interrupters possess over it is the ease with which they may be cleaned, and owing to the fact that gas is used in many as the dielectric instead of paraffin they require cleaning less frequently, and further the mercury never becomes emulsified. Practically every maker manufactures an interrupter of this type, and a general description will apply to all. The principle is the same in each—a mercury jet rotating in a vessel with a gas

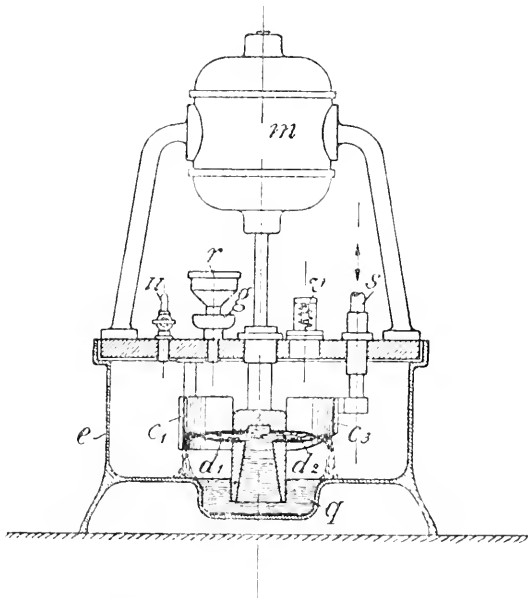

FIG. 12.—Diagram to illustrate construction of a centrifugal mercury interrupter. (Siemens.)

- |                                                                 |                                   |
|-----------------------------------------------------------------|-----------------------------------|
| <i>m</i> , Motor.                                               | <i>r</i> , Funnel for dielectric. |
| <i>c</i> <sup>1</sup> and <i>c</i> <sup>2</sup> , Contacts.     | <i>v</i> , Safety valve.          |
| <i>d</i> <sup>1</sup> and <i>d</i> <sup>2</sup> , Mercury jets. | <i>u</i> , Gas tap.               |
| <i>q</i> , Mercury.                                             | <i>v</i> , Containing vessel.     |
| <i>s</i> , Adjustable contact.                                  | <i>g</i> , Closing valve.         |

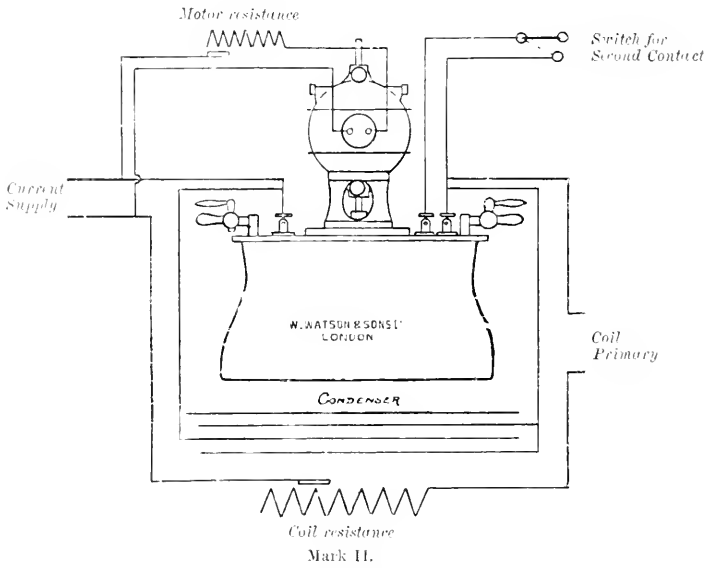
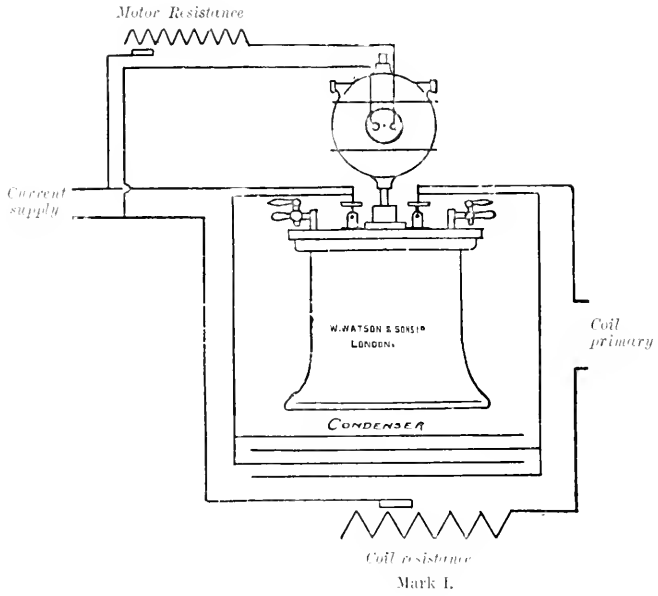

FIG. 13.—Plan of connections for Dreadnought interrupter.



di-electric. The gas supply may be obtained direct from the mains or a large rubber bag may be inflated with gas and attached to the tap on the interrupter. Fig. 12 illustrates the chief points of a mercury interrupter.

**Watson Dreadnought Interrupter.**—This interrupter consists of two parts, the interrupter proper and the motor for driving same. The latter is usually mounted on the top of the interrupter and can be removed by unscrewing a few milled nuts, and on lifting this top with the motor, one at the same time lifts out the rotating jet and the fixed contacts against which the mercury impinges, so making and breaking contact two or four times per revolution. The required amount of mercury is poured into the vessel and the top replaced and refixed. The interrupter is then connected to the coil and condenser and the motor to the supply mains. Most of these interrupters are provided with an arrangement of contacts and terminals, so that it is possible to double the number of primary interruptions, and so increase the effect in the secondary or tube circuit; other types have an adjustable wedge-shaped contact. Great attention should be paid to the cleanliness not only of the interrupter but also of the motor, and especially of the commutator and oil cups. To fill the interrupter with gas one tap is connected to the gas supply by a rubber tube and the other tap is left



FIG. 14.—Dreadnought interrupter. (Watson.)

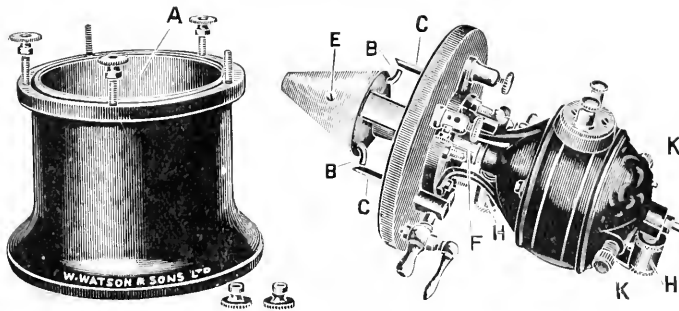

FIG. 15.—Dreadnought interrupter showing detail,

- |                   |                   |
|-------------------|-------------------|
| A, Container.     | F, Shaft bearing. |
| B, Jet.           | H, Oil cups.      |
| C, Contact teeth. | K, Motor brushes. |
| E, Screw.         |                   |

open for a few moments in order to expel the air. This tap is then closed and the other connected to the gas supply left open, and advantage taken of the pressure from the mains. If there is no handy gas supply a gas bag may be used or ether vapour. The latter may be employed by vaporising a small quantity of methylated ether placed on the top of the mercury and starting the interrupter with a small current before closing the taps.

In the **Instanta interrupter** and others there is an arrangement of four jets so that eight makes and breaks are obtained per revolution, and it is also so arranged that the circuit is broken in two different places at the same moment. This has the effect of greatly increasing the suddenness of the interruption.



FIG. 16.—Instanta interrupter.

The **Sanax Interrupter**. — The Sanax interrupter consists of a small steel pear-shaped bowl mounted direct to the axle of an electric-motor and situated perpendicularly above the motor. Thus, when the axle of the motor rotates, the pear-shaped bowl is rotated also. Inside the bowl a very small quantity of mercury (only 10 oz. weight) is placed, and, by centrifugal force, travels up the side of the bowl until it finds the extreme periphery, where a distinct groove or bed is made to receive it. Thus it will be seen we have a revolving bowl and in it a revolving ring of mercury. Inside the interrupter bowl and carried on a vertical spindle is a fibre disc with two copper segments. This disc is mounted, free to revolve, on ball-bearings top and bottom, and is horizontal in position. It is not placed in the centre of the bowl, but over to one side, so that when the bowl rotates its edge engages with the rotating ring of mercury and is, therefore, of course, revolved by it. The current is led to the metal bowl and to the mercury ring by means of an ordinary terminal, and the current is led also to the segment in the disc by means of the spindle carrying same. Thus, each time one of the copper segments enters into the mercury ring the current is allowed to pass, and each time the segment leaves the mercury ring and the fibre of the disc enters the ring, there is an interruption period.

By the unique construction of working two circles together—the mercury ring and the fibre segmented disc—a splitting up of the mercury, such as would occur by plunging into the mercury any other form of contact, is completely avoided.

As already mentioned, the free revolving fibre disc with two copper segments is placed not in the centre of the bowl, but eccentrically, and can be inserted more or less into the mercury ring from the outside, even if the motor is running. This arrangement makes it possible to put the disc so that it just touches the mercury ring, in which case the duration of contact is very short. The further the disc is put into



FIG. 17.  
Sanax interrupter.

the mercury ring the further the segment travels in the mercury, and therefore the duration of contact can be extended as desired. Moreover, the number of interruptions is regulated by the speed of the motor by a special volt regulator mounted on the switchboard, so that not only is the duration of contact independent of the number of interruptions, but both are also independent of the primary current.

*The Di-electric* used in the Sanax interrupter is paraffin. Alcohol, gas, and other di-electrics have been tried, but paraffin has given the best results.

Before the introduction of the Sanax interrupter the mercury interrupters using paraffin as a di-electric, in spite of their numerous advantages, had the great disadvantage of emulsifying the mercury. The cause of this is not the burning of the same by the opening spark but the mechanical breaking up and churning of it with the di-electric. After working the mercury interrupter for a short time it was imperative to remove the dirty mercury and to clean it—a very disagreeable and troublesome proceeding. The ingenious principle of the Sanax interrupter—the working together of the two circles in unison and the continuous centrifugal rotation—delays the emulsification of mercury. In consequence of its greater specific weight the mercury is always driven to the farthest outside point and disintegrates by itself all the lighter substances, therefore remaining for a longer or shorter time, according to the amount of usage, clean at the point of interruption.

*The Number of Interruptions* can be increased up to about 12,000 per minute. By means of a turning switch on the switchboard the motor can be run fast or slow, and further, by means of a resistance, it is possible to run the motor at any desired speed, thus obtaining any number of interruptions.

*Causes of Defective Working.*—A few short hints on the causes of defective working may be of assistance to workers. If when switching on the motor it does not start up, the speed regulator should be at once cut out, and then the motor having started, it can be brought back to the position of usual working. There also may be an interruption or short circuit in the main cable leading to the switchboard or table, or the cables leading to the motor of the interrupter may have become loosened, or the brushes and their screws may have become loose, all of which faults would be indicated by the motor refusing to start. If the commutator starts to spark after running some time it will be found that this is generally due to oil and carbon dust, and this must be removed by cleaning the commutator with fine emery cloth, and also cleaning the carbon brushes. If when the coil is now switched on we observe no light in the X-ray tube, this may be due to the fuse having been burnt through or become loosened. Great care must be taken to see that all bearing contacts are clean, that all cables are perfect, and that all terminals are absolutely secure.

Should the tube give an unsteady fluorescence this may be due to some extent to the vacuum of the tube, and can be controlled somewhat by adjusting the interrupter. If the tube flickers with a contact of a certain size,

the tube may be steadied by increasing this contact. This flickering may be also due to the motor of the interrupter running slowly. Another reason for this effect in the tube may be the piercing of the condenser, and this can be detected by testing the spark length of the coil. If one cannot obtain the full spark length and the primary current is above the normal, then the condenser should be carefully examined. Finally the copper contacts of all interrupters need replacing from time to time, as they become burnt through from long usage, this leading to bad and intermittent working.

**Improved Mackenzie Davidson Interrupter.**—This is a useful form of mercury interrupter when an outfit of moderate capacity is all that is required, and when accumulators are used as the source of supply.

It consists of a metal pot containing a supply of mercury into which a contact set at an angle dips. This contact is mounted on the end of the

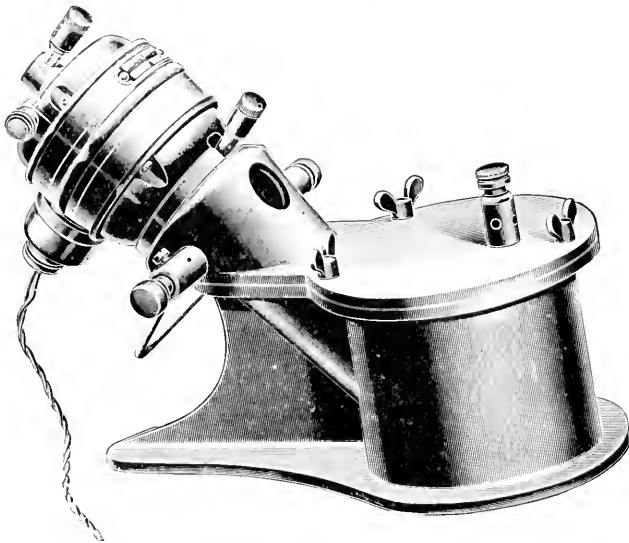

FIG. 18.—Improved Mackenzie Davidson interrupter. (Schall.)

shaft of a motor whose speed can be varied in order to vary the number of interruptions. This interrupter requires rather more mercury than most of the other types.

**Electrolytic Interrupter.**—This type was introduced by Professor Wehnelt. The principle of construction is simple. A platinum wire and a large lead electrode are immersed in diluted sulphuric acid in the proportion of acid 1 oz. to 5 oz. of water.

This interrupter is without doubt a good one, far exceeding the best mercury interrupters, not only in regard to output and capacity for regulation, but also in simplicity of construction and use, as well as in safety of working. Wehnelt interrupters can be used wherever continuous current is supplied direct, *i.e.* from supply mains, accumulators (at least about 65 volts), or a motor generator, or where single-phase or three-phase current is converted into continuous current by means of rotary converters or

electrolytic valves. As all metals, with the exception of platinum, when used for the active electrode, even if the polarity is correct, are rapidly con-

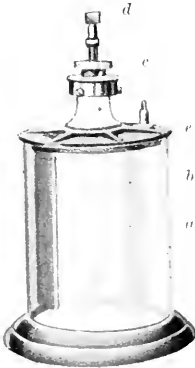

FIG. 19.—Single-point electrolytic interrupter. (Siemens.)

*a*, Glass vessel.  
*b*, Porcelain diaphragm.  
*c*, Adjustable ebonite collar.  
*d*, Terminal. *e*, Lead electrode.

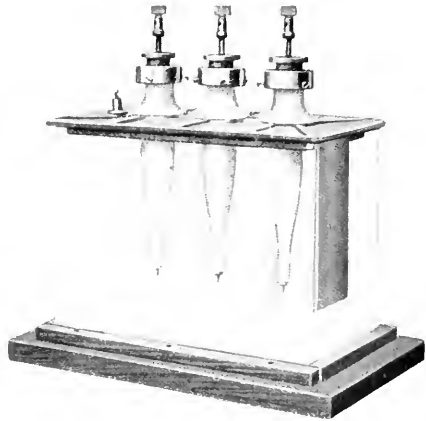

FIG. 20.—Three-point electrolytic interrupter. (Siemens.)

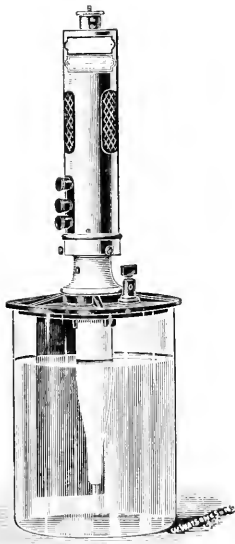

FIG. 21.—Single-point electrolytic interrupter. (Watson.)

The upper part of the interrupter has attached to it a solenoid which is connected electrically to the switch-table, allowing of the control of the depth of point in the fluid.

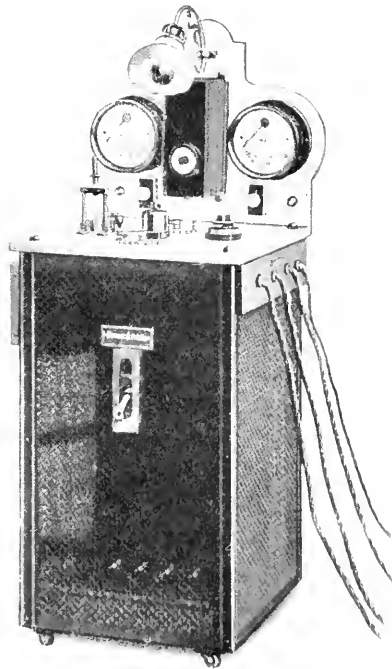

FIG. 22.—Trolley control table, with resistances arranged to facilitate time and rapid exposures. (Siemens.)

sumed, platinum is always used with these interrupters as the active electrode, because it disintegrates very slowly and therefore gives the best results.

These interrupters are manufactured with 1, 2, 3, 4, or 6 separate electrodes, *i.e.* they are used as single, double, triple, quadruple, or sextuple interrupters. When employing a multiple interrupter one is not obliged to regulate at the interrupter itself, and can therefore set it up outside the X-ray room, so that its noise causes no disturbance.

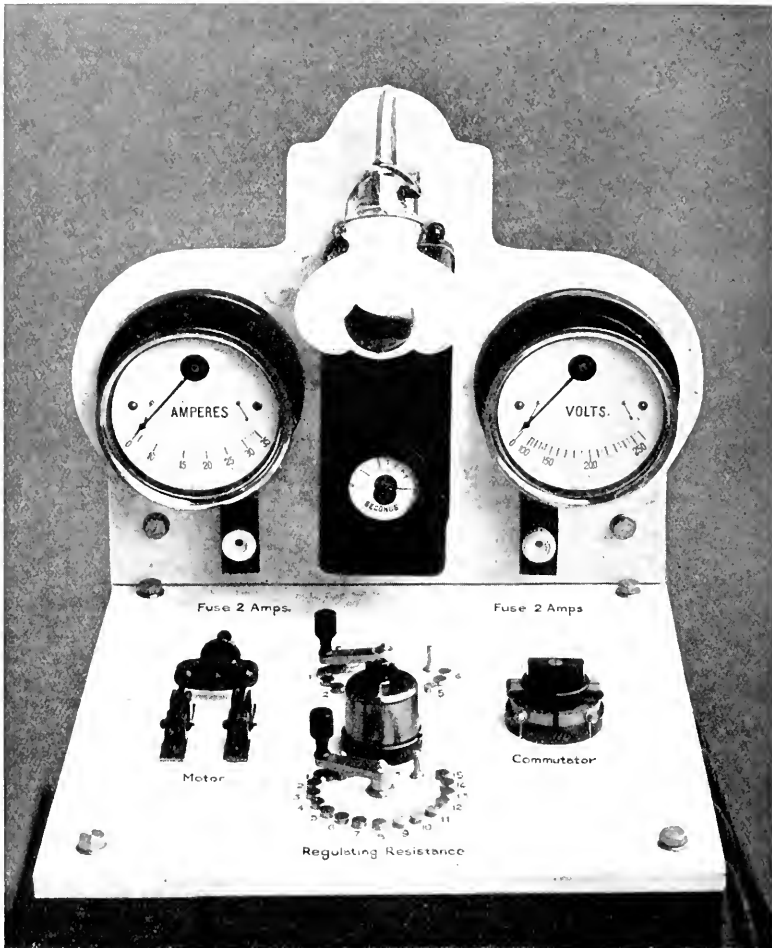

FIG. 23.—Larger view of top of trolley control table to show the regulating parts. (Siemens.)

The advantages of the Wehnelt interrupter are summarised briefly as follows :

- (1) Simplicity of construction.
- (2) Convenient handling of the X-ray outfit. The Wehnelt interrupter requires no attention.
- (3) Largest capacity, as it interrupts very rapidly the largest amount of energy and therefore the most intense X-rays are obtained.
- (4) Long life to the tubes even when used with heavy currents.
- (5) In comparison with all mechanical interrupters, great reliability.

This is due to its simplicity of construction and method of working, the absence of moving parts, and the consequent simplicity of connections of the whole outfit.

In the case of X-ray outfits for rapid exposures three or more electrodes are arranged in parallel by means of a switch, and the electrodes are so adjusted that equal parts of them interrupt the total current.

In conjunction with a time-relay switch these interrupters can be used to obtain exposures of from  $\frac{1}{10}$  to 6 seconds in connection with an automatic cut-out switch. Such a device is illustrated opposite. With the most powerful induction coil outfit, such as the single-impulse apparatus constructed for use with the electrolytic interrupter, a time-relay should always be included, along with a triple electrolytic break, for then we have a large range of exposures at our command.

**Method of Action of an Electrolytic Interrupter.**—When a current of at least 50 volts and 5 amperes is passing through the interrupter in such a manner that the platinum is the anode, the density of the current is so great near the small anode that it becomes very hot and steam is formed. In addition, electrolysis causes hydrogen and oxygen to appear, and these gases form an insulating mantle round the anode which interrupts the current. If there is a sufficient amount of self-induction in the circuit, a spark appears at the breaking point, namely the anode, ignites the gases, and the explosion gives the acid access to the platinum, thus closing the current again. This process takes place with extraordinary rapidity and regularity.

The intensity of the discharges and the frequency of the interruptions can be varied in the widest limits by varying the electro-motive force used in the primary circuit, the surface of the platinum anode, and the amount of self-induction.

The *disadvantage* of the electrolytic interrupter is the great care that has to be exercised in its use. Unless a considerable latitude is allowed for, the X-ray tube is more likely to be damaged, the anti-cathode being quickly pierced if too powerful currents are used for long periods. When, however, the electrolytic interrupter is provided with three or more points and a suitable switch on the general or main switchboard, all degrees of exposure can be successfully used. Even for therapeutic work this interrupter when properly used is undoubtedly one of the best forms of interrupter.

With a time-relay switch most powerful currents may be used if only for a fraction of a second.

Carelessness in leaving the thicker points in the circuit and then using it for prolonged screening will almost invariably ruin a tube.

A single-point electrolytic interrupter can be controlled from a distant point by means of a solenoid. In this way it is possible to vary the depth of the platinum point in the acid solution and so vary the intensity of the current passing through the interrupter. This is a most useful addition to the electrolytic interrupter.

**Interrupters for Alternating Currents.**—These are numerous,

mechanical and chemical, and enable us to use the alternating current without rectification.

Good though some of these are, none is so efficient as an interrupter on a continuous current circuit, and the maximum intensity which can be reached even with the best alternating current interrupter is much less than that obtainable with a continuous current.

When the alternating supply has a higher periodicity than sixty it is better to rectify the current by installing a motor transformer.

With a periodicity of less than sixty the best interrupter to use is that made by Gaiffe of Paris. This interrupter and a Gaiffe Rochefort transformer or coil may be used for therapeutic work by utilising less of the break, but

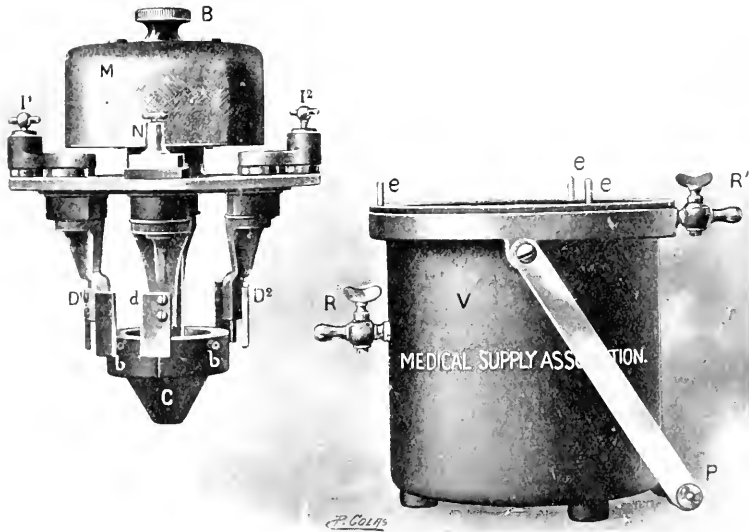

FIG. 24.—Gaiffe interrupter.

V, Vessel.	M, Vulcanite cap.	R, Inlet tap.	$b, b^1, b^2$ , Orifices.
$e, e^1, e^2$ , Screws.	B, Impulse.	R', Outlet tap.	$d, d^1, d^2$ , Teeth.
I¹, I², X, Terminals.	P, Handle.	C, Cone.	

when required for radiography the intense current is used. This is done by a mechanical contrivance which throws all the teeth in the interrupter into action. Quite rapid exposures may be obtained with this apparatus especially if intensifying screens are used.

The mercury jet is caused, as in some of the previous interrupters, by the rotation of a cone with its lower end in mercury, and by centrifugal force the mercury is jetted out against the stationary contacts. The motor part differs from the continuous current interrupter. The break is started with a smart twist of the milled head on top and the needle of the milliammeter watched until this is steady, this indicating that the interrupter is in synchronism with the supply. Some operators can judge of this by sound. At first there is a grating sound, and this becomes smooth when synchronism is attained.



The essentials for the production of X-rays are : (a) A supply of electric energy ; (b) a means of transforming a current of low tension into one of high tension ; (c) an interrupter ; (d) an X-ray bulb.

The apparatus employed may vary from the simplest to the most highly complicated. Its selection and arrangement will depend upon the operator and the resources at his command. Complicated and expensive apparatus is not absolutely essential to ensure the production of good negatives. The most important point of all is for the operator to make the most of the apparatus at his disposal. When he grasps the underlying principles of the necessary apparatus, and particularly of the technique of radiography, he may venture to add to his outfit those items which are extremely useful but not absolutely necessary. A thorough understanding of the mechanical parts of the installation is of great value to the radiographer, but is not absolutely necessary, because it is generally possible to obtain help in the manipulation of the apparatus. But a thorough knowledge of the X-ray tube is of the utmost importance, because it is always the ruling factor in radiography and therapeutics. In order to produce the best quality of X-rays for a specific purpose in either radiography or therapeutics it is necessary to have accessory apparatus which enables the operator not only to control the X-ray tube but to reproduce at will conditions which are known to lead to the production of good results.

The accessory apparatus is therefore a most important part of the equipment, and must be considered in detail. In the whole organisation of an X-ray outfit the most important point is to have a good X-ray tube under perfect control, then work becomes easy and good results follow.

In view of the importance of this subject the following pages are devoted to a fairly full account of the manufacture of an X-ray tube and the apparatus necessary to enable the operator to exercise an efficient control over it.

# X-RAY TUBES AND THEIR ACCESSORIES

## The Focus Tube

This being always the ruling factor in radiographic work, a complete knowledge of its construction and method of working is a *sine qua non* in the routine work. Should it not be in proper order the best type of apparatus is quite useless as a producer of good radiographs.

The quality of the focus tube is all important for success in X-ray work,

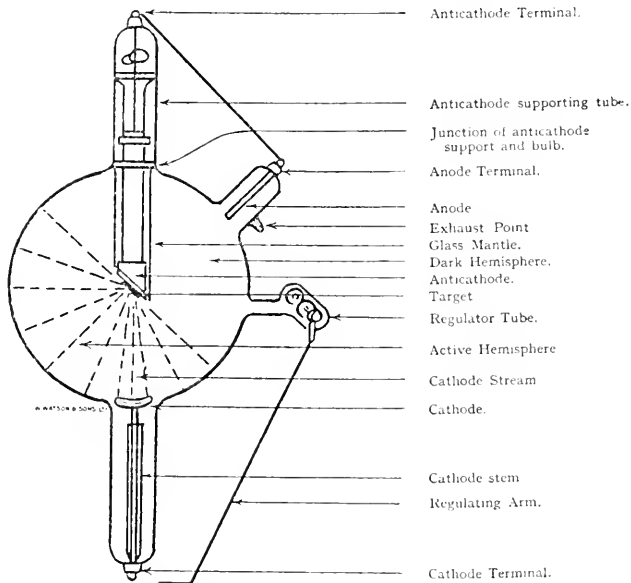

FIG. 25.—Diagram of an X-ray tube with parts named, showing the paths of the cathode stream from the cathode impinging on the anti-cathode; the active hemisphere shows the paths of most of the X-rays generated. (Watson).

as if the tube is unsuitable in that it is too hard or too soft, it is impossible to get good results.

If, on the other hand, the tube is in good order good results may be obtained with quite ordinary apparatus.

Tubes deteriorate with use, but, carefully handled, they will outlast hundreds of exposures, and show very little sign of damage.

The all-essential point is to know how to use the focus tube, and it is

also a great advantage to familiarise one's self with the names of the various parts.

**Description of the Manufacture of an X-Ray Tube.**—The first process consists of the blowing of a glass sphere of the desired capacity with a "neck," which varies from one to two inches diameter, according to the size and type of the tube. The thickness of the walls of the bulb is from .2 to .6 mm.

The various metal parts, or electrodes, having been carefully cleaned, are introduced through this neck, and are in turn sealed into position by the glass-blower. Connections are made to the outside by fusing into the glass pieces of platinum wire, and as each portion of the tube is finished, it is annealed with extraordinary care. This annealing is one of the most important processes, as an X-ray tube has to withstand the most intense heat,

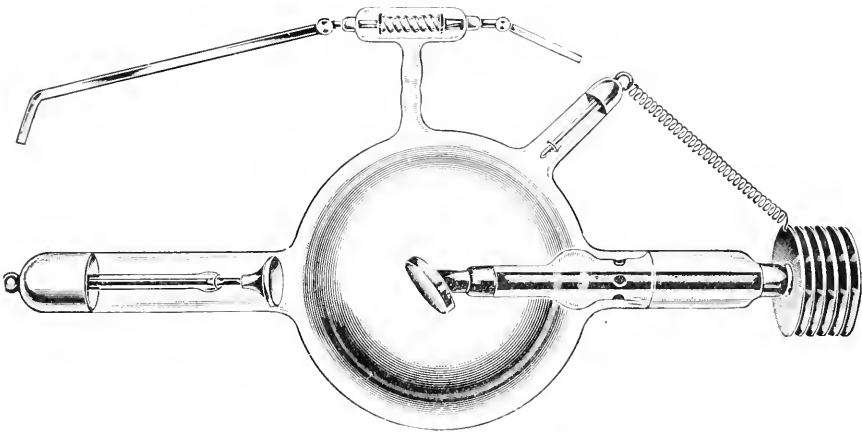

FIG. 26.—Radiator tube constructed for heavy discharges. (Cossar.)

to say nothing of the rough usage which it may encounter if it is destined for a hospital career.

The electrodes having been placed in position, and the regulators, etc., attached, a length of glass tubing is fused on, and the tube is placed on the vacuum pump. The final stages of exhaustion are sometimes very prolonged, varying according to the size of the tube and the nature of the electrodes employed.

A large tube may occupy a considerable time in actual exhaustion. During the process various conditions have to be observed, and it is during pumping that the unavoidable risks of tube-making are greatest, as with the increase of pressure from without, any stress, flaw, or other fault may result in the sudden collapse of the tube.

When exhaustion is complete, the tube is taken from the pump, sealed, tested, and, if found to be in order, is finished off with the necessary terminals.

**The Anti-cathode.**—The most important part of an X-ray tube is the anti-cathode, since it is here that the heat is generated, and most dis-

turbances take place. It is this part of the tube which is exposed to the intense force of the cathode stream.

The power of resistance to this stream, and the physical effect thereof, possessed by the anti-cathode of the tube is the determining factor in the life of the X-ray tube, and the degree of current it will stand determines largely the amount of work it is capable of performing.

Naturally the anti-cathode varies with each tube, and these are now made for special purposes.

A careful study of the various types of anti-cathode in use will be necessary before the operator can thoroughly understand the best conditions under which the tube will work. The anti-cathodes of some tubes may become incandescent when the tube is running at full current, and a careful watch is necessary when using tubes in this way.

The cheaper tubes are made with light anti-cathodes. The next class of anti-cathode is that known as the "heavy anode," consisting usually of a copper tube or sleeve of varying thickness and length, and carrying at its extremity a platinum-coated plate similar to that used in the light anode tube. In this case, however, these various metals are welded together into one continuous whole, which is

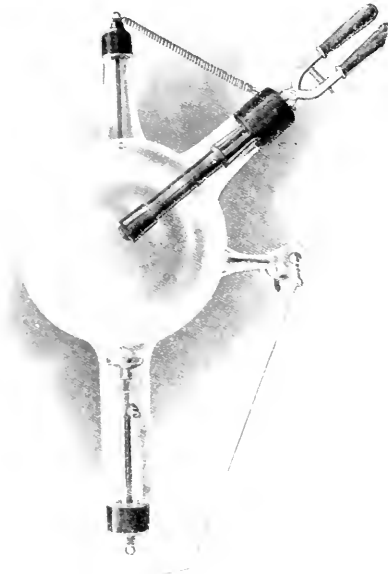

FIG. 27.—Cyclops radiator tube. (C. Andrews.)

The heat generated at the anti-cathode is absorbed and radiated along a solid copper rod which is arranged to facilitate ready removal from the tube. When the copper is heated it may be removed and a second one introduced. By changing these during an exposure, the tube can be kept comparatively cool for long periods, the vacuum of the tube being thereby maintained at a constant degree of hardness.

supported on a glass sleeve projecting from the wall of the tube. Naturally this mass of metal has much greater absorption and conductive capacity than the light anode, and will in consequence stand a much greater degree of heating, *i.e.* a higher current. There is also a proportionately large reserve of gas in these armatures, and, unless grossly over-run, such tubes do not become red-hot, and are therefore much more constant in vacuum.

As the weight of metal in the anti-cathode is increased, so (other conditions being equal) the capacity of the tube to withstand a high current is increased also. Occasionally, the metal sleeve of the anti-cathode is greatly extended, and is carried directly to the exterior of the tube, terminating

sometimes in a radiating device in order to discharge the heat as expeditiously as possible.

As the difficulties which arise in heavy currents for X-ray work are almost wholly concerned with such heating, several other methods have been adopted in order to deal with it in an efficient manner. One is the system on which the Cyclops tube is worked. The other is that employed in water-cooled models. These are described at some length in the following pages.

**Water-cooled Tubes.**—The general use of X-ray tubes cooled by means of water was, for all practical purposes, commenced by the continental radiographers.

The original Müller water-cooled tube is designed mainly on the lines suggested by Professor Walter. It is arranged in the following manner: In place of the usual heavy metal anti-cathode, a solid platinum vessel is provided, and on to the bottom surface of this is fixed a metal plate which is in turn faced with platinum. The upper or open end of the vessel is sealed on to a glass sleeve, which is in turn attached to the wall of the tube, and which is expanded, outside the tube, into a reservoir or water chamber approximately 3 inches diameter. When water is filled in, it passes down the glass sleeve to the platinum vessel, and is thus brought into actual contact with the back of the target. This latter feature is an essential in the

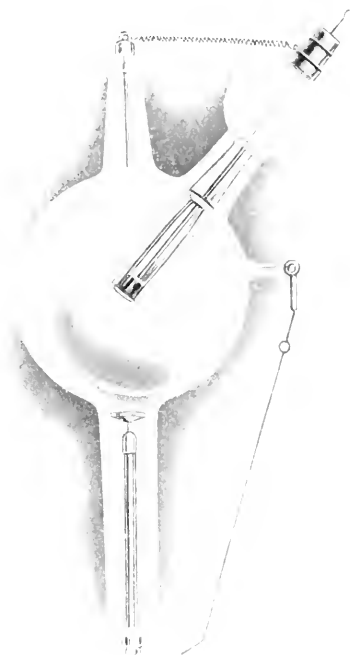

FIG. 28.—Water-cooled tube arranged for overhead work. (C. Andrews.)

construction of a water-cooled tube. Workers are strongly advised not to purchase so-called water-cooled tubes when the water does not reach right down to the back of the target, as such instruments simply omit the vital principle which renders the water-cooled tube so highly efficient.

When the heat is generated by the impact on the target it is immediately imparted to the water, and the temperature of the target can therefore only momentarily exceed that of boiling water— $100^{\circ}$  C.

Apart from the efficiency of the cooling system, the construction of water-cooled tubes renders them more satisfactory in other respects. In the first place it is possible to make the anti-cathode almost entirely of platinum, which means that there is practically no metal in the tube likely to give rise to violent changes of vacuum. The water-cooled tubes remain

therefore at approximately the same degree of hardness for very long periods. The great advantage in this respect cannot be over-estimated, and will appeal both to those who are doing continuous radiographic work, and to those running tubes for long periods for therapeutic purposes. The latter point is of extreme importance for deep therapeutics.

The employment of water as a cooling medium is free from all objection, even from that of extra trouble in manipulation; for if tubes, when not actually running, are stored in one of the excellent vertical holders now on the market, it is not necessary even to empty the water bulb after use, and the only extra attention entailed is the occasional replacing of the water which may be lost by evaporation.

The principal feature of water-cooled tubes is that they may be kept in continual use for hours, without any danger of over-heating and consequent

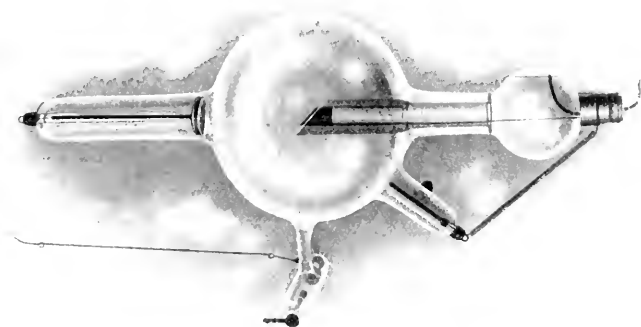

FIG. 29.—Water-cooled tube for overhead or under the couch work, showing mica and carbon regulator. (C. Andrews.)

softening. Further, they will withstand a much larger current than the ordinary tube will take, and in fact the heavier models will for a short time stand up against the maximum amount of current which can be forced through them.

*Selection.*—In selecting a water-cooled tube, regard must be paid to the class of work which is intended to be done. It must be considered whether the tube is to be used with light or heavy currents, and whether it is to be used only above the couch (either horizontally or vertically), or whether it is desired that it may be used in the horizontal position from below the couch.

The tubes for use below the couch are made with the anti-cathode set in the long axis, and are furnished with a curved revolving tube, by means of which the water is prevented from flowing out. The tubes for use in positions other than below the couch have the anti-cathode set at an angle of  $45^\circ$  to the long axis.

Tubes for use with heavier currents are made on an exactly similar

system to the lighter models, but differ in that the armatures are strengthened in order to permit of the heavier loads being carried. The most important modification is in the anti-cathode, which is made in the following way: The platinum-faced target is set on a massive block of specially alloyed copper, which is in turn attached to a solid platinum vessel similar to that used for the lighter models. By the interposition of this buffer of alloy the capacity of the tube is enormously increased, and at the same time the amount of extra metal thus introduced is not sufficient to rob the tube of its excellent qualities of constancy and steady working. In fact the whole proportioning and "balance" of these tubes has been worked out with a nice exactness which has been amply justified by the result.

*The Use of Water-cooled Tubes.*—It must be remembered that this type of tube is designed and constructed to work with a water-jacket, and it must on no account be used without the receptacle having been filled to within about half an inch of the top. In the case of the pattern for use above and below the patient, the opening of the curved tube should be just above the surface of the water, when the instrument is placed horizontally, thus allowing an outlet for steam. If the tube should be inadvertently worked without water, it must be allowed to cool completely down (say, for at least an hour) before water is filled in. If this precaution is not observed, a breakage will in all probability occur.

As stated above, it is not necessary to remove the water after using, and, therefore, there should be little danger of the tube being worked without the cooling medium.

Ordinary tap water should be employed, not distilled nor filtered. Should the tube have been running continuously so that the water is boiling, it is permissible to renew the supply, and this may be done without disturbing the tube, by means of a syphon. By placing a vessel containing water at a lower level than the tube and starting the flow by suction, the water may be run out until only about 3 inches of the water-tube remain filled. The container is then raised to a level above the tube, and water allowed to flow in. If no syphon is obtainable, an alternative method is the following: Pour the boiling water out of the tube into a jug, and add cold water in sufficient quantity to render the whole just distinctly warm to the touch. Then refill the water-chamber with the slightly-warmed water. Obviously, if the boiling water were removed, and cold water filled in, the glass might possibly fracture; but by adopting the above method the supply may be safely renewed. The tube may then be run as before.

In cases where the tubes are used in a horizontal position, care should be taken to raise the water-chamber slightly above the level of the anti-cathode itself, so as to keep the water against the target. This prevents the water flowing away from the anti-cathode, as it might do if the tube were absolutely horizontal, and also allows of the escape of bubbles, etc. The curved tube in the cap may be revolved according to the position of the X-ray tube, so as to permit of the aperture being always uppermost.

If desired, the water can be circulated through the tube by means of the

syphon mentioned above. This is very efficacious, but necessary only when very lengthy runs are being undertaken.

There is another type of tube made by several makers which is very efficient and convenient for treatment. This tube has a diameter of about 5 inches (125 mm.). As will be seen from Fig. 215, p. 295, an auxiliary bulb (having a diameter of about  $6\frac{1}{2}$  inches) is connected to the tube, thus forming a reserve air-chamber. This construction results in the tube possessing all the advantages inseparable from one having a large cubic capacity; while the fact of the anti-cathode being only  $2\frac{1}{2}$  inches from the wall of the tube enables the original Sabouraud distance to be adopted.

**Air-cooled Tube.**—The tube employed is specially constructed, an air pump being employed to supply a forced draught which is sent

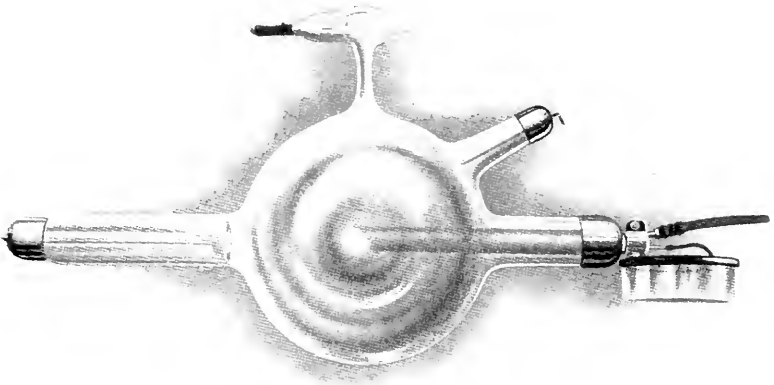

FIG. 30.—Desneur tube with atomiser for cooling the anti-cathode. (Siemens.)  
This tube is specially exhausted for deep therapeutic work.

into the cathode and anti-cathode of the tube. By means of the small electric motor operating the force-pump, air at the temperature of the room is used at considerable pressure. The special modifications of the tube required are as follows: In place of the ordinary cathode there is employed a very massive hollow armature, with the same diameter as the anti-cathode; into both cathode and anti-cathode are fitted inlet tubes, which bring the cold air into direct contact with the whole inner surface of the armature, and the heated air is expelled through a number of peripheral apertures. The connection between the X-ray tube and the air pump is made by means of strong india-rubber tubes. The cathode is cooled as efficiently as the anti-cathode, this being a very important point. In a tube of this type, currents of at least 5 to 7 milliamperes may be passed continuously without any ill effects.

There has been introduced a further elaboration of this type of tube, *i.e.* a tube working as described above but fitted in addition with an atomiser connected to a vessel containing water. Instead, therefore, of air being



pumped on the back of the anti-cathode the water is continuously sprayed on the latter and thus cools the electrodes.



FIG. 31.—Heavy anode tube (Gundelach). Osmosis regulator. (Siemens.)

**Gundelach Tube.**—The tube figured above is the ordinary Gundelach tube with Osmosis regulator. There has just been introduced a new tube by Gundelach which appears to possess some special advantages for deep therapeutic work. It is not of the usual outward form but cone-shaped, with the anti-cathode near the point of the cone and the terminals and regulator at the base, so that the tube can be brought very near to the part to be irradiated, and at the same time the high-tension terminals are some distance away. Further, the tube is made to be used in a specially thick lead-glass shield with a celluloid window, and on the outside of the window is an arrangement for attaching aluminium filters of various thicknesses. The tube is arranged for air-cooling by means of a forced air-pump, and two feeding tubes from the pump are arranged so that one is connected to the pipe leading to the back of the anti-cathode, and the other to the inside of the protective lead-glass shield in order to keep the outside of the tube cool. The pump connections are worthy of notice, the particular feature being that the air is fed from the pump to a water-cooling chamber, which is essential for successful cooling, otherwise it will be found that the air, after the pump has been running for some time, becomes warm, but after passing through the cooler it is reduced to the temperature of the room, and will remain at this temperature for hours without changing the water. With such a tube and air-pump combination it is possible to work for considerable periods with large milliamperages.

**Coolidge Tube.**—At the time of writing this book an announcement comes from America of a tube which has been invented by D. D. Coolidge, which appears to be of such novel construction as to make it the greatest advance that has taken place since the discovery of X-rays.

The tube is devised to be entirely free of gas and has a vacuum 1000 times greater than the ordinary tube, so that it is impossible to pass a current through it in the ordinary way even with the most powerful apparatus. The anti-cathode is constructed of tungsten, and the cathode, instead of

being an aluminium cup-shaped electrode, consists of a spiral of tungsten wire surrounded by a sleeve of molybdenum to focus the cathode stream. Connected to the cathode spiral is an auxiliary source of current consisting of a small accumulator battery with an ammeter in circuit (it is important that the battery is well insulated from earth), which heats the metal, causing it to give off a stream of negatively-charged electrons which are projected on to the anti-cathode.

The number of freed electrons from the anti-cathode is regulated by the degree of heating of the tungsten spiral, and the speed of the cathode



FIG. 32.—Coolidge X-ray tube. (British Thomson Houston.)

stream, upon which depends the penetrating power of the X-rays, is regulated by increasing or diminishing the potential at the terminals of the tube.

It is claimed, therefore, that this tube will give us accuracy of adjustment, stability of hardness, possibility of exact duplication of results, unlimited life, great range of flexibility, absence of inverse radiation, and extremely large output. The chief feature seems to be that one can at will

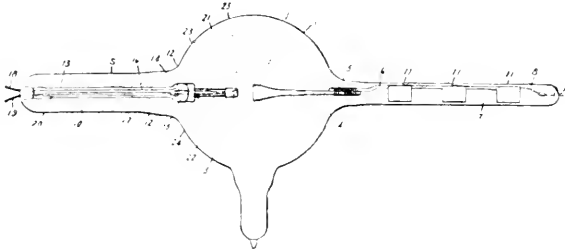

FIG. 33.—Diagram of Coolidge tube.

have any degree of hardness, and any quantity of rays, and these two factors constant for indefinite periods, and can also repeat the same conditions at any time. The most remarkable and valuable advantage is that indicated by its immense output for deep therapeutic work, and also for instantaneous radiography. There is one note of warning, and that is that this tube gives little or no visible sign of fluorescence, so that extra precautions must be taken; otherwise, owing to its much greater output, a serious burn can be produced, the margin of safety being practically nil, whereas one cannot run the ordinary form of tube continuously with a heavy current.

*Connections.*—The accompanying illustration shows the tube properly connected to the storage battery and the terminals from the coils. *It must always be borne in mind that the entire battery circuit is brought to the full*

*potential of the tube, and that it, therefore, has to be as thoroughly insulated both from the patient and the ground as has the tube itself.*

The full circuit is shown in Fig. 35, in which S is the parallel spark gap, M the milliammeter, B the storage battery, R the rheostat for controlling the current in the filament circuit, and A an ammeter for measuring this current. (A is not shown in the illustration. It is a convenience and not a necessity.) As the diagram shows, the resistance is all in, and hence the filament temperature is lowest when the rheostat handle is pushed as far as possible away from the operator.

If the polarity of the machine is wrong, it will be shown by the fact that the milliammeter will register no current, regardless of how high the filament temperature may be.

*The Battery.*—A convenient size is a 5 or 6 cell (10 or 12 volt) 40 ampere-hour battery, and it will be found much more satisfactory if arrangements are made so that the battery can be connected either every night

or else whenever not in use during the day, to the charging circuit. In some cases it will be found convenient to have the battery stand on the floor, while in others it may advantageously be placed higher up on a shelf.

In the latter case it will be necessary to re-locate the rheostat on the back of the stand, so that the handle will point in the right direction. Both the rheostat handle and the cord attached to the pull switch (in the battery circuit) should be brought through the lead screen which protects the operator, and to a point within easy and convenient reach.

Figure 34 shows the complete Coolidge X-ray equipment in position. The apparatus consists of a vertical stand supporting the X-ray tube and a separate battery unit on wheels. The battery unit is labeled with "RHEOSTAT HANDLE" and "PULL SWITCH". The stand has two terminals labeled "70 - TERMINAL".

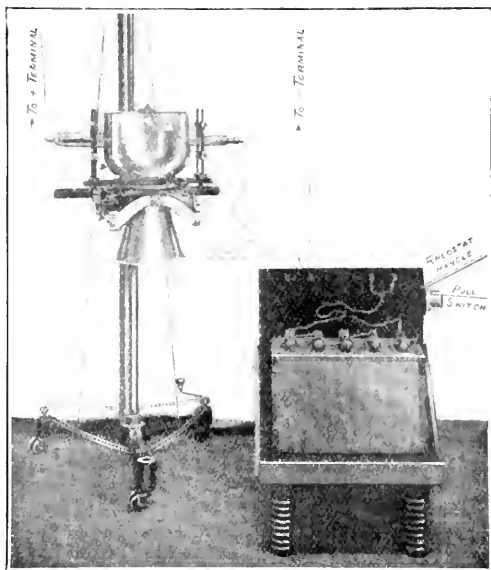

FIG. 34.—Complete Coolidge X-ray equipment in position. (B.T.H.)

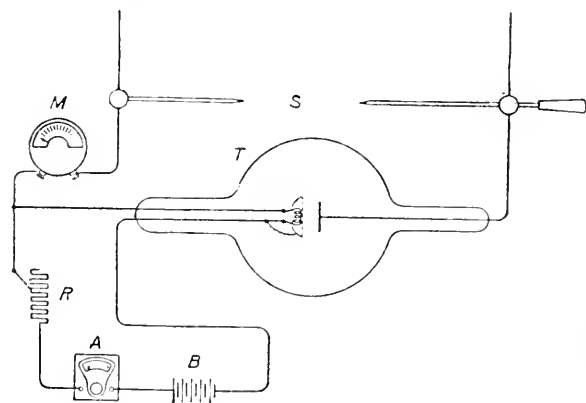

FIG. 35.—Diagram of connections for Coolidge tube.

Both the rheostat handle and the cord attached to the pull switch (in the battery circuit) should be brought through the lead screen which protects the operator, and to a point within easy and convenient reach.

*Method of Operating.*—The technique of various operators and the sources of excitation vary so much that it is difficult to make very detailed suggestions. The following general considerations, however, may be of value.

The higher the filament temperature, the greater the discharge current.

The higher the voltage backed up by the tube, the higher the penetration.

A simple method for starting radiographic work with the tube is as follows :

Take a case, for example, where the operator has been setting his rheostat on the 10th button, and adjusting his tube to where it then draws 30 milliamperes. In this case, all that is necessary, with the Coolidge tube, is to set the rheostat on the 10th button, light up the filament in the tube, having the handle pushed as far away as possible, close the main switch, and pull on the rheostat handle until the tube is drawing 30 milliamperes. The main switch is then opened, and the operator is ready to make his exposure.

In other cases, the radiographer will be accustomed to adjust the tube by means of the milliammeter and the parallel spark-gap. This procedure can be applied equally well to the Coolidge tube, and will naturally be the one first used in all cases where the operator is not familiar with his machine. Knowing that he wants, for example, 20 milliamperes and a 5-inch parallel-gap, he will start with the battery rheostat handle pushed well away from him, and with his main rheostat set on a low button. He will then pull on the battery rheostat handle, and run up to higher buttons on the main rheostat, until the tube is drawing 20 milliamperes and backing up the 5-inch gap.

The tube may be safely run with the target at white heat. If excessively high energy inputs are employed, the tungsten at the focal spot melts and volatilises. This results in a sudden lowering of the tube resistance and in blackening of the bulb. The instability in resistance disappears instantly upon lowering the energy input, and no harm has been done to the tube, that is, unless it is to be used for the production of the most penetrating rays which it is capable of emitting. In this case, a heavy metal deposit on the bulb is undesirable, as it interferes with smooth running at such high voltages.

The tube should not be run with voltages higher than that corresponding to a 10-inch spark-gap between points (that is, it should not be made to back up more than a 10-inch parallel-gap).

For long-continued running in an enclosed space and with heavy energy inputs, it will be necessary to provide some means of cooling the glass, as by a small fan or blower. The glass can, however, safely be allowed to get very hot. It is all right so long as it does not soften and draw in.

In running the tube on a coil, a valve tube should be used when heavy energy inputs are to be employed. So long, however, as the temperature of the focal spot is not made to approximate that of the cathode, the tube will satisfactorily rectify its own current.

There are tubes made in America which differ from the types usually

made on the Continent and in England, in that they are exhausted by a special process, and as no mercury is employed in the pumping it is impossible for mercury vapours to find their way into the tube ; this enables the tube to be exhausted "hard" in the first instance. The tube is hard from the beginning, and does not therefore require to be carefully worked up for radiographic or therapeutic work. It may be used at once for deep work. The tube may require to be regulated if it is too hard. These new tubes are fitted with a special form of cathode, which prevents the concentration of heat at the neck of the cathode. They are consequently not so liable to break down when overloaded.

The evolution of this type of tube in America is no doubt due to the fact that workers there are using more powerful apparatus for X-ray work, and have had to produce a tube which will stand up to the heavy currents generated by such apparatus.

**The Production of X-Rays.**—When a current of electricity from an induction coil is passed through an X-ray tube, a beam of cathode rays from the concave cathode is focussed on the target or anti-cathode, the surface of which is inclined at an angle of  $45^{\circ}$  to the rays. The anti-cathode is usually made of a metal of high atomic weight, such as platinum, tungsten, etc. The anode and cathode are usually of aluminium ; from the point of contact of the cathode stream on the anti-cathode, X-rays are given out in all directions. X-rays are invisible, and do not make glass fluorescent. The pale-green hemisphere of fluorescence on the bulb is due to reflected cathode rays from the anti-cathode striking the glass of the tube. This may be clearly shown by the action of a magnet on the boundary of the fluorescence. X-rays are not deflected by the proximity of a magnetic field. The pressure of the gas in an X-ray tube becomes lower with use, and a device for softening the tube (*i.e.* raising the pressure of the gas in the bulb) is therefore usually provided. The higher the pressure the less is the potential required to work the tube, and the less the penetration of the rays. The X-rays produced and the condition of the tube are termed "soft" if the pressure of gas in the bulb is high. The lower the pressure the harder are the rays. The cathode of the tube is made of aluminium, and is fixed just within the neck of a side tube to the bulb ; it is concave. As the exhaustion of the tube proceeds, the focus of the rays recedes farther and farther from the cathode, and may reach a distance of something like four or five times the radius of curvature of the cathode.

The relative positions of cathode and anti-cathode is a matter of experience with the maker. The anti-cathode is usually mounted a little out of focus to avoid its early destruction by fusion, the result of the extreme heat generated at the focus point. When sharp radiographic work has to be done the focus must be exceedingly sharp. Some makers turn out tubes with a very sharp focus, and excellent radiographs are obtained with such tubes. The drawback to the tubes is the comparatively short time they last.

*The Anti-cathode of the X-ray Tube.*—The requirements of an anti-cathode intended for modern radiographic work are :

- (1) A high atomic weight to secure a large quantity of rays.
- (2) A high melting point to permit sharp focussing.
- (3) A high thermal conductivity.

**Appearance of the X-Ray Tube in Action.**—When the X-ray tube is connected properly one-half of the tube between the cathode and anti-

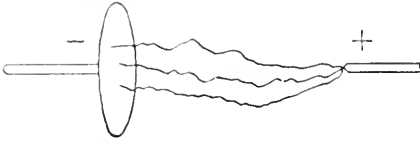

FIG. 36.—Connections of the X-ray tube to the coil, showing the route travelled by the spark when the point is the positive pole and the negative the plate.

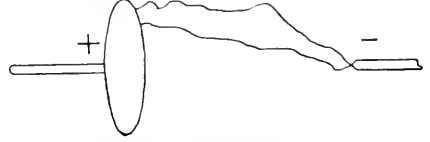

FIG. 37.—Connections of the X-ray tube to the coil, showing the appearance when the poles are reversed.

cathode looks as if it were evenly filled with green light, the other half of the tube behind the anti-cathode remaining dark, because the anti-cathode acts as a screen.

If wrongly connected there is an irregularly patchy fluorescence of the walls of the tube, and rays appear at intervals which change considerably according to the amount of current passing through the tubes.

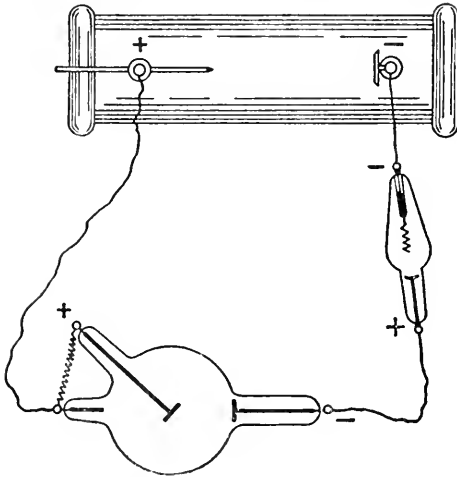

FIG. 38.—Connection of X-ray tube to the coil, showing coil and connections to tube. A valve tube is inserted on the negative pole.

For the appearance of the X-ray tube when correctly and incorrectly in operation, see the coloured frontispiece.

The important thing to remember is first of all to ascertain the polarity of the coil. This is done by testing with the spark-gap.

**Selection and Regulation of X-Ray Tubes.**—Little need be said on this point. As nearly all the tubes on the market are now good, the particular type selected

depends to a large extent upon the operator. When possible a number of good tubes should be kept in constant use. A tube which is in good condition and has a sharp focus should be reserved for radiographic work; for therapeutics a tube with a diffused focus is better than a sharp one because it will last longer. This requires to be taken with reserve. Some workers prefer to use a sharp focus for therapeutic work. It may be that the sharp focus of the cathode stream upon the anti-cathode may generate a beam of X-rays of particularly good therapeutic value.

Unless for special purposes it is always better to purchase tubes of a medium vacuum, inclining towards the soft side. A tube of large diameter,

7 or 8 inches, will continue to keep good vacuum longer than a smaller tube. For heavy currents, either in radiographic or therapeutic work, the larger tube will in the end be found most economical.

The chief advantage of having several tubes in use is that the very soft tube may be used for short exposures and gradually worked up for thicker parts. Then with about half a dozen tubes all parts of the body may be radiographed with a tube in proper condition for the part. New tubes are generally soft and require to be gradually worked up in hardness before they can be used for the deeper parts of the body. It is a good plan to reserve new tubes for short exposures of the thinner parts such as the hands, ankles, etc. After a few weeks of such work a new tube may then be used for the knees, shoulders, and elbows.

Later, when the tube has become seasoned, it can be used for the longer exposures required for radiography of the kidney areas, spine, and skull.

A new tube should never be overrun, that is, long exposure with large currents should not be used, because if they are, the vacuum may be hopelessly reduced, and the tube will then require to be re-exhausted. Once a tube is seasoned it will maintain its vacuum and degree of hardness for long periods, and may be used for hours daily. The amount of usage to be got from a tube which has been thoroughly seasoned is surprising.

Sometimes a tube after repeated short exposure may not harden. A good plan is to run such a tube for half an hour to one hour on the minimum current available. A  $\frac{1}{4}$  milliamperes through a tube for several runs of that duration may succeed in bringing it into a working condition. It should be treated carefully for several weeks.

The majority of tubes after prolonged use tend to harden. This natural hardening from use may be combated in several ways. The best of all is to regulate the tube by varying the intensity of the current passing through the bulb. A tube too hard for the object we desire to examine can be brought back to the proper degree by allowing a fairly strong current to pass for several minutes. If the current used is not sufficient for this purpose, pass a very heavy current for a moment.

A time comes with all tubes when we must use the mechanical regulator, the same remark applying to valve tubes. The form of regulator varies with the make of the tube, and all require some understanding before we can properly use them. In all cases it is better to begin reducing the tube with a minimum quantity of current and a fairly large interval of space between the cathode terminal and the regulating rod. The distance can easily be diminished, the important point being not to overdo the reduction.

When radiographing some parts of the body we estimate the degree of hardness of the tube by one of the methods enumerated, *i.e.* alternative spark-gap, Wehnelt radiometer, Benoist scale, and then place the regulating rod of the tube at the half distance of the spark-gap required, and allow current to pass through the tube. Sparking at once goes on between the two points, and some gas is liberated in the glass cylinder at the end of the regulator. The gas passes into the interior of the bulb, the shadow on the

screen is altered, and the sparking ceases. Make sure that the regulating rod is taken well away from the cathode before actually making the exposure, as a good tube may be hopelessly ruined if this simple precaution is not taken.

The various devices for regulation of the vacuum of a tube are illustrated on the tubes. The best of all, and one which gives the operator a perfect control over the tube when working, is the air valve of Bauer. This valve can be attached to any tube or valve, and is undoubtedly a great help to the operator. Dr. Loose of Bremen, who has used this regulator extensively, speaks very favourably of it, and indeed has abandoned all other forms in its favour. In using it, care should be taken not to introduce air too rapidly, and to introduce just sufficient to maintain the balance of the vacuum. One can readily judge of the action if the tube is observed carefully while reduction is going on.

The tube may, however, get too hard for regulation. It is then a good plan to transfer that tube to another apparatus of greater strength. A tube which has hardened on a mercury break may act perfectly if placed on an installation with an electrolytic break. The primary current is much greater in the latter case, the secondary is greater, and there is more heat generated in the tube, with the result that the vacuum tends to fall and the tube to soften. A hopelessly hard tube should be put away for several weeks in a warm corner of the X-ray room or placed in an oven for several hours. This may help to reduce it sufficiently to allow it to be used, and then by regulating the current carefully it may be possible to use it for some time.

When a tube has been used for a long time and gets too hard for work it is better to sacrifice it altogether. Re-exhaustion and remaking of the tube costs in many instances nearly as much as a new one, and these re-exhausted tubes are never so reliable as a new one. Consequently it is better to break up the tube, and have the valuable parts used for the construction of a new tube than to have it re-exhausted.

There are many other points in the management of the X-ray tube which must be learned as the result of experience. The fact must always be borne in mind that it is the tube which is the determining factor in radiography, and too great care cannot be taken of the X-ray tubes when in or out of use. Powerful currents if instantaneous do not harm the tube, but if prolonged the vacuum is lowered and the tube ruined. The quicker the exposure the more useful is the resulting radiograph likely to be. It should be noted that when a tube is used for all purposes, *i.e.* screening and radiography with heavy discharges, the balance of the tube is often seriously disturbed, regulation being then a matter of increasing difficulty. It is a good plan to keep one tube for screening and another for heavy work.

The effect of the most powerful impulse on the tube is hardly perceptible, a current of 100 milliamperes or more passing through a tube for the  $\frac{1}{100}$  of a second leaving hardly any trace on the anti-cathode. This current may



be employed on the cheapest form of tube without injuring it. There is, however, a tendency for a part or the whole of the current to arc round the tube if the vacuum is too high, consequently tubes with long stems or necks are necessary if hard ones are to be used. With these powerful impulses the soft tubes give the best results.

While for the taking of instantaneous pictures the most powerful installations are the best, it must be pointed out that quite good rapid radiographs can be produced by the use of installations of moderate power, provided the operator knows the apparatus he is using, and particularly if he possesses that knowledge of the X-ray tube which is, after all, the chief essential.

**The Manipulation of the X-ray Tube.**—The X-ray tube should whenever possible be placed at a distance of at least 6 or 7 feet from the source of energy (coil, etc.). If used within this distance there is a probability that the magnetic field may affect the cathodal stream, and thus alter the focus of the tube.

When the tube is supported by any form of clamp, the latter should grip the cathodal neck, below the level of the concave cathode, this being the strongest part, and should not clamp it too tightly. Before turning on the current, the tube should be carefully dusted, or dried if there is any moisture present.

The positive pole of the coil or other apparatus should be connected by well-insulated cables to the anti-cathode of the tube, and the negative pole to the cathode. It should be seen that all loose wires or metal fittings are quite clear of the tube.

The regulating wire should be placed well back from the cathode—say, at a distance of 6 or 7 inches. The point is emphasised in another portion of this work. There are exceptions to this rule in the manipulation of those tubes which work best with the regulator at a fixed distance from the cathode, according to the hardness of the particular tube and the purpose for which it is being used.

The current may now be switched on, starting with all resistance in, and gradually cutting this out until the tube fluoresces brightly and steadily. If the tube is inclined to spark over, bring the regulator to within a distance of 4 or 5 inches of the cathode, so as to provide a kind of safety-valve action. This will allow of the sparks passing between the regulator rod and the cathode, and tend to reduce the vacuum of the tube and so avoid the tube becoming punctured.

Before deciding that a tube needs regulation, allow it to run for a minute or two to give it an opportunity of finding its balance. Often it will be found

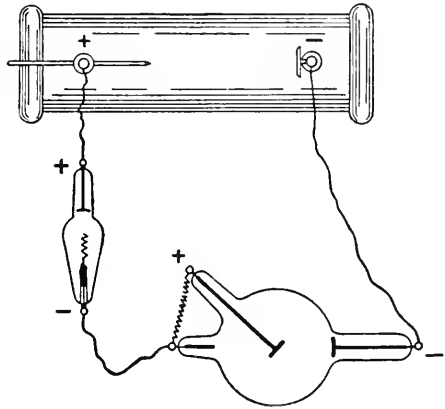

FIG. 39.—Connection of the X-ray tubes to coil. Valve tube on positive pole.

that a tube so treated will settle down after a short run. In other words, do not be in too great a hurry to regulate the tube. A little more or a little less current passing for a short time may successfully regulate the vacuum and allow of good work being done.

If regulation is necessary, proceed to adjust the regulating rod at a distance which will allow sparks to pass between the rod and the cathode until the tube works smoothly, and then remove the regulating rod away from the cathode and test the tube again.

Hardening the tube can only be satisfactorily done by gradually working a soft tube up through using it for very light work or for light treatment until it attains the necessary degree of hardness. Hardening by means of reversing the current is a method which should never be resorted to. When a tube becomes hopelessly soft, the only satisfactory thing to do is to have it re-exhausted.

When work is finished, if the tube is not kept permanently in position, it should be removed from its shield with great care, particularly while warm. If possible, it should then be placed upon a rack (which should be padded).

**Description of Methods used for Regeneration of the Vacuum of the X-Ray Tube.**—All tubes (excepting those of very simple construction), are fitted with a device for lowering at will the vacuum or internal resistance of the tube. The provision of this regulator materially increases the life of the tube. It should, however, be always borne in mind that regulation is to be regarded as the ultimate process, and not as an incidental to the working of the tube.

The number and variety of the regulators of X-ray tubes is a striking demonstration of the fact that the perfect regulator has yet to be introduced. Most of the present-day regulators are efficient up to a certain point. A few of the most commonly used will be described.

*The Mica Regulator.*—This consists of a small auxiliary chamber, in which is placed an electrode supporting a series of discs of mica. Facing the discs is a small metal knob which has no utility other than that of preventing a possible puncture of the tube, while regulation is taking place. Attached by a hinged cap to the mica electrode is a wire which may be brought into contact with the cathode terminal of the tube.

The method of lowering the vacuum of the tube is as follows: The jointed arm, E F, is moved (by means of a piece of wood, glass, or other non-conducting substance) towards B for a few seconds, whilst current is passing through the tube, when sparks should pass between F and B. The passage of the current between the latter two points (as shown by the sparking) results in the partial suspension of the current from its normal path; and during the flow of the current through the electrode in the auxiliary tube, a small quantity of gas is liberated, with the consequence that a reduction in the vacuum takes place. When this has been achieved the sparking will automatically cease, the resistance of the tube itself having become less than that of the gap F B. The wire F should

now be thrown well back, and the tube run cautiously for the first few minutes after regulation.

The regulation of the tube during use may be made automatic, if desired, by placing the wire F at such a distance from B that sparking (with consequent regulation) takes place whenever a certain degree of vacuum is attained. This distance may easily be determined by experiment with the individual tube in use.

In the case of a tube which fails to regulate by the above method, it is permissible to remove the lead from the cathode and attach it to the loop E. The current should now be passed with extreme caution, the pressure being very carefully increased until the gas is expelled from the mica.

In order to appreciate the degree to which regulation is taking place, the mica disc should be carefully watched while the shunt circuit is established. It will be seen that the mica shows little flecks of red here and there, and when these appear, it is a sign that gas is being expelled. The time during which

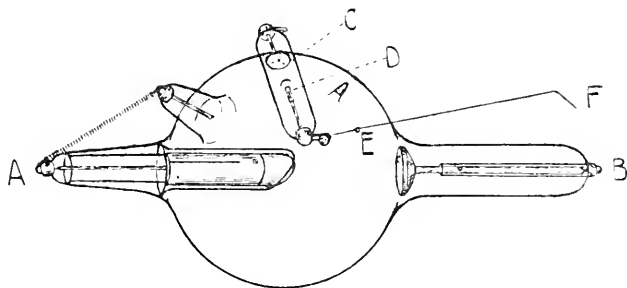

FIG. 40.—Mica regulator. (C. Andrews.)

A, Anti-cathode.	C, Mica disc.	E } Wire.
B, Cathode.	D, Carbon.	F }

the current should be passed through the regulator depends obviously upon the degree of hardness of the tube, and the amount of softening which it is desired to attain; but in any case it is wiser to switch off the current as soon as the fiery appearance is seen in the mica, swing back the regulator wire, and test the tube; and then to repeat the process of regulation if necessary.

The regulator shown is merely a variation of the standard mica pattern, and is fitted to some smaller tubes on account of its greater convenience where a 125-mm. bulb is employed. The mechanism is the same, but in place of the hinged wire, a shaped wire is fitted on a spring and pin bearing. Normally this wire rests in the position illustrated. To effect the softening, the wire is tilted with a piece of glass or wood until F B are in contact, when the effusion of gas from the mica takes place.

Larger models are fitted usually with a *double* regulator, namely carbon and mica.

This consists of a chamber exactly similar to that described above, excepting that, in place of the small metal knob, there is fitted an electrode carrying a cylinder of carbon. This is capable of giving off gas in exactly

the same way as does the mica disc ; and so, in this double regulator, one has two supplies of gas upon which to draw. By means of a thumbscrew the regulator wire can be changed from one side of the regulator to the other, so that when one source of gas is exhausted, the second may be brought into use. The carbon regulator is operated in the same way as the mica, but it should be noted that there is no "fiery" appearance with the former, and also that the carbon works rather more freely than the mica. Care should therefore be exercised in order to avoid over-regulation.

In the ordinary way, a current of 1 or  $1\frac{1}{2}$  milliamperes will cause the standard regulator to work in a few seconds, but in some cases, and especially when the regulator has been much used, a greater current may be necessary in order to heat the carbon or mica sufficiently. Experience will demonstrate this. The gases which are supplied by it to the tube allow the latter to remain constant and steady.

The regenerating arrangement with which some tubes are provided, is constructed on the principle of osmosis. The metals of the platinum group, especially palladium, have the peculiarity that they allow hydrogen to pass while incandescent. A tube of palladium, closed at one end and open at the other, is sealed into the neck of the tube. To protect it against accidental damage it is covered with a test tube, which can be taken off. When the tube has become too hard, remove the test tube and apply a spirit flame for a few seconds to the palladium tube till it is dark red. The hydrogen contained in the spirit flame penetrates into the inside of the tube, and makes the tube softer. The flame must not be brought near the point where the metal is sealed with the glass.

After the tube has been regenerated time should be allowed for complete cooling before it is used again. It is advisable to bring the tube to the desired degree of softness each time before it is used, and only to heat the extreme end of the palladium tube.

*The Bauer Air-Valve Regulator.*—Another form of regulator is the

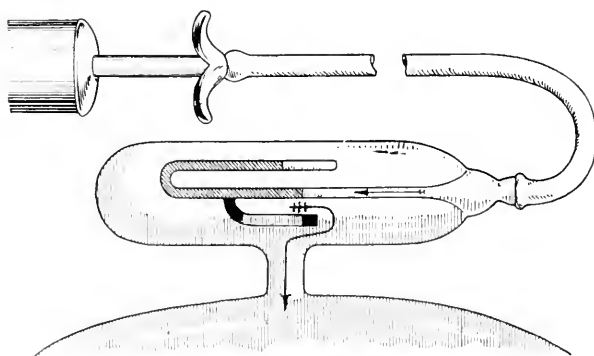

FIG. 41.—Bauer air-valve. (Favre.)

air-valve invented by Mr. Heinz Bauer. This consists of a delicately-constructed valve, closed by a column of mercury, and fitted with an air

filter. By means of a small hand pump and an india-rubber tube, the column of mercury is depressed so as to open a very small aperture, through which a minute quantity of air is thus allowed to pass. The mercury rises almost immediately, and the opening is again sealed, the vacuum of the tube having meanwhile been lowered by the admission of the air. If desired, the Bauer valve may be worked with a long rubber tube, thus allowing of regulation taking place from a distance, and while the tube is actually running.

*Gundelach Regulator.*—Another very good regeneration apparatus may be described.

This arrangement consists of a little condenser which is made in the form of a cylindrical glass tube covered with an imperfect conductor of electricity. By special treatment this conductor is made to absorb a large quantity of gas. It is then covered with a second glass tube, and both cylindrical glass tubes are so treated that they cannot be pierced by a spark.

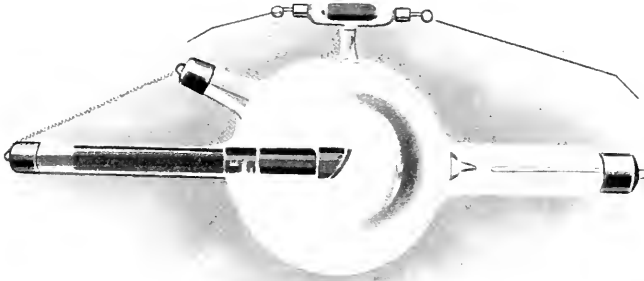

FIG. 42.—Gundelach tube with regenerator. (Siemens.)  
*a*, wire.      *b*, wire.      *c*, metal cap.      *d*, metal cap.

When the tube has become too hard, put the wire *b* of the regenerating arrangement in contact with the metal cap *d* of the tube. The other wire *a* has to be so far from the metal cap *c* that a shunt-spark passes. This shunt-spark should be half as long as the equivalent spark of the Röntgen tube after regeneration, because the resistance of this regenerating arrangement is considerable. The current produces some gas from the substance of the regenerating arrangement, and after a few minutes the tube will again fluoresce regularly. The regeneration, however, is only completed when the shunt-sparks have ceased to pass. After regeneration turn back both wires. This new regulator will work easily even when the resistance of the tube has become so great that no electric current will pass through the Röntgen tube.

This arrangement has the great advantage that owing to the two conductors being separated by a glass tube, the gas is set free uniformly from

all parts of the conductors, and the whole of the gas contained therein, which is considerable, can be utilised.

In order to obtain good pictures it is generally necessary to regulate the hardness of a tube each time previous to using it, and the tube should be adjusted for a medium hardness; and this should be done by means of the regenerator.

### Suppression of Reverse (Inverse) Current

The reverse current is obviously a great inconvenience and must be got rid of if good negatives are to be obtained. It is possible to keep it down to a minimum by using a low voltage, a high self-induction, and a low frequency in the primary coil, but if intense discharges are required we cannot suppress it entirely in this way, and other means must be adopted.

Valve tubes or spark-gaps are frequently connected in series with the X-ray tubes.

In a **Spark-gap** the current can discharge easily between a point and a plate if the point is the positive pole, but it does not do so if the point is the negative pole. It is possible, then, to create an impediment or resistance

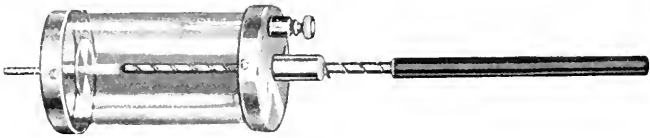

FIG. 43.—Spark-gap. (Siemens.)

to the current in one direction only, whereas the passage is left free in the other.

There are many types of **Valve tubes**, the most commonly used being the single valve tube, but the triple valve tube is also used.

The nature of reverse current has already been explained. In all coil outfits this has to be checked. It is possible by a careful adjustment of primary current, interrupter, and tube, to cut this down to a minimum, but the slightest disturbance of these factors gives rise at once to a percentage of inverse current, which, if allowed to remain, has a deleterious effect upon the tube and tends to harden it. Should it become very hard the persistence of inverse current with strong currents in the primary leads to damage of the tube; sparking takes place, and the tube is punctured.

It is generally appreciated that the current which is utilised in the production of X-rays is that which is passing when the current is breaking, *e.g.* when the magnetic field is at the point of collapse, and it is the endeavour to obtain a maximum tension at the moment, and to relieve or “break” such tension with sufficient speed and completeness, that gives rise to the constant alterations and improvements—real or fancied—in modern medical electrical apparatus. The more complete the saturation of the induction

coil, and the more suddenly the saturation can be "vented," as it were, through the secondary circuit, the more efficient (other factors being equal) the phenomenon of the Röntgen rays produced.

On the other hand, the current which is passing when the current is "making," *e.g.* when the cycle of the magnetic field is first commencing in the primary of the coil, is flowing in a reverse sense to that of the current at "break": and it can therefore be seen that if this current is allowed to flow through the X-ray tube, it cancels, as it were, a portion of the "breaking" pressure equal to its own. Now, the result of this is not only a loss of efficiency in that it is a loss of working current. The effects are, unfortunately, more far reaching than that, the X-ray tube becoming irretrievably damaged. In the first place, the actual passage of current in the "reverse" direction through the tube means that the anti-cathode, or positive pole of the tube, becomes, for an instant, cathode, and *vice versa*. Now, it is an established fact that the cathode electrode breaks up much more freely and quickly than the anti-cathode, and for this reason the cathode is always made from aluminium, which is less destructible in this sense than any other metal. But if the current is reversed, and the "cathode" is, for the moment, the copper "anti-cathode," the destruction is much more rapid, and particles of metal are torn off from the surface.

The fragments of copper, tungsten, etc., thus detached are projected with enormous rapidity towards the wall of the tube, to which they adhere, forming a thin metallic coating, particularly on the back zone of the bulb (*e.g.* behind and above the plane of the surface of the target). The result of this coating of metal is to absorb all the free gas in the tube, and is the explanation of an old blackened tube remaining often dead hard, however much it may be regulated or re-exhausted. The blackening described above must not be confused with the violet coloration *in front* of the plane of the target, which latter is a normal condition in all tubes after use, and which is free from objection.

The second ill-effect is that of overheating. If the usual form of milliamperemeter, known as the "moving coil" type, be employed, its reading is that of the difference between the "correct" and "reverse" currents. For example, supposing the current in the right direction to be equal to 2 milliamperes, and that in the wrong or reverse direction to be equal to 1 milliampere, the milliamperemeter would indicate 1 milliampere. But although this would be accurate so far as the measuring of the current itself went, it must be remembered that the *heating* effect of an electrical current increases as the square of the amperage. So that, although the operator may say, "The tube is all right; it is taking only 1 milliampere," we are subjecting it to the strain of 3 milliamperes so far as heat is concerned, *e.g. nine times* the heat of a real 1 milliampere current. As has already been pointed out, it is mainly the heat which destroys the balance of the vacuum of the X-ray tube.

It is admittedly a very difficult matter to construct a modern installation which shall be free from reverse current, particularly as with the higher

amperage which is demanded for rapid work, high voltages must also be employed, and the greater the voltage the greater the reverse discharge. The only means, therefore, of combating the evil is to introduce some device which shall "rectify" the discharge, *e.g.* eliminate the reverse current while interfering with the proper current as little as possible.

In order to effect this, many contrivances have been tried, notably a simple "spark-gap" and various forms of mechanical rectifiers. The most usual and most efficient method is, however, the valve tube, a vacuum tube which permits the current to pass unobstructed in the right direction but which should suppress absolutely the reverse or making current.

*Single Valve Tube.*—This valve tube, owing to its special construction, is much less inclined to become hard than the simpler types of valve tubes. It is, however, fitted with the new regenerator so that it can be maintained at a uniform degree of softness; this should be maintained at about 16 mm. equivalent spark-gap. When the tube requires regenerating one wire should be connected to the anode cap (positive), and the other held at a distance of about 5 mm. from the cathode cap (negative). As soon as the tube shows a white foggy light the regeneration is finished.

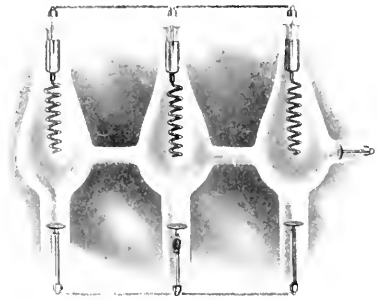
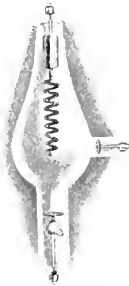

FIG. 44.—Single valve tube. (C. Andrews.)

FIG. 45.—Triple valve tube. (C. Andrews.)

Formerly when it was desired to rectify on higher voltages, or while using heavy currents, two or more valves were placed in series; but a difficulty then arose by reason of the fact that such valves did not always increase in hardness to the same degree, and it was therefore almost impossible to maintain an efficient rectification, and, at the same time, to pass the full amount of current needed. In order to overcome this trouble a "double" valve was designed, consisting of two bulbs and sets of electrodes, each exactly similar to one single valve, but joined together in such a manner that one vacuum is common to both chambers. The latter are then connected in parallel, and placed in series with the X-ray tube, the result being that the backward resistance is doubled, the current flowing between the two sets of electrodes. With such a double valve, complete rectification on voltages up to, say, 200 is obtainable.

*The Triple Valve* is constructed similarly to the foregoing, but has three



intercommunicating chambers, and is intended for use on the highest voltages and for the heaviest discharges.

Valve tubes may be had either of clear glass, of blue, or of a deep amber colour. The latter is preferred by many workers, as the colouring serves to disguise the fluorescence, and thus permits of a better judgment of the condition of the Röntgen tube itself.

*High-tension Rectifier.*—A different form of valve is that known as the high-tension rectifier. It consists of a long aluminium funnel and a curved mirror, the bulb being spherical, and of a diameter of approximately 18 cm. This form of valve is very efficient, even on high voltages, but it has a tendency to increase in vacuum somewhat rapidly. For this latter reason an osmosis regulator is provided, so that regulation is possible as often as desired.

*French Type.*—Yet another form is that known as the “French type,” which is very similar to the single valve. It has, however, in place of the plate anode, a thin pin with a slightly flattened head, and the neck of the



FIG. 46.—French valve. (C. Andrews.)

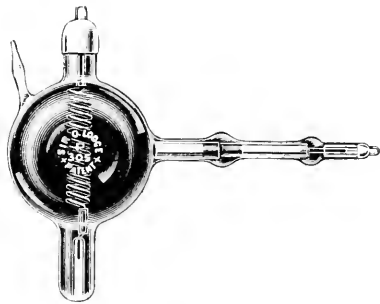

FIG. 47.—Oliver Lodge valve tube. (Cossar.)

tube surrounding this is of much smaller diameter than in the other cases. The action of this valve is very perfect, complete rectification being obtained without any appreciable loss of current. The French pattern is, however, rather more delicate than the others, and also tends to go up in vacuum rather quickly. The provision of an osmosis regulator permits, however, of the latter trouble being overcome.

*The Oliver Lodge valve tube* is often used. It has the disadvantage that it cannot be regulated, but it is claimed for it that it does not require regulation. This claim is open to question. When it is necessary to check the reverse current which is found when very heavy discharges pass through a tube a number of these valve tubes may be placed in the circuit.

**Regulation of the Valve Tubes.**—The regulation of valve tubes is effected in a similar way to that of X-ray tubes, according to the type of regulator in use. In the case of the mica or carbon patterns, the lead which is normally attached to the plate (anode), should be attached to the ring of the regulator, and current passed until the blue appearance has been restored to the valve tube. The lead must then be reconnected to the anode terminal.

Valve tubes should never be worked "hard." An intermediate vacuum, giving a Geissler discharge in the body of the tube, with a slight apple-green tint round the spiral base, will be found best. Do not forget also, that a "hard" valve tube may be emitting an appreciable quantity of Röntgen rays, with a consequent need of protection for the operator.

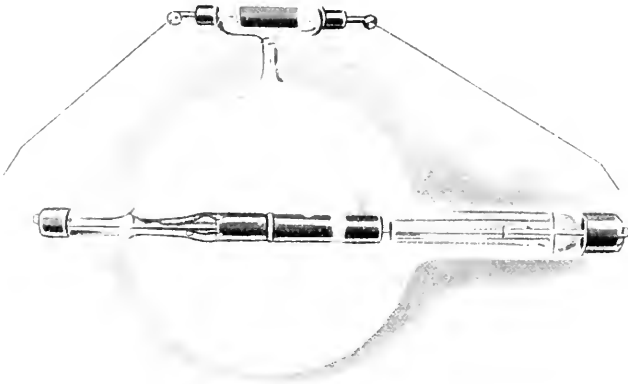

FIG. 48.—Gündelach valve tube. (Siemens.)

*Bauer Air-valve.*—The latest improvement in the valve tube is the introduction of a Bauer air-valve for the regulation of the vacuum. This is very useful and easily handled by the use of a small hand-pump, a long rubber tube allowing of regulation from a distance.

When intensive currents are used it may be necessary to put a valve tube on each pole or even to have 6 or 8 valve tubes in series. By using valve tubes the amount of inverse current can be practically abolished when medium currents are employed, but when very heavy currents are used it is not possible, or hardly ever possible, to abolish it.

There are several other varieties of valve tube of more recent construction. The various types described are useful on installations of medium power, but if they are used on the more powerful installations of recent date, they soon begin to vary in hardness, and add considerably to the difficulties of the radiographer. This is particularly noticeable when the installation is used alternately for short exposures and long ones. The balance of the valve tube is disturbed, and it will require almost constant regulation. It should be pointed out that when valve tubes are used they require nearly as much regulation as the X-ray tube. When the X-ray tube is known to be right and the results are not satisfactory, attention should be paid to the condition of the valve tube. Of the more recent type of valve tubes the most efficient is one manufactured by the Polyphos Company.

Valve tubes from America are promised which should be a great improvement on the ones at present in use in this country.

**Method of Detecting Reverse (Inverse) Current.**—A good guide to the presence of reverse current is the appearance of the tube in action, rings then appearing on the aspect of the tube behind the anti-cathode, and the green light in front not being so clearly cut as when there is no trace of reverse current. See frontispiece.

The continued presence of reverse current leads to changes in the condition of the tube. It gradually hardens, and the change in its state may show itself in a variation in the sounds produced when in action.

The best method of detecting reverse current is by the use of an oscilloscope tube. The construction of such a tube is worthy of description. Two aluminium wires, separated by a small gap, are enclosed in an oblong glass



FIG. 49.—Oscilloscope tube. (Siemens.)

tube, and the wire connected with the negative pole becomes, when the current passes, surrounded by a violet fluorescence. If the current discharges in one direction, only one of these wires shows the violet light, but if each wire is alternately negative and positive both wires become fluorescent and the length of the fluorescent band indicates the intensity of the current, so that we can compare the relative strength of the closing and breaking currents.

There are several varieties of tube but the diagram illustrates the general type in use.

The instrument is useful. It records the current passing in one direction through the tube. If reverse current is present it represents the difference between the two currents. When both are equal then no reading is recorded. If the reverse is greater than the current in the right direction, then it records on the wrong side of the zero mark. When the oscilloscope tube shows that reverse current is present, then valve tubes must be used to check the reverse. The combination of milliamperemeter, valve, and oscilloscope tubes is a most useful one, helping greatly to regulate the exposures.

The X-ray tube affords an excellent indication of the presence of reverse current. The change in the appearance of the tube which has reverse current passing through it is illustrated in the coloured frontispiece.

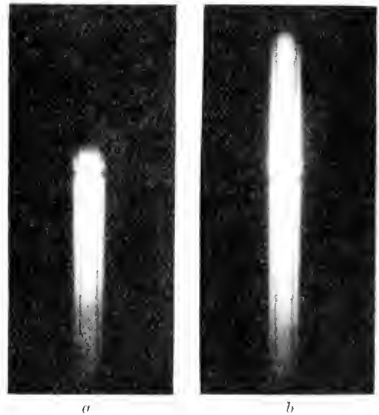

FIG. 50.—Oscilloscope tube in action. (Schall.)

- a*, The appearance of a tube with the current passing in the right direction with a trace of reverse current.  
*b*, The appearance with the current passing in both directions in almost equal proportions.

**Secondary Radiations, Cause, and Methods of Suppression.**—

*Secondary rays* are produced by the reverse current. All those X-rays which do not emanate from the focus of the anti-cathode are called secondary rays. They have the same penetrating power as the primary rays and are plentiful in hard tubes, but they project the outlines of the objects in other directions than the primary rays, and a loss of sharpness results.

When they are present it is necessary to do something to prevent deterioration of the negative. Secondary rays are also produced, or a diffusion of the primary rays takes place in the patient's body. It is probable

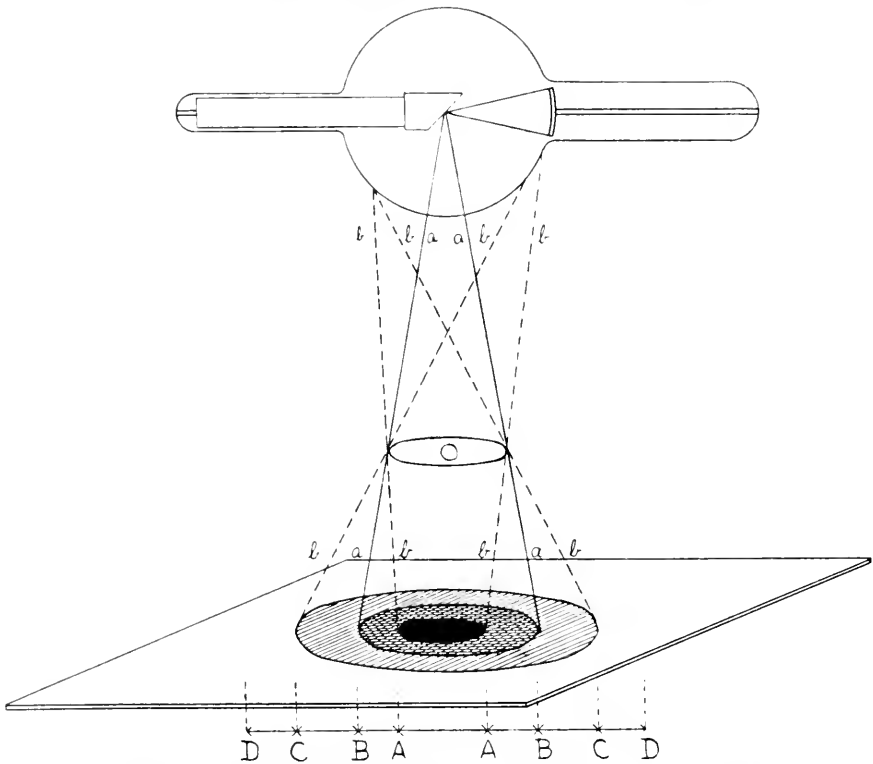

FIG. 51.—Diagrams showing the paths taken by primary beams and secondary rays. (Schall.)

that both of these manifest themselves during a long exposure. Fig. 51 shows the path taken by the primary beam, and the manner of projection of secondary rays upon the photographic plate.

The X-rays, A A, emanating from the focus of the anti-cathode project a shadow, B B, of the object, O, on the plate. If there were no secondary rays this shadow would be of uniform darkness from B to B, and the space, B C D, would be free from any shadow. But if any current discharges in the wrong direction, the so-called secondary rays are generated on the glass of the tube. They are indicated by the dotted lines *b b*. Although weaker in intensity, they project shadows, and in another direction than the primary rays will do; the shadows overlap, and the part between A B will not be so

dark as that between A A and the space between B C will not be as clear as that between C D. The effect of the secondary rays is therefore to make the outlines less sharp, and to cause a general fogginess. In consequence of this some details will become indistinct and the finer ones will disappear entirely.

In order to minimise the effect of the secondary rays produced by reverse currents upon the plate, diaphragms are used. A diaphragm alone is not sufficient, and an extension tube should also be combined with the diaphragm.

The following illustration shows this method of checking these ill-effects to some extent.

The illustration (Fig. 52) shows the primary or principal rays *a a* emanating from the anti-cathode A; the dotted lines *b b* indicate secondary

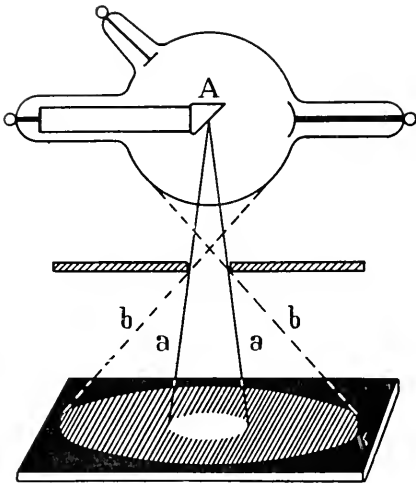

FIG. 52.—Diagram showing the use of a diaphragm between tube and plate. (Schall.)

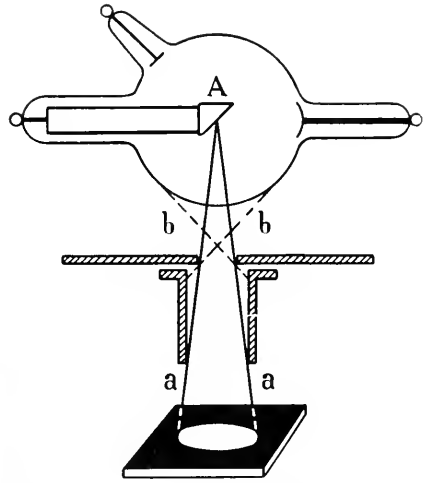

FIG. 53.—Diagram showing the use of a cylinder diaphragm. (Schall.)

rays emanating from the glass wall of the tube. If we place a diaphragm between tube and plate, some of these secondary rays are stopped, and, the nearer the diaphragm to the tube, and the narrower its aperture, the more efficient will it be. But as metal plates cannot be brought quite close to the tube, some secondary rays will still reach the plate unless a *cylinder diaphragm* is employed. Fig. 53 shows why a cylinder diaphragm is bound to exclude more secondary rays than a flat diaphragm can do; the cylinder diaphragm can also be used with advantage for compression.

## Instruments for Estimating the Hardness of the X-Ray Tube.

The X-ray bulb in action presents a picture which in itself is a guide to the condition of the tubes as regards hardness, presence of inverse current, and radiographic value, but if good work is to be maintained it is necessary

to be able to record the actual conditions under which a particular standard has been attained. When this has been done it should be possible to reproduce the condition of tube necessary at any time.

There are several methods for estimating the degree of vacuum (or hardness) of the X-ray tube. These are (a) measurement of the alternate spark-gap, (b) the Bauer Qualimeter, (c) radiometers: (1) Walter, (2) Walter-Benoist, (3) Wehnelt cryptoradiometer, (4) measurement by the milliamperemeter.

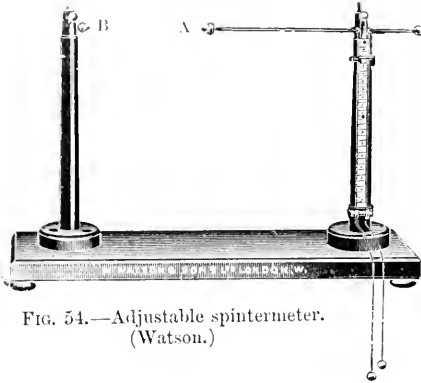

FIG. 54.—Adjustable spintermeter. (Watson.)

A rough though practical method of estimating the internal resistance of the X-ray bulb consists of the **Spintermeter**, by means of which the alternate spark-gap is measured. A convenient form of spintermeter is here shown. The action is simple. The point A is withdrawn to its limit, and the tube set in action. By gradually approximating the point A to the point B a position is reached when the current, instead of passing through the tube sparks between the points A and B, a scale attached giving the distance in inches or centimetres. The spark-gap is measured, and gives approximately the hardness of the X-ray bulb. The spintermeter may be attached to the coil, or more conveniently mounted on a separate base, and placed at some distance from the coil.

The **Bauer Qualimeter** is an instrument for determining the degree of hardness of the X-ray tube. It is useful, but not always to be relied upon.

This instrument is connected by a wire to the negative terminal of the coil or the cathode of the tube. It is a static electrometer and condenser which indicates automatically the potential of the cathode, and hence the quality of the X-rays. The apparatus consists of two wings, which swing between two fixed plates. Both wings and plates are equally charged, so that a repulsion takes place between them. The intensity of this repulsion is in exact proportion to the electrical tension in the secondary circuit, and is indicated by the deviation of a pointer over a suitably divided scale.



FIG. 55.—Bauer qualimeter. (Favre.)

As is well known, the penetration of the X-rays is a function of the

electrical potential in the secondary circuit, so that a simple measurement of this potential between the anode and cathode will give us an indication of the hardness of the tube. The scale is gauged according to the absorption of the X-rays by sheets of lead of different thickness, increasing regular from one-tenth of a millimetre to one millimetre.

No. 1 on the scale denotes X-rays of such a hardness as to be totally absorbed by  $\frac{1}{10}$  millimetre of lead. When the index is at No. 10 we know that the tube is giving out rays which will penetrate 0.9 millimetre of lead, but will be totally absorbed by 1 millimetre of lead.

As already explained, the instrument is unipolar, being joined up by a single wire to some point in electrical connection with the cathode. The instrument is contained in an ebonite case, which swings freely from a bracket on the wall or a stand, so as to be always in a vertical position.

The following experiment will demonstrate the use of the instrument. The tube is disconnected, and a current from the generator is sent through the spark-gap. In this case the deflection of the qualimeter becomes greater with the increasing spark-gap, while the reading of the milliamperemeter recedes. The spark-gap itself is often used for gauging the hardness of the tube. This proceeding, however, is not exact enough for practical purposes, as the resistance of the spark-gap is dependent upon the form of the electrode ball, point, or disc, and upon the humidity of the atmosphere.

No metallic surface should be allowed to be within a distance of 8 to 10 inches from the instrument. The purposes for which the qualimeter can be used are the following :

*Therapeutics.*—It is becoming more and more imperative to regulate the hardness of the tubes to the various diseases treated. As modern publications almost always give the degree of hardness in qualimeter degrees, it is obviously necessary to employ the qualimeter to obtain the same results. The spark-gap, which has very generally been used up till now, is to be rejected for the reasons mentioned above. In addition to this it is possible by the help of the qualimeter, to use the so-called indirect calculation of the erythema dose instead of the direct measurement by the Sabouraud pastille, in cases where the degree of hardness employed is always approximately invariable, as is the case in the treatment of the skin and deeper tissues.

The process can be shortly described as follows : Take a new X-ray bulb and give an erythema dose, noting the reading of the milliamperemeter and the qualimeter and the time. The product of these three factors—time, milliamperemeter, and qualimeter degrees—will be always found the same for the erythema dose (under an approximately unvarying degree of hardness), however much the two other factors—intensity and time—may be varied. This method has been scientifically proved by Klingelfuss of Basel. A practical example will serve to illustrate the above. If an erythema dose has been reached in ten minutes with a hardness of 3 Bauer-degrees and an intensity of 4 milliamperes, the product will be  $10 \times 3 \times 4 = 120$ . If a bulb is being employed which registers 3 degrees of hardness with an intensity of

2 milliamperes, it will take twenty minutes to produce the same result: the product will again be  $2 \times 3 \times 20 = 120$ . For treatment of the skin and deeper tissues, two different degrees of hardness are generally used (for example, 3 Bauer and 7 Bauer), and the erythema dose need only be calculative once for all. Slight fluctuations in hardness make no difference, and if they occur during exposure they can be adjusted by regulating the primary current. On the other hand, the current employed must be kept within such bounds that the tube remains steady. Should the current through the tube be too strong or too weak, more or less current may be passed through the tube by adjusting the shunt. Too weak a current hardens the tube, whereas too strong a current has the opposite effect.

For comparative scale of the usual instruments for measuring the hardness of tubes, see page 61.

*Technique for Exposures.*—The time of exposure can be calculated in the same way as that for an erythema dose. We first ascertain within what time and with what degree of hardness and intensity a good Röntgen negative of any particular region is obtained. These readings may be noted on a chart hung within the protective cabin, and in this way, by using the same figures, a satisfactory result can always be obtained, and failures excluded. It is here that the qualimeter is particularly useful, since different degrees of hardness are required for the production of good pictures of various parts of the body. If the operator prefers to use one tube for all purposes, he will find the Bauer air-valve tube most practical. With this he is able to adjust the tube to any degree of hardness desired. For instantaneous exposures the most important point is to adjust the hardness of the tube so that a sufficient number of hard rays may be emitted. To ascertain this, the tube should be driven with a normal intensity of 2 milliamperes, and the hardness tested by the qualimeter. From the resulting negative it can be immediately ascertained whether the tube is too high or too low. If the picture is too faintly shaded, the degree of hardness was too low; if it is too dark, the degree was too high.

As the result of considerable experience in the use of this instrument it may be stated that the qualimeter is particularly suited for radioscopic work, since it indicates the hardness of the tube at a distance, and without the operator being brought into dangerous proximity to the tube in order to measure its hardness.

As has been said, the qualimeter has not only created a possibility of working with greater exactness, but—and to this we again call particular attention—it is not now necessary to come within the dangerous area for the purpose of ascertaining the degree of hardness. Finally, with its help the tubes can be worked much more economically.

**Radiometers.**—These serve to determine accurately the degree of hardness of the tubes, that is to say, the penetrability of the rays.

*Waller's Radiometer* consists of a sheet of lead mounted on a wooden frame and with eight circular holes, combined with an adjustable fluorescent screen. The holes are covered with platinum foil of a thickness varying in



geometrical progression from .005 mm. for hole No. 1 to .64 mm. for hole No. 8. If the apparatus is placed in the path of the rays a certain number of holes become visible on the fluorescent screen, the number depending on the hardness of the tube. The degree of hardness is indicated by the largest cypher marked on the visible holes.

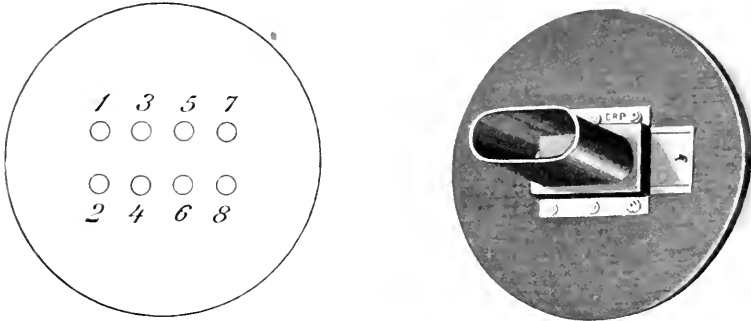

FIG. 56.—Walter's radiometer. (Siemens.)

The *Walter-Benoist Radiometer* has aluminium apertures of various thicknesses and a piece of silver foil. One of the aluminium apertures will show the same degree of brightness as the silver foil. The cypher on this aperture indicates the hardness of the tube.

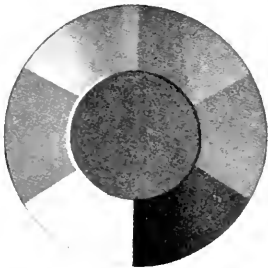

FIG. 57.—Benoist radiometer. (Siemens.)



FIG. 58.—Protected front for Fig. 57.

A simple form of Benoist radiometer, with slots for screws, may be fixed on the fluorescent screen; the lead glass covering the latter protects the operator.

*Wehnelt's Crypto-Radiometer* is an improvement on the foregoing radiometers. It is provided with a wedge-shaped aluminium strip, and alongside this a flat silver strip, both of which can be moved by means of a ratchet over a brass plate provided with a thin slit. The apparatus is adjusted until both strips show the same degree of brightness on a fluorescent screen. A scale indicates the position of the aluminium strip, *i.e.* the penetration of the tube.

This is a useful instrument; it is efficiently protected, and will be

found to be extremely useful for routine work. The radiometer can be fitted behind the lead-lined screen, and a suitable tube-holder attached to the tube while it is being tested. A slit must be cut in the lead linings of the screen. Then the apparatus may be used with safety.

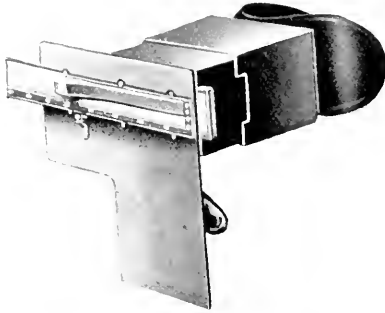

FIG. 59.—Wehnelt's crypto-radiometer.  
(Siemens.)

When using these radiometers, and particularly at the present time when heavy currents and hard tubes are coming into general use, it is necessary to point out that the protective devices supplied with the measuring apparatus are not nearly sufficient for the protection of the operator if many observations have to be made daily. The instruments should be mounted on a screen lined with thick lead, and the slots for comparing standards should have thick lead glass.

The instruments described all estimate more or less accurately the hardness of the X-ray bulb. There are also instruments which measure the quantity of current actually passing to the tube. These are useful in estimating the exposure necessary at particular times. Later, the exact method of combining all the factors required for the estimation of exposure will be described. For our present general purpose it is sufficient to state that there are instruments used to measure the current passing through the tube, the actual quantity of which will vary with the internal resistance of the tube. For example, a soft tube will allow, say, 10 milliamperes to pass, whilst with the same primary current a much harder tube will only allow, say, 1 milliampere to pass.

**Measurement of X-Rays by Milliampere-meter.**—A milliampere-meter is necessary for this purpose when radiographic exposures are given, and acts by estimating the quantity of current passing through the X-ray tube. That shown is a Deprez-d'Arsonval moving coil instrument, and it is an advantage to have the zero in the centre of the scale for measuring positive and negative currents. They do not show the actual current traversing the X-ray tubes, but its mean value, which can, however, be taken as a relative measure of the intensity of the rays. So long as the pointer remains stationary this indicates that the hardness of the tube is constant. Should the tube, when in use, become harder, the pointer will move towards zero. The instrument is as a rule specially constructed so that it is impossible for sparking to occur inside, and the pointer should be well damped. There are other instruments for

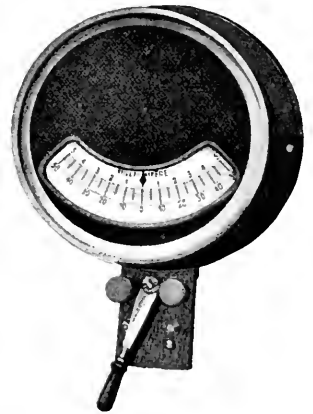

FIG. 60.—Milliampere-meter.  
(Siemens.)

measuring the quantity of X-rays used in dosage. These are described more fully in the section on Radio-therapeutics.

The table below gives the comparative values of the instruments most frequently used, namely : Bauer, Wehnelt, Walter, and Benoist.

COMPARATIVE SCALE OF THE USUAL INSTRUMENTS FOR MEASURING THE HARDNESS OF TUBES

	soft				medium				hard	
Bauer . . . . .	1	2	3	4	5	6	7	8	9	10
Wehnelt . . . . .	1.5	3	4.5	6	7.5	9	10.5	12	13.5	15
Walter . . . . .	1	1.2	2.3	3.4	4.5	5.6	6.7	7.8		
Benoist . . . . .	1	2	3	4	5	6	7	8	9	10

The ingenious method used for the control of the Coolidge tube appears to be the perfect one for the estimation and control of the hardness of the X-ray given off from the bulb.

The penetrating power of the X-rays is dependent upon the speed of the cathode stream, and the latter is varied by increasing or diminishing the potential at the terminals of the tube. The provision of an ammeter in the battery circuit gives the means necessary for estimating the hardness of the ray. The milliamperemeter in the secondary circuit gives the current passing through the secondary circuit. By using these two indicators together it is possible not only to estimate but to produce at will a particular and fairly constant type of X-ray. This not only dispenses with other more tedious methods of estimation but enables the operator to reproduce at any time the particular ray he may require.

## TUBE STANDS, COUCHES, COMPRESSORS, AND SCREENING STANDS

### The X-Ray Tube-Stand

There are many varieties and adaptations of this piece of apparatus. The chief essential is that the shield, whatever it may consist of, should be efficiently protective, and of a size capable of holding easily the largest tube. The clamps should have an easy movement, and as little metal as possible should enter into the structure of the shield and tube clamps. This is particularly desirable when heavy currents are used, for otherwise the current may spark from the tube to the metal, and lead to a marked diminution of current passing through the tube and to disappointment in results. The tube is frequently punctured if these precautions are not taken.

There is a type of protected tube-stand which, with some modifications, is made by all the principal manufacturers, and its essential points are enumerated below. Such a stand will answer very well, not only for therapeutic work, but in small installations for radiography and radioscopy. It consists of a wooden tube-box, lined with protective rubber, and as some of these boxes err on the small side, this is a point that should be noted. To the front of this box all diaphragms, applicators, and pastille-holders can be fitted. This box is attached to a horizontal wooden arm by a mechanical method, and this part should be carefully examined to avoid subsequent disappointment and annoyance. As the tube-box may have to carry considerable weight and still be used at all angles and positions, each movement should be controlled by a separate solid metal clamp, and not by one that can wear or compress. It is better to pay a little more for extra work in this direction than to court disaster by some part not holding well, and perhaps allowing the tube-box to drop in the middle of an exposure. The horizontal wooden arm has a rack-and-pinion adjustment, which is fitted by means of a bracket, with a vertical rack-and-pinion movement attached to a wooden upright, which in turn should be mounted on a solid metal base, not a wooden one, so as to make a stable and fairly rigid apparatus. All adjustments can then be conveniently made. An elaboration of this is the pillar tube-stand, suitable for use with much larger outfits and for all kinds of work.

**Description and Use of Pillar Stands.**—The pillar stand (Fig. 61) consists of a solid pedestal with castors, which carries a vertical column of

steel tube. An adjustable sleeve, to which one end of the wire is secured, is mounted on this column. The wire runs over a pulley, and carries a movable lead weight inside the steel tube, which serves to balance the tube-box and the whole movable system. The sleeve can be locked in any position by the lever. The pulley is secured to a ball-bearing, and can revolve freely round the top of the column. The sleeve has a horizontal

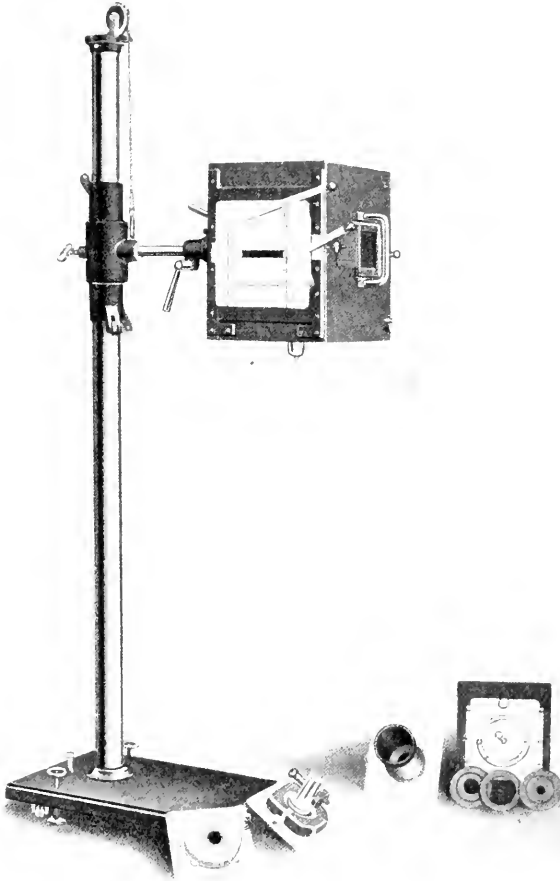

FIG. 61.—Pillar stand, protected tube-box and accessories. (Siemens.)

arm, which carries a second sleeve. In order to avoid a displacement of the sleeve in the longitudinal direction of the arm, the latter has a groove at the end, which engages the screw of the lever. The tube-box is hinged to the sleeve in such a manner that it may be revolved horizontally through an angle of about  $90^\circ$ . In order to fix the position of the angle, there is a circular slot above the hinge, through which travels the screw of the lever. If, now, the lever is turned to the right, its head is firmly pressed against the

slot, and thereby prevents any further rotation of the hinge. The sleeve, together with the tube-box, can be turned radially to the arm. The sleeve is locked by tightening up a screw by means of the lever, so that the sleeve is pressed on to the arm. Thus, the tube-box can be moved as follows: (*a*) up and down; (*b*) round the column; (*c*) round the arm; (*d*) through an angle of  $90^\circ$  round any axis vertical to the arm, so that this pillar stand permits of adjusting the position of the tube within the widest limits.

The tube-box itself is lined inside with lead rubber material, as a

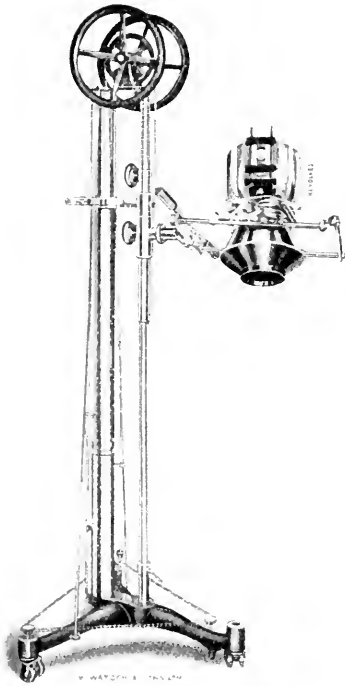

FIG. 62.—A form of tube-stand, which combines many useful mechanical movements. (Watson.)

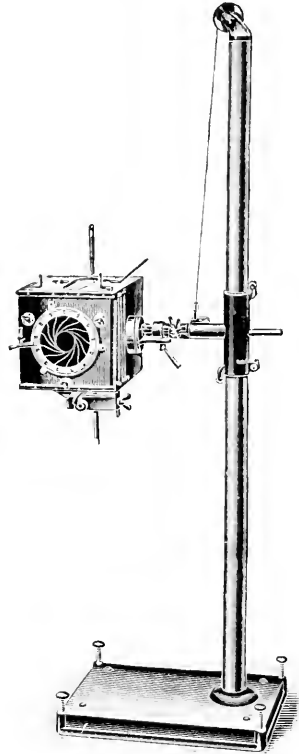

FIG. 63.—A convenient type of tube-stand with iris diaphragm.

protection against accidental effects of the rays. Its back forms a door. The front is provided with a rectangular opening of about  $170 \times 220$  mm., in which the accessories subsequently to be described are inserted. In order to be able conveniently to manipulate the tube-box during adjustment, it is provided with a handle. One of the sides is fitted with an observation window of lead glass, through which the X-rays can only penetrate with difficulty, and this may be closed by the shutter, when making a fluoroscopic examination. Two pieces of wood with slots are fitted to the under side of the box, between which the tube-holder, together with the tube

is inserted. The holder must be secured to the cathode neck of the tube. The latter must be so mounted that the anti-cathode is turned towards the front of the box (with the opening for the X-rays), and occupies about the centre of the box. The tube-holder can be fixed by turning the wood screw to the right.

In order that neither the operator nor the patient may receive shocks due to sparks jumping from the tube to any part of the stand, a terminal is mounted on the pedestal, which is connected with all the metal parts of the stand, and also with the accessories, which are inserted in the front opening of the box through the metal strip which runs along the tube-box. This terminal must be connected to a water-pipe by means

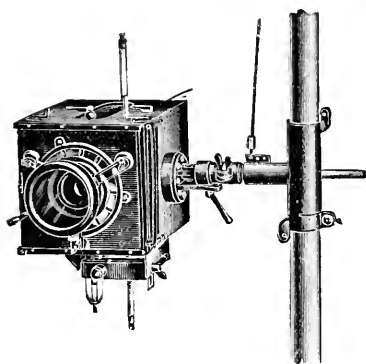

FIG. 64.—Tube-box with extension tube.

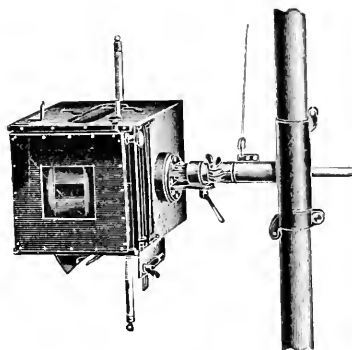

FIG. 65.—Tube-box with rectangular diaphragm.

of an insulated or bare wire, or to an earthed conductor, should this be available on the supply mains.

In order to prevent any accidental movement of the stand, two screws are provided in the pedestal by means of which the latter may be slightly raised, so as to put the two castors out of gear.

**Accessories.**—1. A wooden *Carrier* with an opening (about  $170 \times 170$  mm.), which is inserted in the front of the tube-box, and fixed by means of the screw. In order to centre the X-rays, it may be adjusted up and down to the extent of about 30 mm. The accessories mentioned subsequently, compressor diaphragm, iris diaphragm, and holders, can be attached to this carrier; for this purpose it is provided with a small spring, which snaps into a corresponding small slot in the accessories themselves, and thus prevents them from falling out when the tube-box is rotated. The carrier should be so inserted in the box that the spring is on the same side as the screw, so that the metal strip makes metallic connection with the strip on the opposite side, and thereby the metal parts of the carrier, as well as of the accessories which it carries, are earthed.

2. The *Compressor Diaphragm*, of about 140 mm. long by 125 mm. diameter, which serves, like the compressor diaphragm of Professor Dr. Albers-Schönberg, to produce radiographs with good contrasts, this being

attained primarily by screening the rays not required, and partly by efficiently fixing or compressing the patient.

3. An *Iris Diaphragm*, which must be inserted in the carrier in such a manner that the spring snaps into the slot. The largest diameter of the opening is about 105 mm. and the smallest about 25 mm.

4. A *Holder*, which must be inserted in the wood carrier, and is intended for holding the three diaphragms as well as the centering device. This holder must also be inserted in such a manner that the spring snaps into the corresponding slot. A *Holder* for the lead-glass tubes, or applicators, which must also be inserted in the wood carrier. The tubes can be fixed by turning a wooden screw.

5. Four *Lead Glass Tubes*, of 100 mm. length, with diameters of about 18, 40, 50, and 75 mm. respectively. The largest tube is conical, and should be inserted into the carrier at its widest end.

6. A *Centering Device*, which consists of a small metal tube attached to a circular plate, to the free end of which a small circular screen of barium platino cyanide is attached. The centering device must be inserted in the holder. In order to centre the tube, the latter is switched on, and the wood carrier with the centering device is moved until the small fluorescent screen is in a state of complete fluorescence, that is, until it shows a complete circle and not only a part of the circle. Centering can also be well effected without the tube being switched on, by removing the cap and the little screen from the centering tube, and observing the anti-cathode through the latter, and then adjusting the tube until the centre of the anti-cathode is observed.

7. A *Shutter Diaphragm*, the aperture of which can be variably adjusted by means of levers, in the form of a rectangle. The largest aperture is 120 × 120 mm.

8. *Holder for the Tubes*.—In order to avoid the unnecessary removal of the tube-holder from the tube, when another tube is employed, extra tube-holders are recommended, so that with this arrangement the tubes are always centered when they have once been adjusted.

9. A *Pastille Holder*.—This can be inserted in an opening in the base of the box, and is provided with a circular slot, in which the re-agents of the Saboraud and Noiré radiometers are inserted. By turning the metal piece the re-agents are prevented from falling out.

**Instructions for Use.**—The stand is earthed, as already described, by connecting the terminal by means of a wire with gas or water pipe, or possibly with the neutral wire of the supply mains. When moving the tube-box, the handle can always be held with one hand. In order to adjust the box, it should be brought to the desired position by loosening the lever, and then fixed rigidly at once by means of the same lever. This lever when loosened should only be turned so far as to enable the box to be easily revolved. Then the box can be turned into the desired position round the arm, and fixed again by means of a lever. Finally, the box is raised to the desired height, and if necessary rotated round the column,



and then tightened up again by means of the lever provided. Care should always be taken that the fixing screw for the tube-carrier is well tightened up, so that the wood carrier does not fall out when turning the box. Should it be desired to apply fluoroscopy or radiography to thick parts of the body, the wood carrier front may be completely removed.

## Couches and Stands

A **simple couch** will suffice for a small installation. In large institutions, where a considerable amount of work has to be got through quickly, a couch with mechanical contrivances is necessary. The couch should be

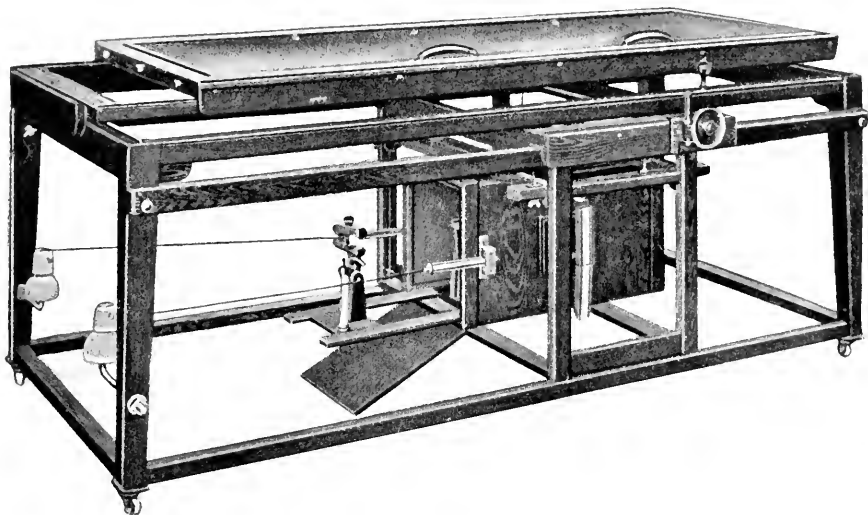

FIG. 66.—A convenient form of X-ray couch. (Siemens.)

Fitted with a protected tube-box, the top of the table is so constructed that the patient may be moved in several directions to facilitate centering of parts of the body over the X-ray tube.

sufficiently protected, and should have conveniences for working with the tube below the table. When possible overhead work should be undertaken.

This **compressor** is a most important piece of apparatus, mounted upon a suitable table with adjustments and tube-carriers, and is a great help to the radiographer, since it facilitates the work and saves time if the adjustments are easily worked. There are many forms to select from, and a great deal must be left to the individual worker.

The *Albers-Schönberg Compressor* is the best-known pattern, and such a compressor apparatus has become an absolutely essential auxiliary for radiography. The chief advantages which are guaranteed to the radiographer by its proper use may be briefly summarised as follows :

1. By means of the compressor diaphragm the secondary rays which affect the value of the radiograph can be screened completely.
2. The parts under examination can be kept absolutely at rest, so that



FIG. 67.—Albers-Schönberg compressor. (Siemens.)

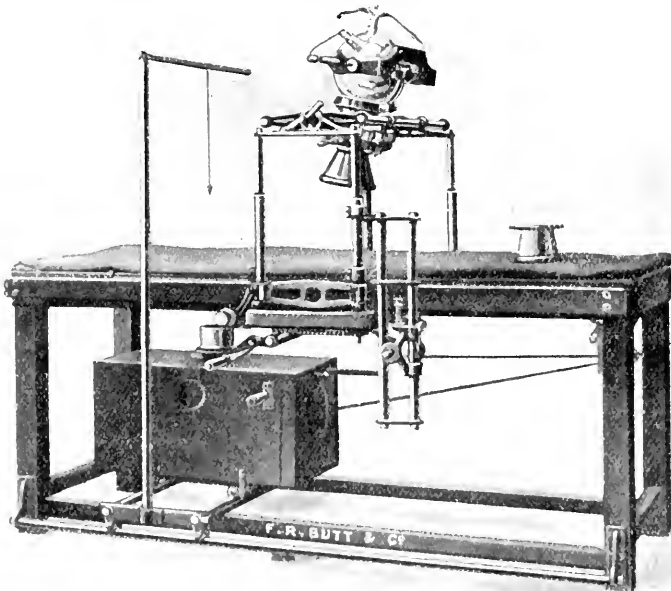

FIG. 68.—A couch fitted with protected tube-box underneath. (Butt.)

This has movements in three directions, and is arranged for stereoscopic work. An upright attached to the box carries a horizontal arm to which is fitted a plumb-line to indicate the exact position of the anti-cathode of the tube. On the upper aspect of the couch a movable tube-holder is fitted. This has attached to it a compression diaphragm. It is also arranged for the taking of stereoscopic negatives.

want of sharpness, due to voluntary or involuntary movement, to respiration or pulsation of the heart, is eliminated.

3. All parts of the human body can be radiographed, so that the compressor apparatus can be employed for all exposures required, with the exception of general exposures over a large area of the body.

It is now generally recognised that a certain quantity of X-rays are given off by the glass walls as well as by the other metal electrodes of the tube, in addition to the bulk of the X-rays emanating from the anti-cathode. Owing to the presence of inverse current in the tube, some cathode rays are produced from the anode, and others also start from the edges of the cathode, and these are all converted into secondary X-rays.

These secondary X-rays, which are produced in much larger quantities in hard than in soft tubes, are the primary cause of lack of definition, detail, and contrast; they produce general fog in negatives, and so lessen the value of the results of the more difficult radiographs.

The compressor apparatus consists of a lead-lined metal cylindrical or rectangular box, with an opening at the upper end for the insertion of diaphragms. The cylinder effectually absorbs and screens off all stray secondary rays, allowing only those X-rays emanating from the anti-cathode to reach the photographic plate. This can be proved at any time by observing a fluorescent screen placed below the cylinder, when a brightly illuminated centre only will be seen; a wider circle of fluorescence, indicating the presence of stray secondary rays, is only observed when inefficient diaphragms are employed.



FIG. 69.—Extension tube of a Kidwig compressor to show method of compression. (Siemens.)

By the time the X-rays have traversed the distance between the tube and the fluorescent screen or photographic plate, they have become very much diffused, and the thicker the subject the greater the diffusion. The primary object, therefore, is to reduce this distance in order to obtain quicker exposure and sharper and more brilliant radiographs, and for this purpose it is necessary to combine a compressor with the cylinder. The end of the cylinder is fitted with an ebonite rim, and the whole apparatus is raised and lowered by a lever.

Some parts of the human body can be compressed three or four inches without causing any discomfort to the patient, and the time of exposure is thus very greatly reduced. The compressor is also of great use in reducing the movement due to respiration, and thereby conduces to greater sharpness and definition in the radiograph.

There are modifications of this type of compressor which are preferred by some workers, and possess advantages over the Albers-Schönberg. The compressor introduced by Dr. Gilbert Scott possesses all the advantages

of the Schönberg apparatus, and is much more adaptable and easy of manipulation.

**The Upright Screening Stand.**—This useful piece of apparatus may be simple or very complicated, with conveniences for stereoscopic exposures. All movements must be easy. Several types of screening stands are illustrated. The most useful are Levy-Dorn, Wenckebach, the extremely

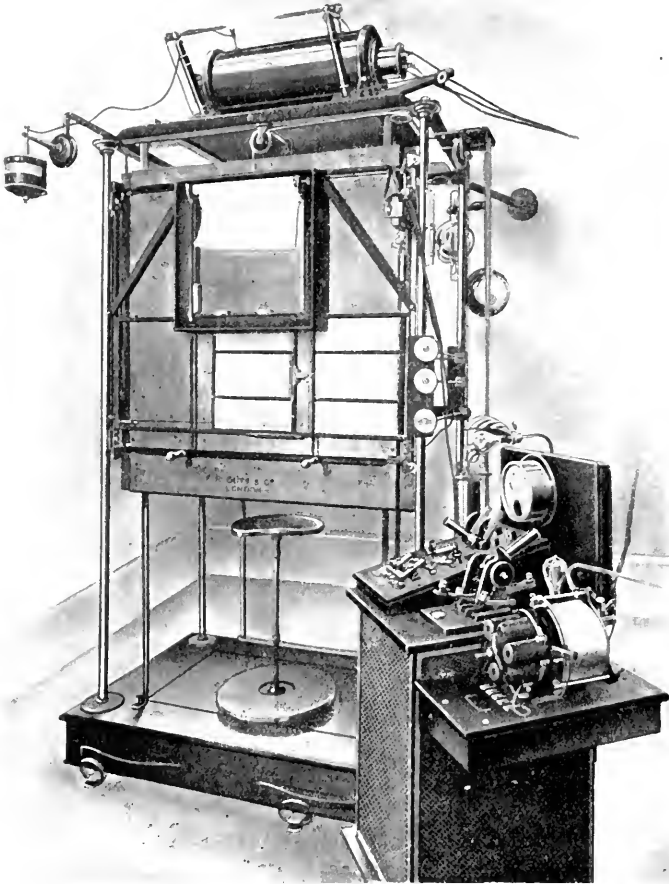

Fig. 70.—Screening stand arranged for stereoscopic work in the upright position. (Butt.)

The apparatus is arranged so that tube- and plate-holder move automatically at the right moment. The whole mechanism is controlled from the switch table.

ingenious but complicated one designed by Schmidt of Berlin, and the apparatus of Butt with automatic stereoscopic movements. Care should be taken to ensure the complete protection of the operator. The fluorescent screen should have protected handles, and the front must be protected by thick lead glass. This should be tested to make sure that it is efficient.

*The Levy Dorn Screening Stand* is constructed in such a manner that it

can be used for other purposes in addition to screening, and so it forms a very complete type of apparatus, particularly in small hospitals where the space devoted to the X-ray department is very limited. The apparatus consists essentially of a large, totally enclosed protective lined tube-box, with lead-glass observation window fitted with sliding shutter on one side; at the back is a door and on the front is fitted the diaphragm, compressor tube, and other pieces of apparatus. This tube-box is mounted on a carrying frame, which is fitted with slots, so that it can be brought nearer or taken further from the patient, also the whole box can be entirely rotated. The frame carrying the tube-box is attached to a strong square framework, running up and down between the upright sides of

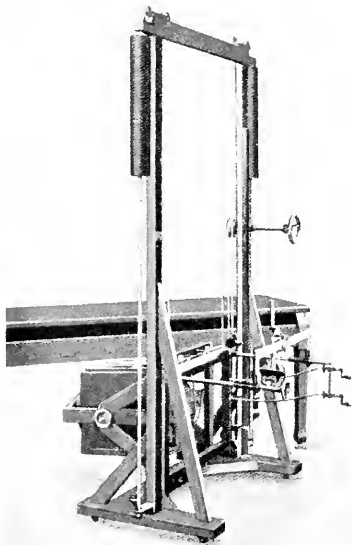

FIG. 71.—Screening stand arranged for work beneath the table. (Siemens.)

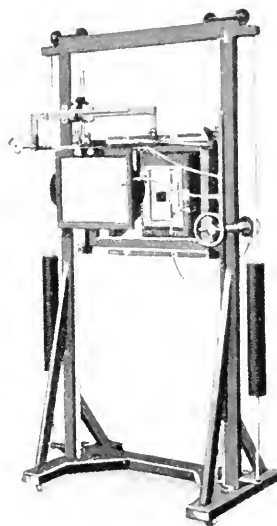

FIG. 72.—Screening stand arranged for examinations in the upright position. (Siemens.)

the stand. This frame is fitted with counterweights, so as to move freely up and down, and on the front of it are two rods projecting forward, and sliding on these rods is a metal carrier and carriage for holding the fluorescent screen or plate-holder, which can be angled to follow the contour of any part it is desired to examine or radiograph. The whole of the control of this apparatus can be manipulated from the front, so that it is entirely unnecessary for the operator to put his hands near the tube-box. As will be seen, the fluorescent screen can be moved freely across the patient by means of its own protective handles; the aperture of the diaphragm is controlled by means of the two flexible cables and handles seen on the right in Fig. 71; the handle on the left-hand side causes the tube-box to travel from side to side at the back, and the large wheel seen on the right is for raising and lowering the whole of the frame carrying the tube-box and screen-carrier. Now,

as to its other purposes, the tube-box can be lowered to the ground and rotated, a quarter-revolution bringing the opening of the tube-box towards the ceiling of the room. A couch or table can be moved over the box in this position, and examinations and radiographs made with the tube below. Or, on the other hand, the tube-box can be rotated from its screening position a quarter-turn in the other direction, so that the aperture is towards the floor. The frame carrying the tube-box can be now raised upwards, a compressor tube affixed, and the front of the box and a couch or table passed under or through the stand. The tube-box can now be lowered, and compression work undertaken as with an Albers-Schönberg compressor. If the tube-box be rotated a half-revolution, then the patient can be brought close up to the diaphragm, and on the other hand

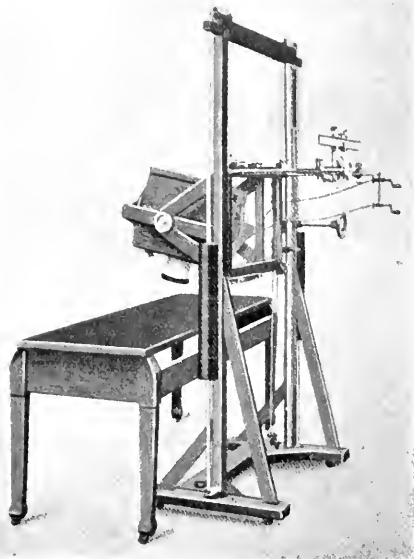

FIG. 73.—Screening stand arranged to work as a compressor. (Siemens.)

tele-radiographs can be accurately made with the aid of a simple centering arrangement provided with the apparatus.

*The Wenckebach Screening Stand* is somewhat different, and is constructed for screen examinations and exposures from the screening position only. It is, however, an excellent stand for those specialising in screen examinations. It is constructed in two units. One unit might be called the screen unit and the other the tube-box unit. The former consists of a frame carrying the fluorescent screen and plate-holder, which fits into a parchment frame marked with divisions, so that a note can be made of the exact position, and an examination repeated. This frame and screen is counterbalanced, and can be easily raised or lowered in a large upright framework. On the back of this framework are fitted at convenient intervals bands for passing round the patient to keep him in a fixed position. There is also a lamp which throws a light on the scales of the second part of the apparatus. The latter or second part consists of a large protective-lined tube-box, mounted on a frame which is carried on a second upright framework, and from this project forward, one on either side, two long arms with convenient wheel handles, one on the left-hand side for raising and lowering the tube-box, and one on the right for moving it across from side to side; also close beside the latter are the two flexible cables and handles for controlling the aperture of the diaphragm. This second part is mounted on rails laid in the floor, and the object of the long arms is that the operator, while making his screen examination, can push the tube further away, or draw it nearer the patient

with the utmost comfort and ease. A stool can also be provided to support the patient if necessary.

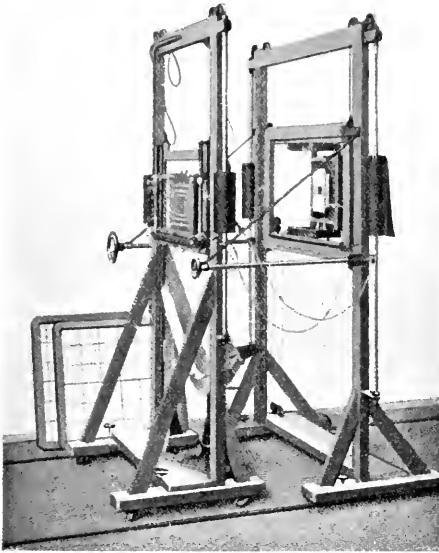

FIG. 74.—Wenckebach screening stand.  
(Siemens.)

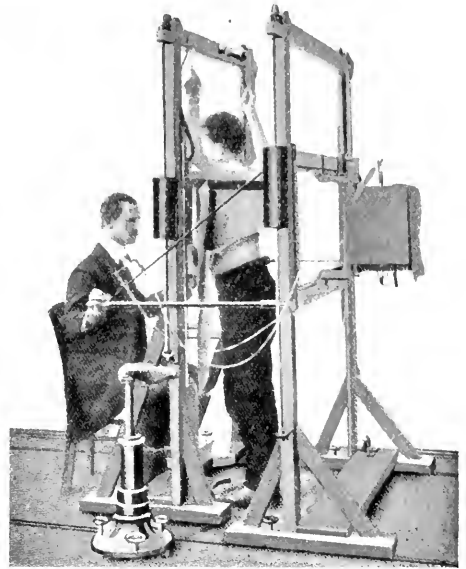

FIG. 75.—Wenckebach screening stand.  
(Siemens.)

**Universal Safety and Protective Tube-stand.**—The demand for a universal apparatus is increasing as the real importance of the Röntgen examination of the internal organs is recognised. There are, of course, various devices for radiographing the patient in a standing or sitting position, but a simple and handy universal apparatus for both fluoroscopy and radiography is much to be desired. The desiderata of such an apparatus are many. The most important of these are the fixation of the body, the straightness of the trunk, and the accurate adjustment of the normal ray to any desired point on the surface. In addition, any such apparatus, if it is to be universal, must be equally efficient when the patient is reclining, sitting, or standing, and should be easily adjustable for tele-radiography up to a distance of 2 metres or more. Finally, it should be capable of being easily and quickly handled, and it should not be too expensive.

First, as to the straightness of the trunk. It is absolutely essential that this should be as accurate as possible for exact radiography, and for localisation and measurement of the internal organs. Straightening by the eye is quite inadequate. The difficulty may be overcome satisfactorily by a mechanical device which carries out this straightening automatically. The trunk is often moved during the exposure, even by intelligent patients, and the picture thereby spoiled. This difficulty is partially overcome by instantaneous exposures of one-hundredth of a second or less; but, nevertheless, an efficient means of holding the patient is absolutely necessary since no movement should take place between the completion of the adjust-

ment of the part to be radiographed and the exposure of the negative. Moreover, it is of importance to minimise to a certain extent the costal and abdominal respiratory movements, especially in the radiography of the kidneys.

The apparatus shown in Fig. 76 is constructed from this point of view. It consists of a heavy base and framework, with a well-protected tube-box, which can be moved in all directions, the fluorescent screen being suspended by cords and counterpoises. There is in addition a special tube adjustment, and a set of rails and a small table for distance radiography.

The fixation board, which will take a plate-holder of any size, is furnished with three pairs of padded clamps, each pair being moved by the simple turning

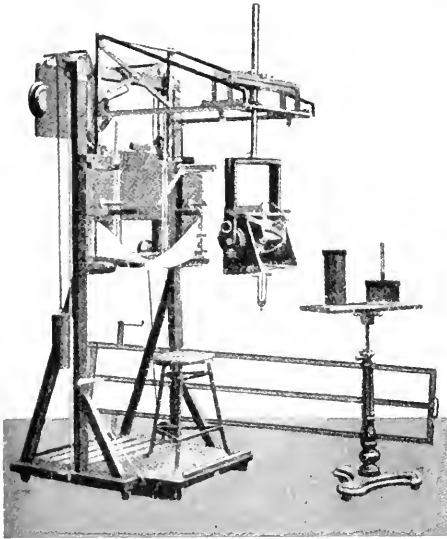

FIG. 76. — A useful form of universal examining stand. (Siemens.)

This combines nearly all the movements that are necessary for a complete examination, and is efficiently protected.

of a single handle, so that they are always at the same distance from the middle line of the board. The upper pair are made in the form of well-padded shoulder-caps, inclined in such a manner that, when brought together, they hold the patient's shoulders firmly, and at the same time press them against the plate-holder. To the top edge of the board is attached an adjustable support for the chin. Between the two lower pairs of clamps is a broad compression band, which can be readily tightened up by turning a handle. Another handle can raise or depress the plate-holder, so that even after the fixation of the trunk the plate may be brought to any required height, or depressed as much as 20 centimetres below

the board, for radiography of the pelvic organs.

In the centre of the supporting board is a large opening for the diaphragm tube, for use in radioscopy. There is also a receptacle for small cross-shaped lead labels, backed with plaster, which can easily be attached to any portion of the skin.

For radiography in a reclining position the fixation board may be detached from the framework. As it weighs only 40 pounds, it can easily be carried by one person, and placed on the X-ray table or ambulance.

The framework is 6 feet high, and is mounted on castors. It is provided with a small wooden frame with counterpoises, which is easily adjustable by means of a hand-wheel at the back. This carries the fixation board and clamps, and the guide rails for the tube-box and fluorescent screen.



For radiography of the stomach, the fixation board may be brought forward in an inclined position by means of two hinged wooden flaps.

The tube-box travels along the guide rails by means of an endless screw, and can be moved vertically as well as horizontally. The trolley which carries the spindle is locked in the central position by a spring, thus giving at once the position in which the focus of the tube and the normal ray are in line with the centre line of the fixation board, and therefore with the axis of the patient's body. The guide rails are graduated so as to give the exact distance of the focus from the plate. The tube is centred once for all by means of an adjustment tube attached to the diaphragm. It is supported in its wooden box by a wooden screw and three pads covered with felt.

The focus-tube adjuster is a tube at right angles to the plate and the body of the patient. This is moved about by a special slide till its aperture coincides with a point on the surface of the body which has previously been marked by a lead label. In order to focus the central normal ray, this tube is adjusted till the lead label coincides with the crossed threads in the tube, reflected by a small mirror, and viewed through a lateral eyepiece. The tube-adjuster is thus in every position perpendicular to the plane of the photographic plate, and its extremity is always exactly 50 centimetres from the plate. At the side of the tube-box is a spring tape-measure, by means of which the exact focus distance, up to 2 metres or more, may be determined.

The fluorescent screen is suspended by cords and counterpoises, and moves up and down in exact correspondence with the tube-box. Its movement is effected by means of a hand-wheel at the back of the apparatus.

For distant radiography the rails are attached to the foot-board, and a small table on three wheels placed on the rails. The tube-box is unscrewed from the spindle, and fixed in a slot in the far side of this table.

The principal uses of the apparatus are :

1. Radioscopy of the internal organs, under absolutely constant conditions.

2. Distant exposures (2 metres) with the patient vertical or horizontal.

3. Radiographic exposures of all kinds (universal tube-stand).

The examination of the internal organs may be made in the reclining, standing, or sitting positions. In order to straighten and fix the trunk, it is advisable, first, to bring the shoulder-caps in light contact with the shoulders, and then to lower the whole fixation board, with the attached overhead rails, firmly on to the shoulders, so that they are exactly at the same height. The handle is then turned until the shoulders are firmly pressed back against the plate-holder. When placed against the pads, the patient will naturally assist the adjustment by moving towards one side or the other, until the pressure of both sides is sensibly equal. The trunk itself is pressed against the plate, by tightening up the compressor band by means of the fourth handle.

After the patient has been fixed, the plate may be brought into the best position by turning the handle. The next thing is to mark with a lead cross the point on the surface of the body which has to be focussed, and the

centering tube is brought into immediate contact with this cross. Since this little focussing-tube is exactly in the centre line of the apparatus when held by the spring catch on the transverse rail, the centre line of the body—for instance, one of the spinous processes—must be brought into line with the tube by slightly turning the trunk. The tube may now be run back to the required distance as measured on the guide rails, and the normal ray remains accurately adjusted with regard to the specified point on the surface of the body: it may easily be readjusted at any time if required. For long exposures the tube-box can be kept more steady by supporting it also on the small table. With a little practice the whole process of straightening the trunk and fixing it, together with focussing and bringing the ray vertically on to the plate and determining the distance of the tube, can be performed in under one minute.

For a “standard exposure,” the question of the distance of the focustube from the plate is of the greatest importance. This “focus distance” should be constant. It is a matter of some difficulty to determine whether to make the “standard exposure” a short one, getting a sharp picture, but with considerable distortion; or whether to make it a distance exposure, say at 2 metres, with little distortion, but faint and often with hardly satisfactory definition. Apparently, there is only one solution of the problem at the present time—namely, to have two “standard focus distances”: 70 centimetres for near exposure, and 2 metres for distance exposures.

The advantage of teleröntgenography as avoiding distortion admits of little doubt, but this is of slight service at present, when such exposures are very seldom successful. The principle of the “standard exposure” necessitates conditions which are easily realisable by any one, viz. a near exposure of 70 centimetres. Such an exposure may now be made satisfactorily in a very short time. The focussing for a “standard exposure” can be carried out suitably once for all on the axis of the body, in which case the distortion of any internal organ, such as the heart, in the region of the centre line, is extremely slight. There remains a distortion of the contours towards the periphery. Alban Köhler and others have shown that the displacement of the image of the left edge of the heart is greater by 1 centimetre with a focus distance of 70 centimetres than with a focus distance of 2 metres. This error of 1 centimetre need not cause any perplexity so long as it is constant, and in proportion to the whole thorax picture and to the surface landmarks. If, for example, we have projected on the plate the mammillary line, a radiogram taken under similar conditions will always show the outer edge of the heart in a definite relation to this line and to the outer boundary of the thorax. The same holds good for distension of the aorta and for other departures from the normal. One can therefore make a diagnosis from the plate alone, on the assumption that the exposure is a “standard” one. The distance of 70 centimetres is recommended because it strikes the mean between distortion and good definition in the negative. The tube-director of the apparatus is adjusted for this

focus distance of 70 centimetres, so that no measurement whatever is necessary. Moreover, a locking device is attached to the guide rails at 70 centimetres, so that the standard distance is obtained automatically.

Finally, in order to give an indication on each plate that the “ standard exposure ” has been given, the position of the normal ray is indicated on each plate by the projection of the lead label on the specific “ landmark.” This is a check on the whole adjustment, and at the same time a characteristic sign of the particular normal exposure in question. As these anatomical points are constant for each region, they serve the purpose much better than the umbilicus usually employed, which is seldom selected as the focussing-point, and consequently varies in the position of its projection.

The following are the specific normal points, or Röntgen landmarks, for the examination of the internal organs. They are all on the median line of the body.

*Standard Points on the Median Lines at Various Levels.*

- Chest : 1. The xyphoid process (anterior position).  
 2. The line between the angles of the scapulae (posterior position).  
 Abdomen : 3. Line between the spines of the ilia (anterior position).  
 4. Line of the iliac crests (posterior position).  
 Pelvis : 5. The lower edge of the symphysis pubis.  
 6. The tip of the coccyx.

The landmark for the “ standard exposure ” of the hip-joint is the centre of Poupart’s ligament. This is the only landmark which is not median.

A flexible ruler is supplied with the apparatus, which renders it easy to obtain the exact position of the adherent lead disc, by marking on the skin the intersection of the median line with the transverse line.

Such anatomical points or landmarks have, however, the disadvantage that they cannot in every case be accurately determined, and are not always quite constant. With the Universal Apparatus, therefore, a set-square is supplied, which gives the Röntgen landmarks without further measurement. By a very simple device the distance from the shoulder to the crest of the ilium is measured, and divided into three equal sections. The upper division gives the level of the Röntgen point for chest exposures, and the lower division for stomach exposures, whether dorso-ventral or ventro-dorsal. These points are absolutely constant and easy to determine.

When reference is made to a “ standard radiogram ” of an internal organ, the first thought is of the heart, as the great aim of X-ray technique has always been to provide an accurate and useful picture of this vital organ. When it was impossible to reproduce the actual size of the heart, and even pictures with a similar amount of distortion could not be obtained, the orthodiagraph was devised to provide a tracing of the organ from a number of isolated points. At that time exposures of the internal organs were considerably below the present standard. By making an

orthodiagram one obtained, at any rate, a dotted normal projection of this organ, even although it was influenced somewhat by the personal factor of the operator. There were in addition several sources of error due to the process and to movements of the patient. All these disadvantages are avoided by the use of the modern rapid exposure with reinforcing screen. Moreover, it is difficult to take an entire orthodiagram during the same phase of diastole, and the drawing, which requires some time to make, often shows one part in diastole, another in systole. The tracing, therefore, often affords a much less accurate diagnosis than the photograph in which we have the united product of diastole and systole, and the contours are constant, and in their true relation to the margin of the thorax and other landmarks. By means of the small adjustable sector, it is easy to determine on the plate the constant line midway between the axis of the body and the outer edge of the ribs at the level of the diaphragm. The normal heart does not project beyond this line, and its margin forms a definite angle with the axis, which may be measured by the diagonal of the instrument. If now the sector be laid on the patient's chest, and the constant middle line is displaced 1 centimetre inwards, so as to correct for distortion of the shadow, we may draw the actual size of the heart on the skin, and check it by the image on the plate. In any case, this so-called "constant middle line" provides a landmark which is much more trustworthy than the extremely variable mammillary line. This constant line may be easily determined by using the sector.

In conclusion, we would draw attention to the importance of the "standard exposure" for examinations of the intestinal tract, where we have often to make a series of successive exposures of the same patient. An accurate comparison is impossible, except when the pictures have been made under exactly similar conditions. Further, it is of the greatest importance to know precisely the position of the pylorus, the fundus ventriculi, and the transverse colon. The possibility of incorrect diagnosis in consequence of variable adjustments should be altogether excluded.

**Universal Examining Chair.**—This chair is used chiefly for screen work and for superficial radiographs. The chief object in view in the design of the chair is to obtain as exact and as reliable a fixed position for the patient as possible. This is obtained by two wide straps fixed to the sail-cloth back of the chair, which hold the patient in an upright position, and by two easily adjustable axle supports, which prevent any movement sideways. The feet are well supported by a footstool, which may be adjusted to any height. When taking screen observations of the stomach, the seat can be replaced by a bicycle saddle, which is better suited for this work.

In order that the observer can undertake the examination of these parts in the most comfortable position, and without bending, it is necessary, after fixing the patient, to bring him to the height desired by the observer. This is attained by an oil pump which is built into the very massive base of the chair, and which is operated by pressure of the foot on a pedal. The locking of the chair takes place automatically after the foot is removed.

The fluorescent screen necessary for observation is secured by a holder fixed to the arms of the chair, and may be adjusted in all directions. In addition, the screen can be removed very easily, so that it may be replaced quickly by a dark slide containing the photographic plate.

Should it be desired, after the examination has been completed, to bring the patient back into the original position, it is only necessary to depress the second small pedal in order to release the locking device. Thereupon, the chair sinks slowly into the original position, owing to the excellent braking power of the pump.

The chair can be moved about easily, and may also be turned round its vertical axis with the foot, so that the hands of the radiographer need never come in the path of the rays.

#### Rieder's Exposure Stand.

—Another very useful piece of apparatus is an exposure stand, originally used by Dr. Rieder for taking radiographs, with the patient either sitting or standing. It is specially suitable for thorax, stomach, and abdomen exposures.

Another valuable addition is a little protective **lead-lined screen**, with an adjustable lead-lined sliding leaf, arranged with a clamp for fluorescent screen and plate-holder. This little apparatus should be mounted on good castors so as to move freely, and it can be used for many purposes. It is constructed primarily for the protection of the operator when screening, but it can also be used for the patient to stand against, and to support himself whilst being radiographed. It can be used in conjunction with any X-ray couch, screening-stand, or tube-stand, and also if a long therapeutic application has to be made this screen can be placed between the operator and the tube, so that no radiation from the latter falls on the operator.

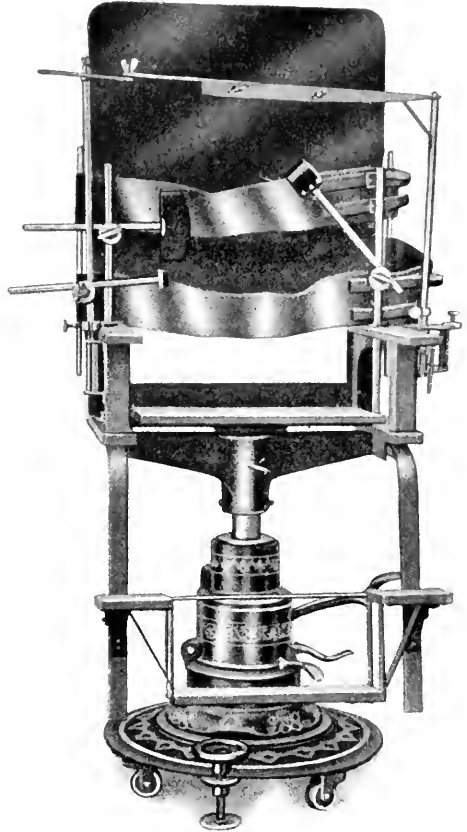

FIG. 77.—Examining chair fitted with mechanical movements to facilitate the rapid manipulation of the patient. (Siemens.)

## THE ARRANGEMENT OF APPARATUS

In a work of this size it is difficult to deal adequately with so wide a subject, but for practical purposes it will be sufficient to describe :

- (1) A small installation.
- (2) An installation for a general hospital or consulting radiologist.
- (3) An installation for a special hospital.
- (4) An installation (*a*) for a hospital for military service, (*b*) for field service.

Each scheme will be capable of modifications according to local demands, but the basis of each should form a working nucleus upon which the individual operator may build a complete scheme. A scheme for the arrangement of apparatus and a system of dealing with photographic details will also be included. A system of filing negatives and reports should be adopted in every department.

### 1. A Small Installation

There is a demand for small installations to meet the needs of practitioners desirous of examining their cases in the course of ordinary consultation, of school clinics, especially those where treatment is carried out, and where occasional radiosopic examination is required, and finally of small hospitals, where for various reasons an elaborate installation is not possible.

A comparatively large coil (say 15-inch spark-gap) is desirable. Further, a simple control apparatus is required, either mounted on the wall or preferably on a wheeled trolley ; and a mercury interrupter, with dielectric of paraffin or preferably of gas ; when rapid exposures are desired, an electrolytic interrupter should be added, and this necessitates a change-over switch in the control apparatus. In order to suppress reverse current, an adjustable spark-gap, introduced in the secondary circuit, is sufficient where small currents are used ; while for heavier discharges, obtained by using the electrolytic interrupter, valve tubes are necessary. A suitable tube-holder, with efficient protection and with the necessary fittings for therapeutic work is required, viz. tripod for treatment of ringworm, pastille holder, filters, etc. A simple examination-table with three-ply wood or canvas top, and a simple screening-stand are requisite. A vellum window may be fitted into a wooden frame which can be moved to any portion of the couch. This allows practically all the rays to pass through to the fluorescent screen, and gives the maximum value in screening. These may be combined in an apparatus which may be used for either purpose. A fluorescent screen,

protected with lead glass and provided with hand-guards, a supply of X-ray tubes, X-ray proof gloves, Benoist radiometer, oscilloscope tube, milliamperemeter, and photographic plates are also necessary. When instantaneous exposures are to be carried out, a cassette for plates with an intensifying screen must be added.

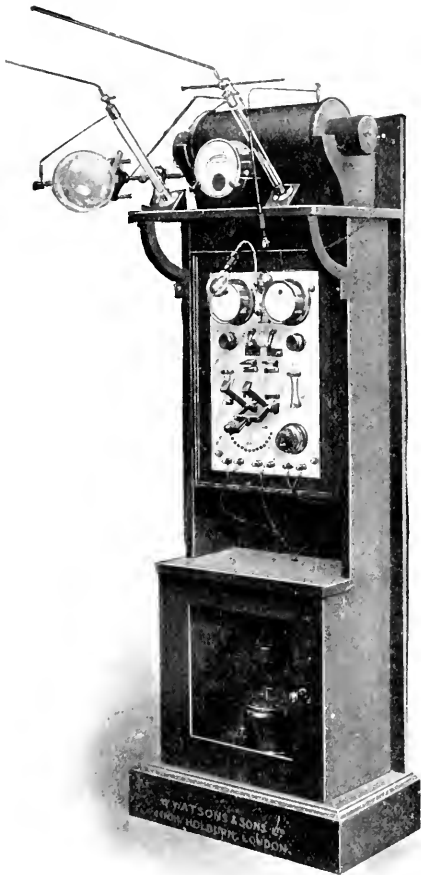

FIG. 78.—A convenient form of apparatus arranged on an upright cabinet. (Watson.)

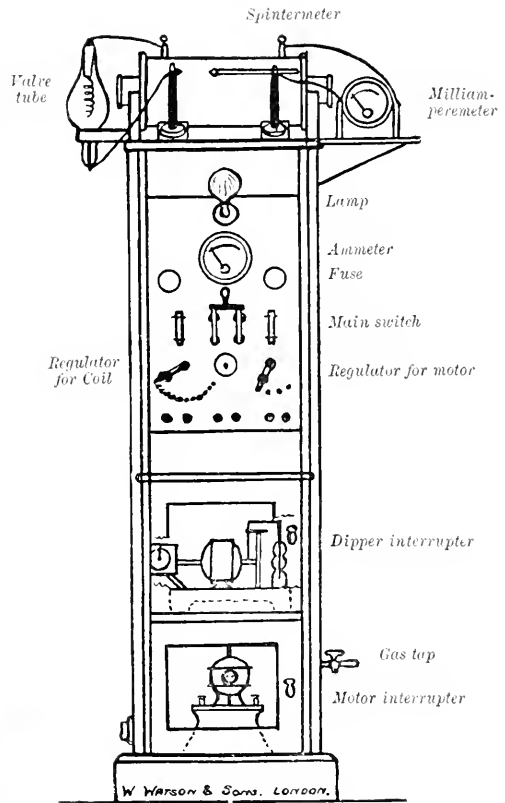

FIG. 79.—To illustrate the parts as arranged in Fig. 78.

**Portable Apparatus.**—This may take the form of a trolley outfit in a compact cabinet, capable of being wheeled from ward to ward, and obtaining its current supply from the electric mains. For work in private houses or institutions unprovided with electrical installation, it is necessary to have an outfit which derives its current supply from accumulators. Essentially it is the same as the small installation described above, but a 12-inch coil is for various reasons more convenient. A mercury-interrupter of the "Sanax" type is convenient; a tube-stand of lighter construction and a portable examination table may be added. The connections of the

accumulators are illustrated in the accompanying diagram. When exposing plates with a portable apparatus, a cassette and intensifying screen should be used, as these greatly shorten the length of exposure.

## 2. Installation for a General Hospital or Consulting Radiologist

The essential features of a somewhat more complex installation may be briefly enumerated.

(a) One or more coil outfits, with, where possible, a powerful instrument, such as a high-tension rectifier, a Snook machine, or a powerful coil outfit fitted with three breaks (mercury with gas dielectric, triple Wehnelt, and, if possible, a single-impulse switch). With a high-tension rectifier apparatus one can add a single-impulse switch.

(b) A second outfit of less capacity is useful as a stand-by in case of a break-down. This is an important point, because in a large institution work must go on constantly.

(c) Overhead high-tension cables, properly insulated, should be stretched from one end of the room to the other.

(d) A change-over switch is useful when two installations are used, and another switch for quickly connecting to various pieces of apparatus. This may also be accompanied by adjustable tube leads, running on wheels along the high-tension cables. The plan shown on p. 83 illustrates the best arrangement of apparatus when one room only is available. The various pieces of apparatus are marked on the plan.

The dark room should be in close proximity to the X-ray room, but care should be taken to ensure thorough protection of the unexposed plates and papers.

For large institutions a suite of rooms is necessary. The plan on page 84 shows the arrangement of rooms at King's College Hospital. The rooms are marked according to the use they are put to. When a separate building is available, it can be specially planned to meet the requirements of the institution.

Should it be necessary to plan an X-ray department, great care should be paid to the arrangements of the radiographic room. The lighting of this room should be carefully planned. A large window means that trouble will arise when it is necessary to darken the room, consequently the smallest possible window space must be allowed. The radiographic room must be large. It should have in close proximity to it a waiting-room, one or more dressing-rooms, and a preparation-room where patients may be anaesthetised or an opaque enema administered prior to taking the patient to the radiographic room. This room should have an adequate supply of hot and cold water and other conveniences. These additional rooms should open into the radiographic room. Doorways should be wide enough to allow of the passage of a large trolley.



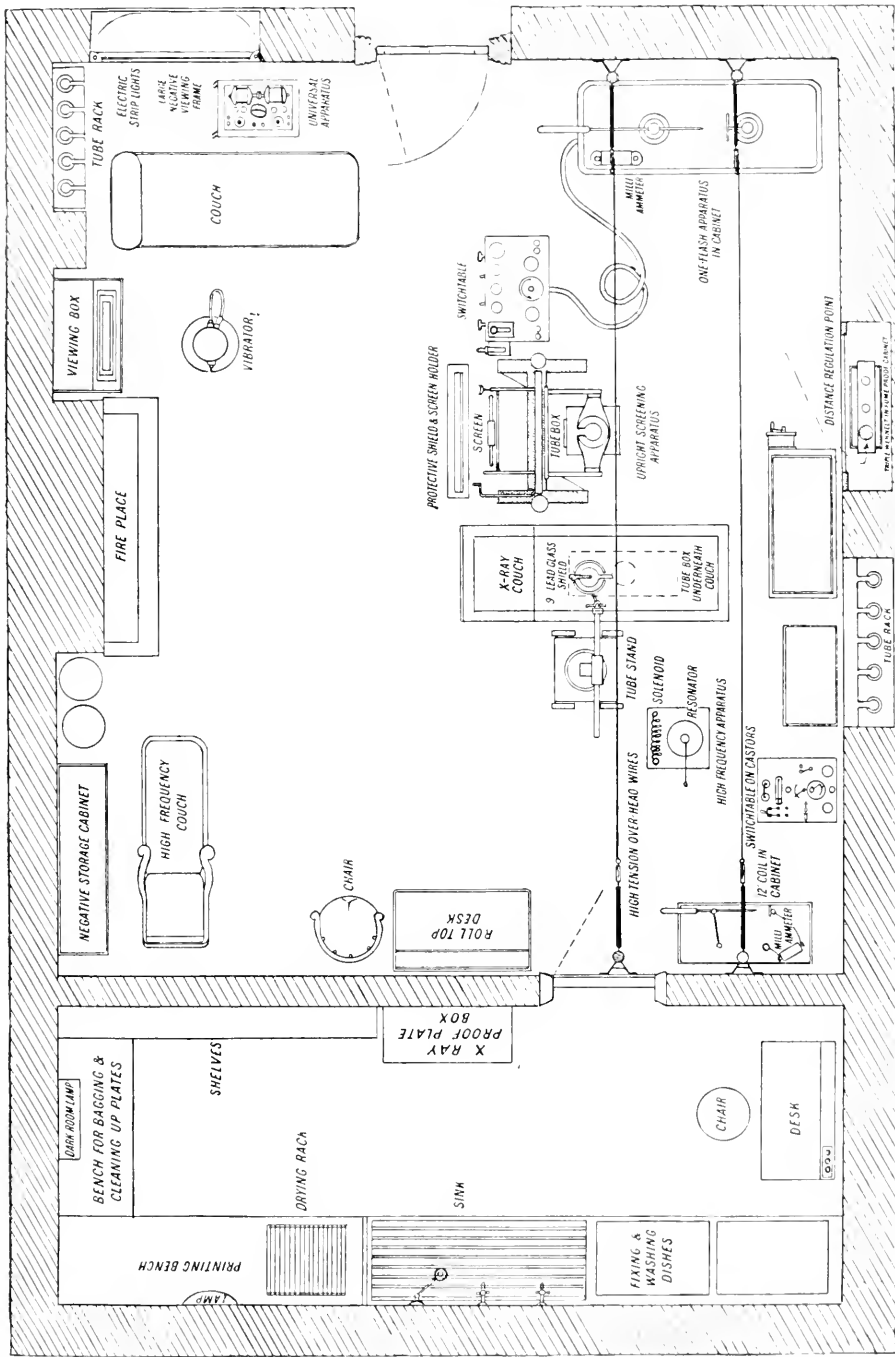

FIG. 80.—Plan for consulting-room or hospital outfit, showing method of arranging apparatus in order to facilitate rapid workings.

The equipment is arranged for radiographic and therapeutic work, and includes accessory apparatus, high frequency, galvanism and faradism, vibrator, etc.

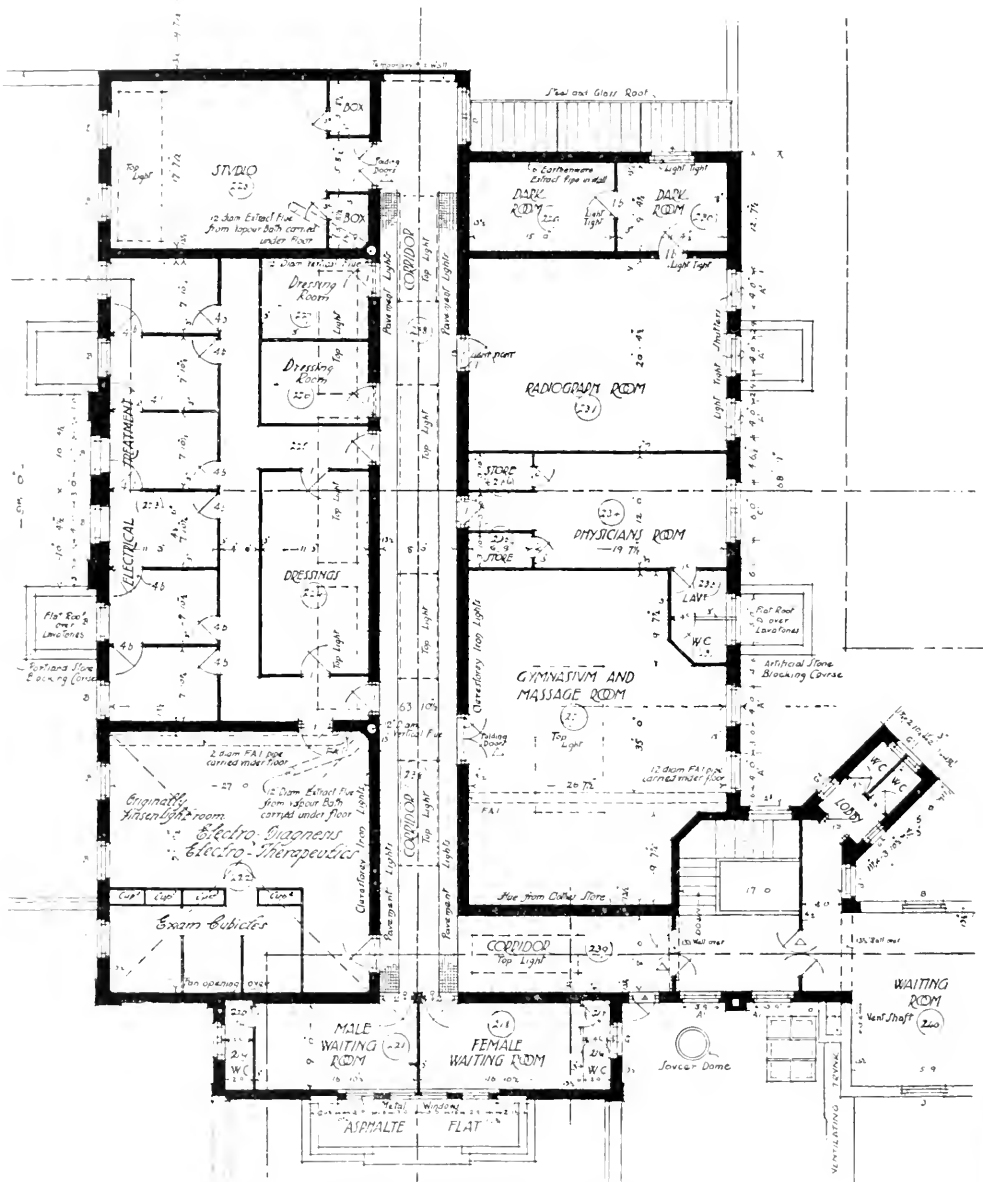

FIG. 51.—Plan of the X-ray and electrical departments at King's College Hospital. (By kind permission of W. A. Pike, Esq., F.R.I.B.A.)

The cubicles marked "electrical treatment" are fitted with X-ray installations. The room marked "dressings" has since been fitted up as an operating-theatre for electro-coagulation and for operations for removal of foreign bodies under X-rays.

### 3. Installation for a Special Hospital

The plan of an Electrical Institution is shown on page 86 ; this building was specially planned for the purpose, and is quite complete in details. The ground floor contains a waiting-hall with lavatory accommodation, a small consulting-room with dressing-rooms,—the former fitted with a desk, filing cabinet, and examination lamps, etc.

**The Radiographic Room.**—This contains the large single-impulse apparatus, with the regulating apparatus in a lead-lined protection cabinet. A couch and screening-stand form the chief accessory apparatus. Cupboards for tubes, etc., form part of the furniture of the room. There is a viewing-box, to take two 15 by 12 negatives, a stereoscope, and a large viewing-box, to take six 15 by 12 plates, each with removable fronts, adapted to hold smaller plates. Two dark rooms adjoin the radiographic room. The inner dark room is fitted with the viewing apparatus, which will be described in detail later.

**The First Floor.**—This is devoted to radio- and electro-therapy, and has, in addition to the special X-ray treatment cubicles, cubicles for carbon-dioxide snow work, radium treatment, diathermy, the mercury vapour lamp, Schnee four-celled bath, and galvanism and faradism.

A feature of this room, and also of one at a general hospital, is a small room fitted as an operating-room for diathermy, electro-coagulation, and operations for the removal of foreign bodies under X-rays. A photograph of one of these rooms is shown on page 266 to give some idea of the arrangement of apparatus.

**The Dark Room.**—When a large amount of work has to be got through it is necessary to have a large and well-equipped dark room, with possibly an outer dark room. This should contain cupboards for plates, papers, etc. A reducing lantern is useful for the supply of reduced prints, lantern slides, etc. The dark room should be carefully planned to facilitate speedy working. The entrance should be carefully guarded by two doors with an interval between. It is an advantage to have them so arranged that the two cannot be open at the same time. Shelving and cupboard accommodation should be provided. The ventilation should be good, and the heating of the room should be carefully attended to. Several lights are required: (*a*) Two or more ruby lights; (*b*) a yellow light for printing, etc. The development should be arranged for at one end of the room, a capacious sink with a good supply of hot and cold water being provided. Next to this is placed a washing tank, then a fixing tank or tanks, and lastly another washing tank. These should all be large and deep. A drying rack should be placed at this end of the room, and a viewing-box for inspection of the negatives when wet. Plates and papers should be kept in a cupboard at the opposite end of the room, if an outer dark room has not been provided.

In the largest hospitals the organisation of the electrical department becomes more involved. It is only when the whole department is under

efficient control that good work can be turned out in a routine manner. The efficiency, therefore, of such departments depends on thorough organisation more than on individual effort. All the workers must be trained to

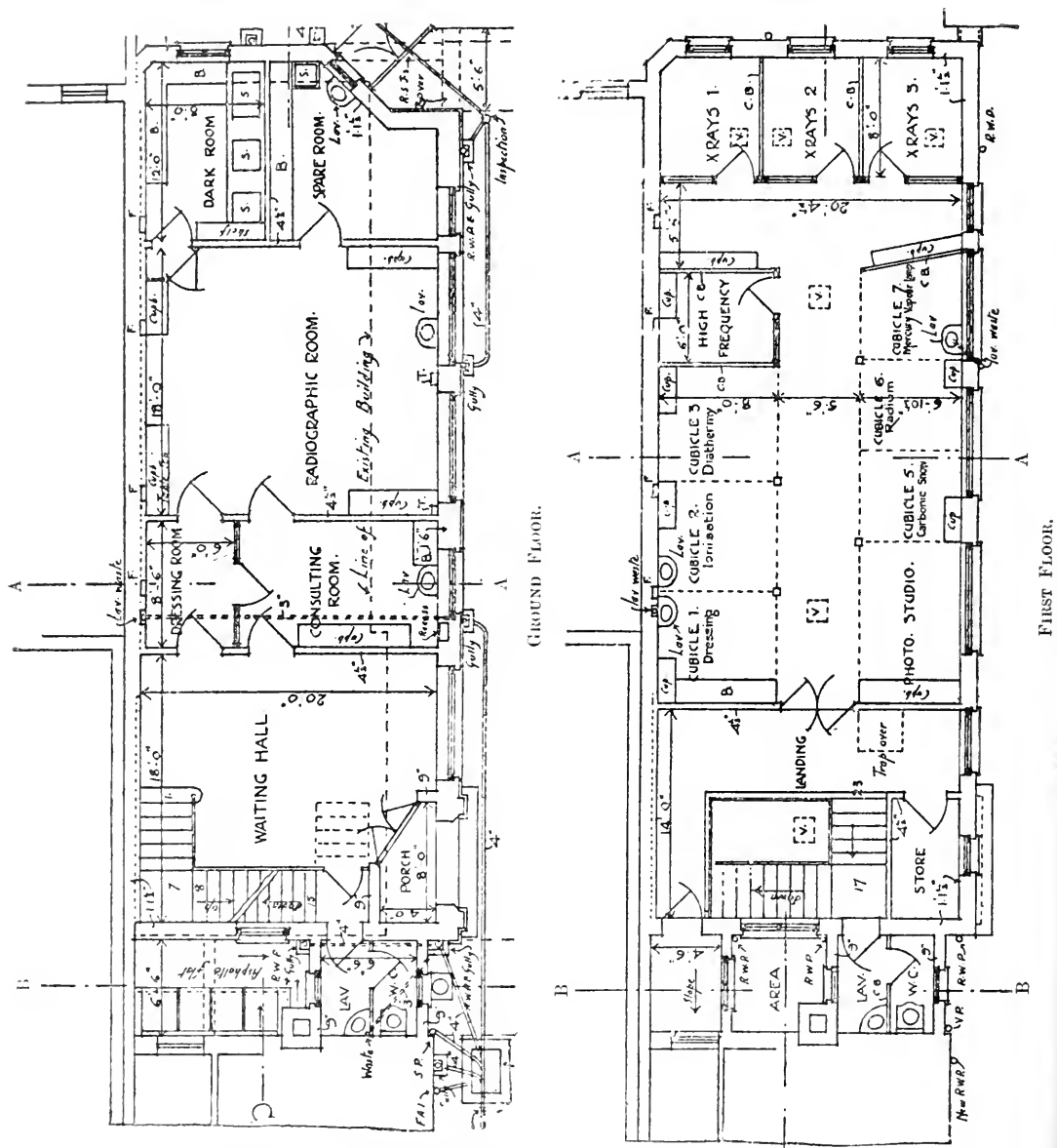

FIG. 82.—Plans of the electrical department at the Cancer Hospital, Fulham, (By kind permission of E. M. Pole, Esq.)

perform their particular part of the general whole in the most efficient manner possible.

#### 4. Installation for a Hospital for Military Service

**Equipment for Military Radiography.**—Radiography has been found to be of great use in the detection of fractures and foreign bodies. Its value therefore in the medical equipment of the military service is beyond doubt. Thorough equipment and organisation are necessary to obtain the maximum value, as it is often a matter of great difficulty to deal in the most efficient manner with the large amount of work which at times presents itself. The ideal scheme is one which is simple, comprehensive, and efficient, and this entails much preliminary detail work. An efficient scheme, and one which commends itself, consists of: (1) An installation at a base hospital, (2) a serviceable installation at a collecting hospital, (3) a portable outfit for use on the field.

(1) *The equipment at the base hospital* should be complete in every detail, because it is here that very important work must be thoroughly and expeditiously carried out.

The question of staff depends on the amount of work required, but the equipment suitable for a general hospital is suitable for such a base hospital. The advantages of a thorough equipment are other than purely radiographic, as it can be used as a training school where medical men, nurses, and orderlies can receive appropriate instruction in all branches of the work. Also it is here that cases requiring very careful investigation and exact localisation can be referred from the collecting centre.

(2) *The Collecting Hospital.*—This outfit should be more or less a stationary one, with ample conveniences for photographic work; but at the same time the apparatus should be arranged to allow of quick transport from place to place when the forces are moving rapidly.

The following apparatus should place a useful outfit in the hands of the radiographer: (1) **Electrical Supply.** To obtain the necessary electrical supply the choice lies between (a) accumulators and (b) petrol engine and dynamo. The latter is undoubtedly the better, though it is a good plan to include a set of accumulators which can be charged from the dynamo. The petrol engine and dynamo are mounted on a combination bed-plate; a magneto ignition carburettor fuel tank and radiator should form part of the set. At a speed of 700 revolutions per second the apparatus should generate 1 kilowatt or 100 volts and 10 amperes. The whole should be completed with shunt regulator switch-board for charging accumulators, and there should be a radiator for cooling purposes. This set should be arranged for direct connection to the X-ray apparatus. (2) A set of portable accumulator batteries consisting of six cells and 50 ampere-hour output. (3) A 12- or preferably a 15-inch portable coil with subdivided primary with a condenser and a small moto-magnetic interrupter; this will be found useful as a second break when the larger one is out of action. The coil should be fitted into a strong outer wooden case for transport. (4) The interrupter should be of good size, and one of the many mercury jet interrupters will be most suitable. The motor should be

wound to work at 100 volts on direct current, which is derived from the petrol electric set. (5) A small switch-board and rheostat with the auxiliary control switches should be included. This may be arranged in the form of a box, which, when closed, allows of ready transport. (6) A simple tube-stand with mechanical movements is necessary. It should be readily taken to pieces if required. (7) An X-ray couch. This should have folding legs, and should be light and fairly rigid. It should be constructed so as to allow of screening. (8) X-ray and valve tubes. It is well to have a good supply of these. When it is necessary to have the installation removed to another base they should be packed in large boxes, and should be suspended from the top or sides of the box so that they may not easily be broken in transit. Three to six tubes will form a good set for ordinary use. (9) A fluorescent screen fitted with

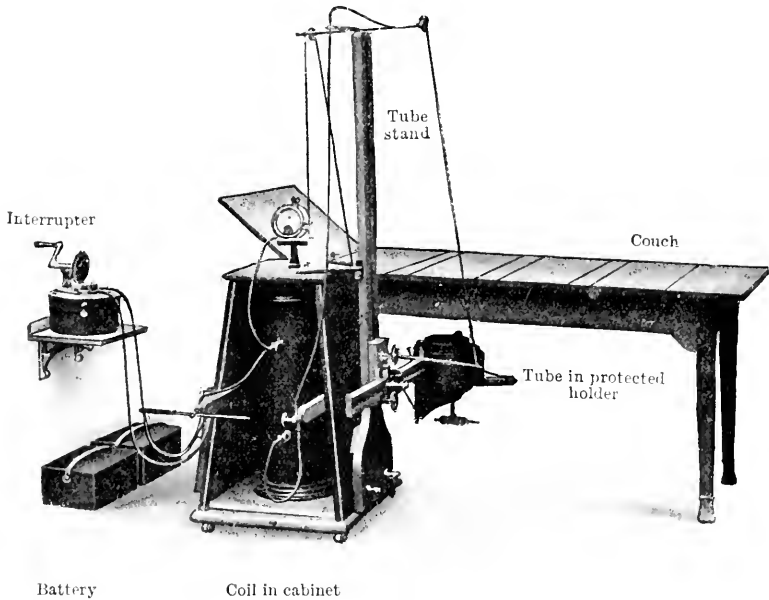

FIG. 83.—Portable X-ray installation arranged for radiography from beneath couch.

lead glass and protective rubber handles. Also several pairs of lead-lined gloves will be necessary. (10) Intensifying screens with cassettes. A simple form of localiser should be included. Photographic conveniences: these must be left to the calls of the particular place the installation has to serve. When a dark room is not available it must be provided for. A small dark room may be constructed of wood built in sections, or a tent may be requisitioned. The fittings should consist of lead-lined benches, with sink and waste pipe. A water-supply can be connected to the sink if such is available. A good supply of flexible tubing will be found useful when water has to be brought from a distance. A dark-room lamp with a safe light should be included. A candle will give sufficient illumination. (11) Developing dishes of sizes up to 12 inches by 14 inches, also draining racks, etc. (12) A supply of X-ray plates and X-ray paper. The latter is useful when it is not

convenient to use plates. An X-ray paper for direct radiography has been prepared. This, though not so good as the plate, is much more convenient for transport. (13) A supply of chemicals. The tabloid developers are very useful, as they are readily made up in a few minutes. The installation may be varied according to the needs of the radiographer, the important point being to provide a high standard of efficiency, combined with the possibility of rapid movement if such be required. The efficiency will depend upon the knowledge the operator has of his apparatus. He should be conversant with the mechanical details of all parts, and should be able to pack, re-install, and get into working order quickly. Practice will soon enable him to do all that



FIG. 84.—Portable X-ray installation packed ready for transit (Medical Supply Association).

is necessary. When a large amount of work has to be done, assistance must be available. One or more medical radiographers should accompany each installation, and several orderlies or nurses must be trained to carry on the work at any time.

In the case of large armies there must necessarily be several installations working at various places. To facilitate rapid work a system must be employed.

The difficult cases may be transferred to the hospitals at home if the patient is in a condition to travel and the symptoms are not urgent. By doing this the collecting hospitals are relieved of heavy work, involving much time, and are able to attend to the more urgent cases as they come in.

For localisation of foreign bodies several methods may be used ; these are fully described in the portion of the book dealing with localisation.

(3) *The Field Outfit*.—The essential is portability. The best arrangement for work on the field is a small but serviceable installation fitted up in a motor transport, the engine of which can be used to drive the dynamo which generates the electricity. By this means a more powerful installation can be used than when dealing with accumulators. The whole apparatus can be fitted up in a motor bus, a portion of which can be screened off to form a small dark room.

*Necessary Apparatus*.—(1) A dynamo, (2) mercury jet interrupter, (3) fifteen-inch coil, (4) X-ray couch with all accessories, (5) tube-stand with mechanical movements, (6) fluoroscope for screening, (7) plates, tubes, and dark-room requisites.

An extremely compact and portable outfit is illustrated on pages 88 and 89. It is most suitable for field work when petrol engine and dynamo are not available. It combines portability with considerable efficiency. It consists of :

(a) Set of accumulators.

(b) Hand-driven interrupter, which controls the current derived from the accumulators.

The method used for obtaining the required speed from the interrupters is somewhat ingenious, a cylindrical weight inside the interrupter giving the effect of a fly-wheel, and permitting a regular speed to be obtained.

(c) Coil enclosed in a cabinet which is arranged to form a complete case for the whole outfit.

(d) Tube-holder combined with the cabinet.

The small portable set when not in use for field work may be used for radiography of cases in the wards of the hospital. There are many patients who are not fit to be moved to the radiographic room ; such cases can conveniently be done in bed when a portable set is available.



## PRODUCTION OF THE RADIOGRAPH

The question of exposure in radiography is one which is ever before us. How long an exposure must we give for a particular region? Before making a statement on the question of time it is necessary to consider the various factors which govern the exposure.

### The Plate or Film Employed

This is the first point for consideration. X-ray plates are specially prepared for radiographic work, and any of those on the market are good. In this country the most suitable and best known are those of Ilford, Wellington, Warwick, Wratten, and the Barnet. The emulsion is spread over a sheet of glass, and the plate is enclosed in two light-tight envelopes. A second envelope is used to avoid the danger of fogging when one only is employed, by accidental admission of light or through pin holes in the paper.

These special X-ray plates are expensive, so when a large amount of work has to be got through, a cheaper plate may be used for the detection of fractures of the extremities. When a fine detail is not essential, as in determining the presence of a fracture or dislocation, any ordinary photographic plate can be used. The plate may be placed in a special cassette, in which case the black envelopes are not required. Care must be exercised in the dark room, when opening a box to take out a plate, to make sure that the light is "safe."

When the dark room is in close proximity to the radiographic room, some form of protection must be employed to prevent the plates from being fogged by X-rays. A box lined with several millimetres of lead will be sufficient to serve for the protection of these.

Manufacturers are endeavouring to produce a plate which will be much faster than those at present in use.

### Exposure

The length of the exposure depends upon :

- (1) The quality of the tube and the degree of penetration.
- (2) The strength of the current employed, the size and quality of the coil, and the type and frequency of the interrupter.

- (3) The thickness of the object.
- (4) The distance of the tube from the plate.
- (5) The rapidity of the X-ray plate.

**The Quality of the Tube.**—The operator must know the quality of his tubes well. A hard tube should rarely be used if good radiographs are required. A soft tube will give good detail in all the parts, but particularly of the soft parts, where a diagnosis is required of their condition. For fine detail in bones it is better to give long exposures with a soft tube, and trust to the increase in the time to give the necessary detail.

**The Intensity of the X-rays** is in proportion to the penetrating power of the tube multiplied by the number of milliamperes used. With one and the same tube, 1 milliampere for 60 seconds, or 2 milliamperes for 30 seconds, or 10 milliamperes for 6 seconds will produce the same effect on a plate. If tubes of different penetrating power are used, the number of milliampere-seconds required with a soft tube may be three to five times as great as that required with a hard one. To produce a certain density on a plate, 30 seconds' exposure with a current of 2 milliamperes may be sufficient with a hard tube, whereas with a soft one either 150 seconds may have to be given with a current of 2 milliamperes, or else 30 seconds with a current of 10 milliamperes.

The next factor in the calculation of the exposure is **the thickness of the subject**. Chest and abdomen, for instance, may have the same thickness, but if the latter requires 200 milliampere-seconds, 50 to 80 milliampere-seconds may be enough for the former, because the chest contains the lungs filled with air, whereas the contents of the abdomen have a greater atomic weight. For the same reason the head requires more milliampere-seconds than the chest, though both may have the same thickness. The intensity of the X-rays is in inverse proportion to the square of the **distance**. While one is aware that any increase of distance means prolongation of the exposure, it is a good point to get a good distance away from the plate. The farther the distance between the anti-cathode and the plate up to a limit of about 6 feet the sharper will be the resulting radiograph. At the distance of 6 feet a natural-sized picture is obtained, with no distortion. This distance may be employed when the exact size of an organ like the heart is desired; a good average working distance is about 2 feet for parts of average thickness.

A *slide rule* enables us to find out the necessary exposure approximately. The first scale contains figures for the distance between anti-cathode and plate, varying from 12 up to 200 cm. On the second scale, figures for the thickness of the object, varying from  $2\frac{1}{2}$  up to 50 cm., will be found. On the third scale is the penetrating power of the tube in Welmelt units, from 2 up to 18; and the fourth scale contains the figures for the milliamperes used, and rises from 0.5 up to 50 milliamperes.

By adjusting the two slides so that the figures for the distance, thickness, penetration, and current which are being used are opposite to one another, the index on the second slide points to the number of seconds required for the

exposure, which is on the fifth scale, beginning with  $\frac{1}{4}$  and rising up to 120 seconds.

On this basis it is possible to set down an Exposure Table which shall be of some practical utility to the beginner. There are of course so many special conditions that come into the matter that it is not possible to lay

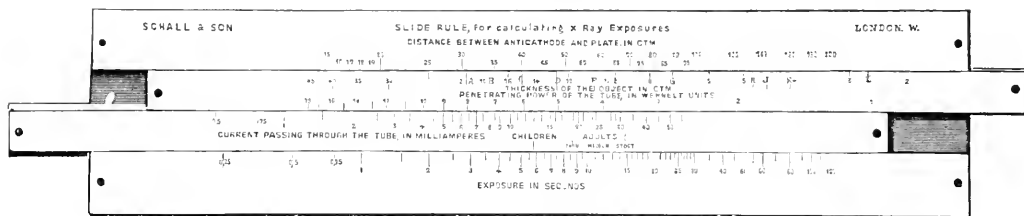

FIG. 85.—Slide rule.

down hard and fast rules. Actual experience with the outfit and tubes is essential, combined with the exercise of good judgment. The following table will therefore only be taken as a guide, remembering always that if the tube be softer or the distance greater the exposure must be correspondingly increased. The exposure must also be increased for abnormal stoutness, and so on. Above all, each focus tube, no matter what its degree of hardness, must be worked to just that extent which signifies maximum efficiency, neither under-running nor overstraining. This point is dealt with fully in the chapter on Tubes.

Object.	Distance from plate to anti-cathode.	Penetration.		
		Wehnelt Scale.	Benoist and Bauer.	M.A. Seconds.
	Inches.			
Skull, occipito-frontal . . . . .	18	9-10	6-7	90
Skull, transversely . . . . .	18	9-10	6-7	140
Skull, teeth (with film inside) . . . . .	15	8	5	15
Cervical vertebræ . . . . .	18	8-9	5-6	70
Shoulder . . . . .	18	7-8	5	80
Thorax . . . . .	18	7-8	5	80
Lumbar region . . . . .	18	8-9	5-6	180
Abdomen . . . . .	22-28	8-9	5-6	75
Ribs . . . . .	22	8-9	5-6	75
Knee-joint . . . . .	22	8	5	70
Femur . . . . .	18	9	6	90
Ankle and foot . . . . .	22	6-7	4-5	30
Wrist, hand . . . . .	18	6	4	12
Stomach (Bismuth meal) . . . . .	24	9-10	6-7	100
Kidney . . . . .	18	6-7	4-5	180
Pelvis . . . . .	24	9-10	6-7	200
Hip-joint . . . . .	24	9-10	6-7	150
Heart . . . . .	24	9	6	45
Lungs, diagnosis of early tuberculosis . . . . .	22	6-7	4-5	100

The above exposures are calculated without intensifying screen. If a screen be used, the exposures are reduced to about  $\frac{1}{10}$ th or  $\frac{1}{12}$ th.

Rapid radiographs in one or two seconds, or even fractions of a second,

are secured by powerful intensified coils of, say, 16-inch spark length running with centrifugal motor mercury interrupter, utilising a heavy primary current, and in conjunction with a good heavy-anode tube that has been well tuned up. After practical experience, and after becoming a thorough master over the peculiarities of his own outfit and his own focus tubes, the beginner will soon find that he is able to reduce exposures very considerably all round.

With a single-impulse apparatus radiographs of the chest may be obtained when an intensifying screen is used in  $\frac{1}{100}$  of a second. The more recent forms of this apparatus enable the worker to obtain good radiographs of stout patients in this time. For the abdomen the output of the apparatus is not sufficient to produce good results. In such instances recourse must be had to comparatively short-time exposures. With an automatic cut-out switch  $\frac{1}{10}$  or  $\frac{1}{4}$  of a second may then be sufficient. The aim of all workers is to produce instantaneous radiographs without the use of the intensifying screen. The Coolidge tube, with its capacity for passing heavy discharges, may be a means to this end.

EXPOSURE TABLES  
*Comparison of Different Radiometers*

Benoist . . . . .	2	2½	3	4	5	6	7	8	9	10
Benoist-Walter . . . . .	1	2	3	4	4½	5	5½	6	..	..
Walter . . . . .	2.3	3.4	4.5	5.6	6	6.7	7	7.8	..	..
Wehnelt . . . . .	1.8	3.3	4.9	6.5	7.2	8	9	10.5	13	15
Bauer . . . . .	1	2	3	4	5	6	7	8	9	10

*The Intensity of the X-rays varies with the Distance between Anti-cathode and Plate or Object.*—The intensity of the X-rays is in inverse proportion to the square of the distance. If we have to expose for a certain object 3 seconds, with a distance of 10 inches between the anti-cathode and the plate, the time of exposure required with

	10	12	16	20	25	30	40	50	60	80 inches
will be	3	4.32	7.68	12	18.75	27	48	75	108	192 seconds ;

or, expressed in other figures :

Distance	10	14.1	17.3	20	22.4	24.5	26.4	28.3	30 cm.
Exposure	10	20	30	40	50	60	70	80	90 M.A. seconds.

The distances usually chosen are :

For teeth, toes, fingers, or hands . . . . .	10 to 12 inches.
Arms, neck, leg, or foot . . . . .	12 ,, 15 ,,
Nose, head, shoulder, knee . . . . .	20 ,, 22 ,,
Chest, kidney, pelvis . . . . .	22 ,, 25 ,,

The distances given are approximate only. When the subject is fairly thick, it may be necessary to have the tube at a greater distance ; also, when the object from a diagnostic point of view is likely to be obscured by shadows thrown by structures in front of it, it will be found advantageous to have the tube close to the surface of the body.

## Caution

The distance chosen depends upon the thickness of the subject. At the longer distances we must employ apparatus of varying power, such as an intense single-impulse coil, or one of the forms of high-tension rectifier.

The additional advantage of working at long distances from the tube is that both the patient and the person screening are less likely to be damaged by the X-rays.

Care must be increased when working at a short distance, especially when repeated examinations of a particular patient are required, that the patient is not damaged. If work must be done at a close range it is wise to have in front of the tube a screen of aluminium 1 mm. thick. This does not cut off any of the penetrating rays, but retards the softer ones, which are likely to damage the skin.

The exposure times given on page 94 are only approximate, and should not be taken as an absolute guide. They illustrate the principle of exposures rather than the practice. Conditions vary with different apparatus, consequently the operator must clearly understand his outfit, particularly the X-ray tube. When very rapid exposures have to be made the difficulty of accurate work is increased, there being no great latitude upon which to work. Single-impulse exposures, when an intensifying screen is used, are comparatively easy, but even here the correct condition of the tube must be obtained if perfect radiographs have to be produced. A tube a trifle too hard will give an over-exposure, while a soft tube will give an under-exposure. It is possible that when tubes constructed on the principle of the Coolidge tube come into general use, the technique of exposure will require to be largely remodelled.

## The Adjustment of the Radiographic Plate

For X-ray examinations a special plate is employed. It is made more sensitive, and gives greater detail by reason of a thicker emulsion, containing more silver salt than the ordinary photographic plate.

The plate is placed in a cassette or two light-proof envelopes in the dark room, the film side of the plate being placed towards the object to be radiographed.

The centering of the plate is a matter of some importance, most modern couches having devices by which this may be done automatically. The best method of centering is one devised by Dr. Ironside Bruce, where the central ray from the tube can always be located by means of a plumb-line operating over the top of the couch. This may also be used for getting the centre of the plate exactly in the centre of the part to be examined.

The part of the patient to be examined should always be as close to the plate as possible. On the couch some form of compression must be employed to keep the parts as quiet as possible. When the screening-stand is used, the part is first examined by the aid of the fluorescent screen, and

the diaphragm adjusted to cover the part required. The fluorescent screen is replaced by the X-ray plate in a cassette and clamped in position, and the patient may be fixed by a strong linen band or a bandage. The shorter the exposure the less risk is there of movement on the part of the patient spoiling the result.

### The Use of the Intensifying Screen

Though negatives obtained by the use of the intensifying screen may not perhaps be of the same high technical quality as the best radiographs



FIG. 86.—Normal hand to illustrate value of an intensifying screen.

(*a*) An intensifying screen was used for this radiograph, the exposure being  $\frac{1}{10}$  of that for (*b*). The radiograph was considerably over-exposed.

(*b*) Taken without an intensifying screen with ten times the exposure. Note the detail in soft parts.

made by powerful installations without a screen, it should be noted that when skilfully used, pictures so obtained with apparatus of moderate power are, from a diagnostic point of view, of much greater value than those obtained without a screen. This is especially the case when radiographing parts of the body where movements are constantly going on, as in the chest and abdomen. The plate must not be over-exposed, otherwise grain, due to contact with the screen, is bound to appear. A soft tube also is necessary when the screen is used, and it should be noted that there is not quite the same degree of latitude in the matter of exposure, but when all conditions are correct, radiographs so obtained can hardly be distinguished from those taken without the aid of the intensifying screen. This applies not only to the plate, but more particularly to the print, and a little experience with an

average installation of moderate power and a screen will soon teach anyone how to obtain valuable diagnostic negatives, and enable the operator to do quick work, which would otherwise be beyond his reach.

For the purposes of diagnosis in regions such as the heart, lungs, stomach, or intestines, the value of radiographs so obtained cannot be overestimated, as with any of the modern intensifying screens it is quite possible to get results showing practically no grain.

It is most important that every care should be taken to avoid damage to the delicate surface of the screen, because any scratches or other markings causing an abrasion of the surface will certainly be produced on the negatives.

Before placing the screen in the holder it should be carefully dusted with a wide camel-hair brush. The film side of the plate is brought into contact with the fluorescent coating on the screen, care being taken to avoid rubbing the surfaces together. When making the exposure the film side of the plate should face the X-ray tube. When the screen is not in use it should be placed in such a position that it cannot get damaged or splashed with chemicals. The value of an intensifying screen is illustrated by the figures on the opposite page.

## Development

The general description of the dark room has been given in the chapter on the arrangement of apparatus, etc. It is essential to take the same care in the development of X-ray plates as is necessary in developing the fastest of ordinary photographic plates.

Specially prepared X-ray plates are slightly sensitive to red light, and care must, therefore, be taken to avoid more light falling on the plate during development than is really necessary. This can be accomplished in the following ways :

1. The employment of a carefully tested "safe-light" glass in front of the source of illumination. This screen must be tested in the conditions under which it will work ; thus, if electric light is used, a bulb of the same candle-power should always be used in the lamp.

2. The electric bulb may be immersed in a solution coloured by bichromate of potash and an aniline dye. To ensure greater safety the globe containing the lamp should be covered with a layer of yellow and ruby fabric. Provided exposure is not unduly prolonged, the X-ray plates may be developed in this light. The dark room lamp should have in a convenient place a switch in order that the light may be turned off when developing the plate.

3. A cover to fit the developing dish may be placed over it immediately the plate is immersed, and not removed for several minutes, as it is in the early stages of development that plates are most easily fogged.

4. The plate may be developed in the dark.

**The Choice of a Developer.**—Any properly balanced developer can

be used, the majority of workers using that recommended by the makers of the plates. Of these (1) Metol-hydrokinone, (2) glycine, (3) rodinol, (4) pyro-soda are the most commonly used, and each has its own advocate. The formula for one of the most largely used—metol-hydrokinone—is :—Metol, 20 grains ; hydrokinone, 80 grains ; sodii sulphite (crystals), 2 oz. ; sodii carbonate (crystals), 2 oz. ; potassii bromide solution (10 per cent.), 80 minims ; water, 20 oz.

**The Preparation of the Developer.**—(1) The metol must first be dissolved in 8 ounces of pure water (warm). When thoroughly dissolved the hydrokinone is added.

(2) The sodas and bromide are then dissolved in a further 8 ounces of warm water, the two solutions mixed, and made up to 20 ounces.

It is most important that each ingredient be allowed to dissolve thoroughly before the next is added. The developer is then allowed to cool, and to ensure the best results, should be used at a temperature of 60° F. The following facts explain the reason for this insistence on a uniform temperature : Metol and hydrokinone act differently on the photographic plate, metol being employed to obtain good detail, while the hydrokinone ensures density. The hydrokinone acts best at a temperature of about 65°, and becomes practically inert below 45°, and, therefore, in order to ensure that both agents act to the best advantage, it is necessary to work at about 60°. For this reason in cold weather the dark room should be kept at a little above 60°, and at a level temperature, in order that the dishes and solutions should not fall much below. In very cold weather, when plates are obtained which are lacking in density, but show fine detail,—when all other factors employed in the exposure of the plate have been favourable, and a good strong negative was expected—the explanation is often found to be a faulty temperature of the developer.

**Caution.**—If the metol is not allowed to dissolve thoroughly before the other chemicals are added, it will crystallise, and be precipitated in the form of granules. Should any of these settle on the plate during the process of development, small black spots with soft edges are likely to appear in those places where the granules have settled. Moreover, in using the developer improperly made up, the full strength is not available, and such conditions may account for failure to obtain the best possible results. A freshly made developer should be almost transparent in appearance and free from colour ; stale developer is from a light- to a dark-brown in colour. In hospitals and similar institutions, and with many radiographers, the practice is to have the developer made up by the chemist or his assistant, who does not understand the importance of extreme purity of chemicals and exact weighing, and so frequently sends up a hastily prepared developer which may spoil many otherwise good results. In large institutions a skilled photographer should be attached to the department, whose duty it should be to attend to the preparation of all solutions used.

When specially good negatives are desired it is a good plan to have a stock solution of sodium sulphite and carbonate in the proper proportions



ready at hand. The metol and hydrokinone are then freshly prepared in warm water when wanted, and added as required, as is also the bromide solution. If these points are attended to, there should be no difficulty in obtaining really first-class negatives. The developing solution should not be used for more than three or four plates in succession; if used too often it becomes oxidised by exposure to the air, and ceases to yield satisfactory results.

A developer which has already been used for a number of plates should not be kept for further use. Oxidation having commenced will continue until the solution ultimately becomes nearly black and quite useless. The freshly made metol and hydrokinone, if kept in properly stoppered bottles, will keep in good condition for a considerable time.

With normal exposures the image appears in about fifteen seconds, and development is complete in four to five minutes; but in cases where the exposure has been very short, the image appears more slowly, and the time of development is proportionately longer. Where instantaneous exposures have been given, such, for instance, as  $\frac{1}{50}$  of a second, development from fifteen to twenty minutes may be necessary in order to secure the desired results. Under these circumstances it is advisable to keep the developing dish covered over in order to avoid any possibility of fog from prolonged exposure to the dark room light during the process of development; and the dish should be gently rocked until development is complete. The use of a weak or highly restrained developer should be avoided.

## Fixing

After development the plate should be rinsed for at least thirty seconds before placing in the following fixing-bath:

Hyposulphite of soda, 1 lb.; potassium metabisulphite,  $\frac{1}{2}$  oz.; water to 80 oz.

If the fixing-bath is required for immediate use it is advisable to dissolve the potassium metabisulphite before adding the hypo, but hot water should not be used for the purpose.

Allow the negative to remain in the hypo bath until thoroughly fixed, and on no account examine a partially fixed plate by daylight, or stains will appear on the film which cannot afterwards be washed out.

If the plate is not washed free from developer before being placed in the fixing-bath, yellow stains will appear on the film which are very difficult to remove.

## Washing and Drying

After complete fixation, the plate should be washed in running water for at least one hour, and then placed in a well-ventilated room, free from dust, until dry. If a negative is required for use immediately after development, fixing, and washing, it may be dried rapidly by the following method:

The surface moisture is first removed by allowing the plate to drain, or it may be carefully removed with a wad of cotton-wool or a pad of fine chamois leather. It is then placed in a methylated spirit bath for four or five minutes, and rocked as in development. It is then removed, and placed in a current of air or in front of an electric fan, when it will dry very rapidly, or it may be placed in a specially arranged drying-oven.

## Reduction

It is sometimes necessary to reduce a developed plate which has been made too dense. The following solution will be found very useful for the purpose : Potassium ferrieyanide, 120 grains ; water to 20 oz. A dram or two of this is added, just before using, to each ounce of ordinary hypo solution as used for fixing photographic plates, *i.e.* hypo, 4 oz. ; water to 20 oz. The plate is immersed in the reducer when it is to be acted on all over, or if for local use, the solution is applied with a little tuft of cotton-wool. The plate after reduction is well washed and dried.

## Intensification

Negatives which are not sufficiently vigorous owing to some error in manipulation may be greatly improved by the process of intensification. The film should first be hardened in the following bath : Formalin, 1 part ; water, 10 parts. In this bath the negative should be allowed to remain for five minutes, after which it should be rinsed for a few minutes, and then placed for exactly one minute in the following bath : Potassium ferrieyanide, 20 grains ; potassium bromide, 20 grains ; water to 20 oz.

Too long an immersion causes the image to bleach, and this should be avoided if it is desired to retain the original gradation. In the time prescribed there is no apparent change, but the clearing agent has done its work, which is the prevention of green fog in the subsequent process of intensification. The negative should now be rinsed for a few minutes, and then intensified in the following stock solutions :

(a) Silver nitrate, 800 grains ; distilled water to 20 oz.

(b) Ammonium sulphocyanide, 1400 grains ; hypo, 1400 grains ; water to 20 oz.

Half an ounce of (a) should be taken and added slowly to half an ounce of (b), stirring vigorously with a glass rod. Sufficient silver nitrate solution must be added until the precipitate formed is dissolved with difficulty. To this solution should be added : 1 dram of a 10 per cent. solution of pyro preserved with sulphite, 2 drams of a 10 per cent. solution of ammonia.

The negative should be placed in a chemically clean dish, and the silver nitrate solution poured over it. In a minute or two the deposition of the silver begins to take place, and as soon as sufficient density has been acquired, the negative should be placed in an acid fixing-bath until the slight pyro stain is removed. After this bath the negative should be well washed, it

being well, during washing, to lightly rub the surface of the film with a tuft of cotton wool to remove the slight surface deposit which will be found upon it. It is important that the negative to be intensified must have been thoroughly fixed in a clean, fresh hypo bath, and not merely have been left for some indefinite period in a stale or dirty solution of hypo that has been used on other occasions. A useful method is to bleach the washed negative in a saturated solution of perchloride of mercury, wash well, and then place in a strong solution of ammonia.

## Printing

The printing of an X-ray negative is an art which is too often neglected by the radiographer. A well-finished print, nicely glazed and suitably mounted, is the finished work of the expert, and should always be aimed at, slovenliness here being quite inexcusable. It must be remembered that the average plate will produce a print which will explain the conditions found, and in the majority of cases it is on the print that the radiographer is judged. Consequently it should always be the aim to turn out a good print. The three papers commonly used in printing are :

(1) Bromide paper.      (2) Gas-light paper.      (3) Silver paper.

Nos. 1 and 2 are the most frequently used because of the conveniences they offer. The best prints are undoubtedly obtained by using P.O.P. paper, the difficulty being, however, that a strong light is required, and the operator is dependent in the majority of cases on daylight conditions. When daylight is not available these papers may still be used by the aid of an arc lamp, by the use of which a negative may be printed in from ten to fifteen minutes.

The toning and fixing of papers so prepared is a little more troublesome than when papers (1) and (2) are employed, which possess the advantage over silver paper that they give the operator the opportunity of producing a good print by careful development, as by careful manipulation prints of good diagnostic value can be obtained from very indifferent plates. It must be insisted upon that the touching in of detail should never be practised in radiographic work. Though largely used in artistic photography, it has no field here.

In hospitals and in private practice, where large plates are used and several are taken of the same subject, reduced prints may be obtained by the use of a reducing lantern. By using an apparatus of this kind it is possible to obtain in a small space prints of the largest plates. These may be mounted in series on a large mount, and despatched to the physician or surgeon in charge of the patient. These reduced positives are quite sharp, show all the detail of the large prints, and may be included in the notes of a case. Plates when dried should be carefully cleaned and particulars attached to them. When examined and reported on, they should be filed away and indexed. The card index system will be found most useful for this purpose. Special cards may be printed to suit individual requirements.

### Further Points in Exposure and Development

It is worthy of note that a practical knowledge of photography is very helpful to the radiographer, and in no part of his work more so than in the development of his plates. Fortunately for the majority of workers whose

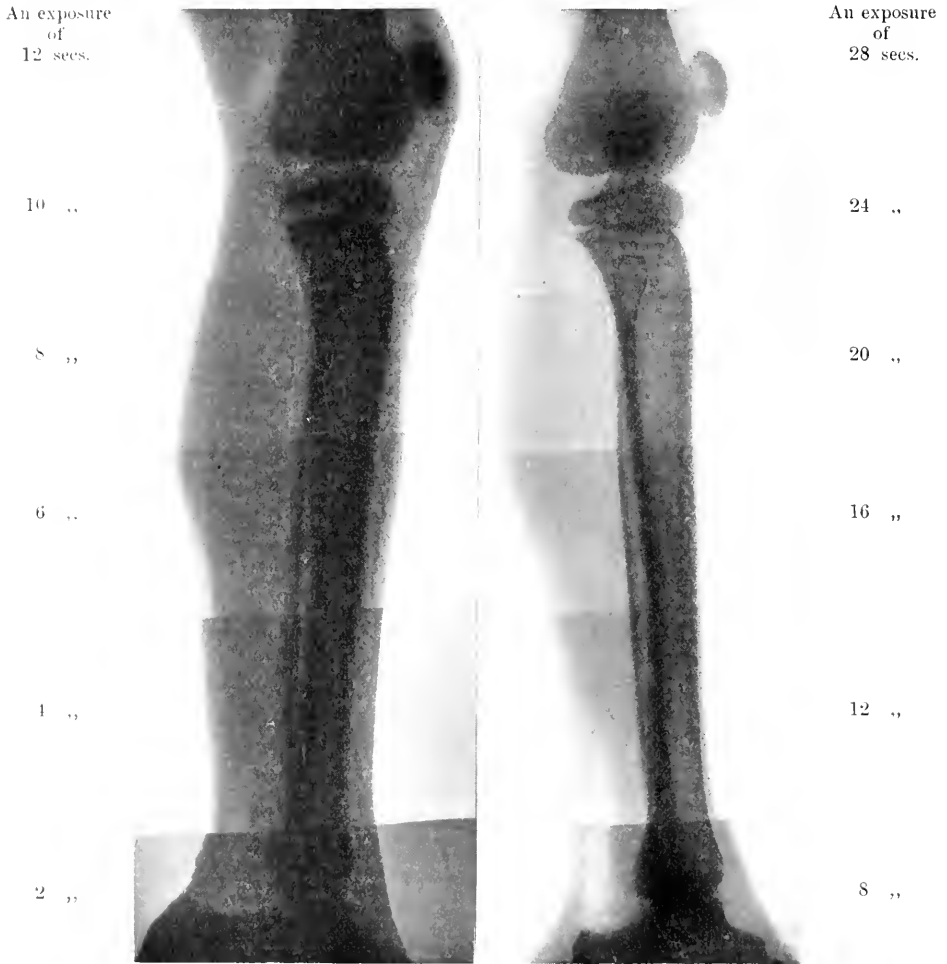

FIG. 87.—To illustrate the latitude of exposure. Each of the twelve exposures gives a good negative. These exposures were made with a moderately soft tube.

knowledge of photography is slight, considerable latitude in the exposure time exists.

*First Experiment.*—In the course of a number of experiments performed for the purpose of ascertaining this point, it was found that if a limb of even thickness was radiographed, being divided into areas which allowed of twelve exposures of different duration, commencing with 2 seconds and ranging up to 20 to 30 seconds, useful negatives were obtained from each exposure.

The development was necessarily uniform, as all the exposures were on the one plate.

*Second Experiment.*—On this occasion the same duration of exposure was given to each part, and it was found that useful negatives were obtained by varying the time of development.

*Third Experiment.*—This experiment was carried out with a view to ascertaining the influence of temperature on the action of the developing agent. A wide range of variations was found which are very instructive. Using the same exposure for two plates and developing them side by side, one solution being about 20 per cent. colder than the other, it was found that at a temperature of 60° development was rapid, detail good, and density

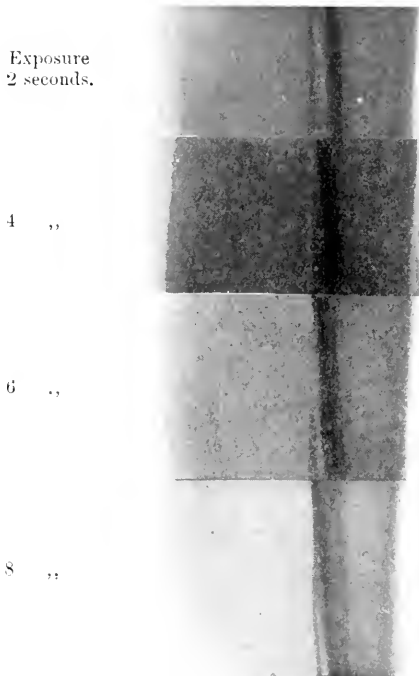

FIG. 88.—To illustrate the latitude of exposure. Exposure with a hard tube.

correct. If the temperature was below 45° the resulting picture showed detail, but little density, indicating that the hydrokinone had not been able to use its influence.

*Fourth Experiment.*—On this occasion variations in exposure were made, the times of exposure being as 1 to 5. The plate exposed for the shorter time was developed at 60° and the other at a low temperature. It was found that the first plate gave the better result.

These experiments indicate that by giving minimum exposures the wear and tear on apparatus and tubes is lessened, and the fogging of plates by secondary radiations avoided, while by proper manipulation of the developing solution better pictures are obtained. A further advantage of using the

developer at a proper temperature is that we lessen the risk of fogging the plate by prolonged exposure to even a "safe ruby" light, and also the risk of chemical fog from prolonged immersion. These points have been elaborated with the intention of showing the advantage of working under proper conditions. It is hoped that they may explain many failures in cases where good results should have been obtained.

### Instructions for glazing Gelatino-Chloride Prints

When the print has been prepared it is necessary to glaze and mount it on a cardboard. Too great stress cannot be put upon this part of the work. A properly glazed and mounted print is the final effort of the radiographer.

*Plate Glass* should be thoroughly cleaned in warm water and soda to remove dirt and grease, and then well rinsed in plain water to remove soda. Polish off carefully with spirits of wine, and soft leather. Sprinkle a little powdered French chalk, and again polish off *lightly* with soft leather.

*Prints* should be previously well hardened in alum or formalin. If alum is used, the solution should be filtered before use, and the print well washed after. If formalin is used, a short washing will suffice.

Place the print direct from washing-water on to the glass, one corner first, allowing the surface to roll into contact; the action of the water will then exclude air bells. Or the print may be placed on the glass entirely under water. Lay the glass on a firm flat table, cover with a piece of clean, smooth blotting-paper, and squeeze lightly with a rubber roller. Heavy pressure should *not* be used, but merely sufficient to remove the surplus water, leaving the print in actual contact with the glass.

*Backing*.—Cut a piece of waterproof backing paper a little smaller than the print. Paste with stiff brush evenly and thinly, and squeeze lightly into contact with the back of the print on the glass. Leave till thoroughly dry. Then insert the point of a knife under the edge of the print, when it will strip off with an enamelled surface.

## STEREOSCOPIC RADIOGRAPHY

A great deal of importance is attached to stereoscopic radiography, many workers going so far as to state that a quick stereoscopic radiograph possesses as much value as a Röntgen cinematographic result. It is certainly most useful in depicting subjects like renal calculi, stomachs, intestines, and fractures, especially of the pelvis and femur; but opinion is very divided as to its value in locating foreign bodies, many workers claiming that better results are obtained by the comparison of two different radiographs taken at a much wider angle. When observing any object or group each eye sees quite a different picture, but the two images thus seen are combined into one picture by the brain, which has the property of perspective. To accurately radiograph stereoscopically, therefore, it is necessary that the points of view should be the same distance apart as the pupils of the two eyes, but in radiography it has been found that to produce the best relief it is necessary to exaggerate the stereoscopic effect. It is necessary, therefore, to take two successive radiographs on two different plates, which are placed in exactly the same position, to keep the patient absolutely stationary, and to shift the tube a few centimetres to either side of the centre. The correct degree of movement for the tube has been calculated by Marie and Ribaut, who have given the following table, but this need not be absolutely followed if the movement of the tube is recorded.

MARIE AND RIBAUT'S TABLE

Thickness of part to be radio- graphed.	Distance of the Anti-cathode to the surface of the Body.			
	20 cm.	30 cm.	40 cm.	50 cm.
cm.	cm.	cm.	cm.	cm.
2	4.4	9.6	16.2	
4	2.4	5.4	8.8	13.5
6	1.7	3.6	6.1	9.3
8	1.4	2.8	4.1	7.3
10	1.2	2.4	4.0	6.0
15		1.8	2.9	4.3
20		1.5	2.4	3.5
25		1.3	2.1	3.0
30		1.2	1.9	2.7

} Distance to which  
the tube must be  
displaced.

The point to bear in mind is that the nearer the object of interest to the plate the greater the distance the tube must be moved between the first and second exposure. After the exposure and subsequent development the two

images must be optically fused into one, and for this purpose there are many forms of stereoscopes, such as the Wheatstone reflecting, prism stereoscope, and the Pirie hand stereoscope. Both pictures can be reduced and viewed in a hand stereoscope.

As to the necessary apparatus for taking stereoscopic radiographs, if only those parts of the body which can be kept stationary without effort are required, and time is not an important factor, then an ordinary stereoscopic plate-holder can be used where the patient lies upon a holder with a top which is transparent to the X-rays. Into this holder place two plate-holders, which can be exchanged without moving the patient. On the other hand, if stereoscopic results of those parts of the body which cannot be controlled voluntarily are required, then an automatic arrangement must be adopted to shift the tube and the plate synchronously and instantaneously (see Fig. 70). There are already several of these devices on the market, but they are daily being improved, and we shall no doubt shortly have a perfect one produced.

Stereoscopic fluoroscopy has also been attempted, but although possible and indeed successful with parts of the body such as the hand and the foot, this has hardly been satisfactory with the thicker parts.



## THE LOCALISATION OF FOREIGN BODIES

The demonstration of a foreign object in any part of the body is one of the most useful functions of the X-ray examination, and its accurate localisation is one of the most difficult duties of the radiographer. Even after a body has been definitely localised, the surgeon may not be able to measure exactly the distances from given points so as to make his incisions and extract the foreign body at once. There are fallacies in the interpretation and miscalculations of distance, and, lastly, it must not be forgotten that if a foreign body is located, the patient must be placed in exactly the same position at the time of operation as he occupied when the radiographs were taken. A slight degree of flexion or rotation of a limb will upset the calculations, and the foreign body may be found to be as much as 1 or 2 inches away from the spot at which it had been localised. It must also be pointed out that if a localisation is to be of its greatest value it should be done immediately before the surgeon operates; if possible it should be done in the operating theatre. Where many cases require investigation a small theatre should be attached to the X-ray department. Of the various methods for localising foreign bodies the most useful and probably the best known is that introduced by Mackenzie Davidson. The details of the method will be dealt with later. Modifications of this method exist, and have been used by many workers. Foreign bodies are met with in all parts of the body, and the localisation will vary in difficulty according to the part in which a foreign body is found. In the limbs they are comparatively easy of localisation, but in the skull, thorax, and abdomen the greatest difficulty may be experienced.

Probably the best all-round method of localisation in the latter regions is the stereoscopic. This is carried out in the same way as in ordinary stereoscopic work. Two plates are necessary, and in most cases it will be found useful to place on the skin of the patient an opaque body which will give a shadow, and may be used as a landmark for subsequent comparison. By employing cross wires the stereoscopic may be used in conjunction with Mackenzie Davidson's method. Stereoscopic plates should be developed together in order to secure, if possible, the same density of negative; similarly the condition of the tube and length of exposure should be the same for each plate. A note should be made of the position of the plate in relation to the body of the patient. This will be found useful when it is necessary to

state the exact position of the foreign body in relation to fixed anatomical landmarks.

Good stereoscopic negatives, when viewed in the stereoscope, show perfect pictures, with the correct perspective for the parts shown, though

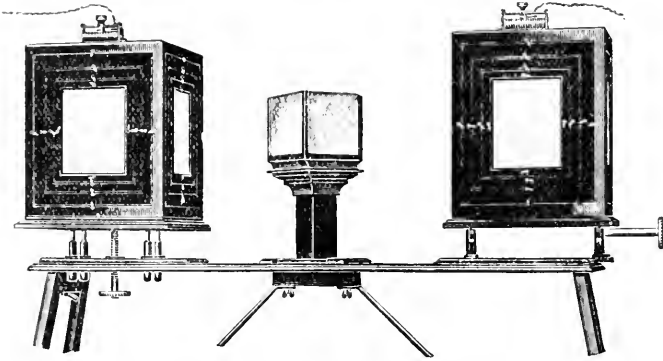

FIG. 89.—Wheatstone stereoscope. (Watson.)

the exact localisation of a foreign body may be difficult or in some instances impossible. A Wheatstone stereoscope should be employed whenever possible, as it affords valuable aid by means of its adjustable parts in quickly getting the correct position of the plates. When this comparatively elaborate stereoscope is not available, a Pirie hand stereoscope will be found useful.

#### Pirie Stereoscope for the Examination of X-Ray Negatives.

—The Pirie stereoscope is arranged on entirely different lines from the instruments which have been heretofore employed for the examination of



FIG. 90.—Pirie stereoscope.

stereoscopic X-ray negatives. Instead of using reflecting mirrors, a double reflecting prism is used. For convenience the prism is mounted in one of two metal tubes, which are bound together by a connecting piece, the second tube being a plain one only, and serving to exclude extraneous objects from view. The stereoscope is light, the metal

part being constructed of aluminium, and can be easily carried in the pocket. A feature of the Pirie stereoscope is the ease with which stereoscopic vision is obtained. It frequently happens that persons who are not accustomed to examining stereoscopic negatives wish to do so, and with the old form of reflecting mirror stereoscope this has always been a difficult matter, very often ending in failure. With the Pirie stereoscope, however, it is almost impossible for anyone to avoid seeing the negatives stereoscopically. The negatives are taken in the usual manner and are placed side by side, either

in suitable boxes provided with electric light, or they can be rested on the framework of a convenient window.

The distance at which the negatives are observed depends upon the distance between the centres of the negatives, that is to say, the size of the plates. For instance, the best position to inspect a pair of 12 inch by 10 inch negatives placed as closely together as possible is about 3 feet 6 inches. When looking at smaller negatives it is necessary to come much closer in order to obtain a comfortable stereoscopic effect, or with larger negatives the distance must be increased.

The negatives should be on a level with the eyes and if possible slightly tilted towards each other.

By concentrating the attention through the plain tube (*i.e.* the one without the prism) and centering the image on the corresponding side, a stereoscopic effect is at once perceived even by those who are unaccustomed to stereoscopic work.

The correct position of the foreign body may be located and a statement made as to its relative position to well-known landmarks, but when operation for removal is contemplated the surgeon should examine the plates on the stereoscope and form a mental picture of the position of the foreign body which should guide him throughout the operation. To facilitate this a stereoscope should be placed in close proximity to the operating theatre.

**Simple Methods of Localisation.**—There are simpler methods for localisation which may be employed in cases which are not likely to require an exact degree of measurement. Foreign bodies in the limbs come under this heading. It is obvious that in some instances one negative is sufficient to indicate the position of the foreign body, though it is surprising how difficult an apparently easy case may become under some circumstances. All operations for removal should be undertaken as soon as possible after the radiograph. More difficult cases require more elaboration, and in all instances of bodies in the limbs two radiographs should be taken: (1) antero-posterior position, (2) lateral position. The limb need not be moved when these exposures are made. A simple plate-holder with a second one at right angles will suffice. The tube alone requires to be moved. An examination of the two negatives should give the position of the foreign body. In the plate taken in position (1), the distance from a given point, probably a bony landmark, is taken. The plate taken in position (2) shows the depth from the surface. In most instances this should be sufficient, as the operator has only to measure the distances and make a mental note of the position.

In order to get a graphic record of the measurements, a simple plate-holder can be constructed with an inch or centimetre rule, which slides over the surface of the plate so that it may be placed in relation to a bone or foreign body. A second inch or centimetre scale runs at right angles to the longitudinal one. The marks on the scale are rendered opaque by inserting pieces of wire into the wood at the correct distances. The second plate-holder is fixed at right angles to the first one and also has sliding scales. The

foreign body may be located by screening prior to the taking of the plates. When the two negatives are examined it is easy to locate accurately the

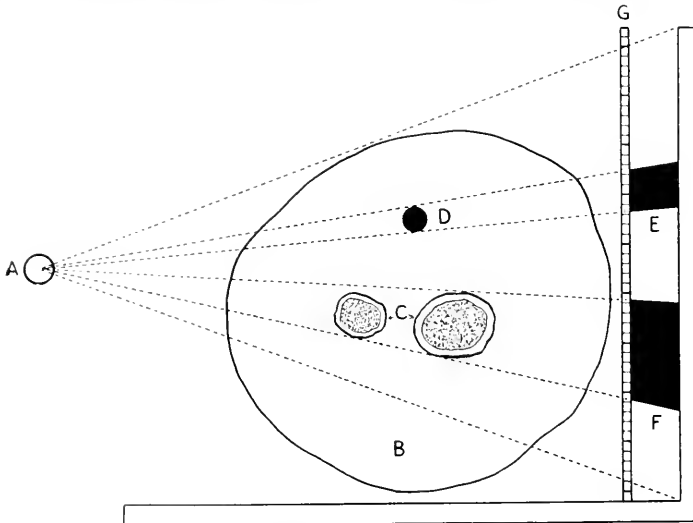

FIG. 91.—Diagram to show method of taking a lateral view.

A, Source of X-rays.  
 B, Foreign body.  
 C, Bones.  
 D, Limb.

E, Shadow of foreign body on plate.  
 F, Shadow of bones.  
 G, Graduated scale.

foreign body. The plates have on the surface an exact rule for measuring. For exact localisation the Mackenzie Davidson method should be employed.

**Method employed in Mackenzie Davidson Localisation.**—The central ray emitted from an X-ray tube has to be definitely found. To do this it is necessary to have an arrangement for determining the central ray. The tube is accurately fixed on the box beneath the table; the latter moves in two directions on trolley wheels. The central ray is located by means of cross wires, or a plumb-line running on pulleys and moving with the tube, so that whatever the position of the tube the plumb-line always indicates the position of the focus of rays upon the anti-cathode. The distance of the anode from the top of the couch is constant, and should be recorded on a convenient place on the couch; the distance of the plate from the top of the couch must also be taken into consideration. The two added together give the distance of the anode from the plate. When working with the tube above the patient, the two positions of the anode are secured by moving the tube along a horizontal bar which is marked with a millimetre scale, running both ways from a central point at zero. The sensitive plate or film is placed underneath, and protected in the usual way by black paper, or it may be placed in a light-tight cassette. Two wires are laid at right angles to each other on the photographic envelope, and so placed that one of them runs in the same direction as the horizontal bar which carries the tube above, and their point of intersection lies beneath zero on the scale. The cross wires may be

fastened to a thin board or sheet of vulcanite, and retained in position over the sensitive plate by drawing-pins, or they may be permanently fixed to a frame, upon which the plate is placed. The marks corresponding to the cross wires should be painted with aniline ink or silver nitrate solution, so as to leave a mark on the body of the patient, and it is convenient to identify one of the corners of the plate by some opaque object, such as a small coin, with a corresponding sign on the adjacent skin surface. Two equidistant points are marked off by clips, or any other method, at each side of zero on the horizontal scale bar, at a distance decided on by the operator. The focus-tube is drawn up to one side-clip, and an exposure made. It is then pushed over to the other clip, and a second exposure made of equal length. The distance from the centre point of the anode to the plate is then accurately measured. Accurate data have now been obtained, from which the operator may calculate the exact relation of a foreign body in the tissues to the aniline cross mark on the patient's skin.

When the tube is operated from below a similar arrangement is used, the tube being first centred over a known point of the part to be radiographed. A scale is attached to a convenient part of the table and the movement to one side (a known distance) is made, say 3 cm.

The tube-box is fixed and the exposure is then made. The plate is removed and a second one placed in exactly the same position. The tube is now moved 6 cm. in the opposite direction to the first movement, and the second exposure is made. It should be noted that the frame with the cross wires and the plates occupies the same position relative to the patient during the two exposures. It is also possible to make the two exposures on one plate by exposing only half at a time, thus enabling a little time to be saved in the subsequent procedures for localisation.

Having obtained the radiographic records the next step is to proceed to the exact localisation of the foreign body. This is done by means of the cross-thread localiser (Mackenzie Davidson). The apparatus consists of an adjustable horizontal bar, which is marked with a millimetre scale starting

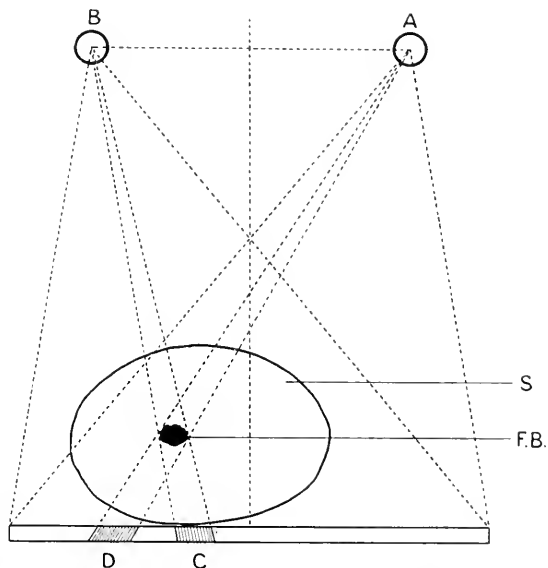

FIG. 92.—Diagram showing Mackenzie Davidson method. (After Walsh.)

- |                             |                                                  |
|-----------------------------|--------------------------------------------------|
| A, First position of tube.  | D, Shadow thrown on plate by tube in A position. |
| B, Second position of tube. | C, shadow thrown on plate by tube in B position. |
| S, Skull or limb.           | F.B., Foreign body.                              |
- Dotted lines represent the paths of the rays.

from a central zero, and is notched to correspond on its upper edge; a plate-glass stage marked with two lines at right angles to each other, the point of intersection lying exactly beneath zero on the horizontal bar. Beneath the stage is a hinged reflecting mirror. The developed negative or tracings of the two plates on a celluloid sheet is placed film upwards on the glass stage, and the shadow of the wires made to correspond with the cross mark on the stage. The bar is next raised or lowered so as to bring the zero of the scale to the same distance from the scale as that of the centre of the anode from the sensitive plate when the exposures were made. Two fine silk threads are next passed over the horizontal scale bar. Each thread has a weight at one end to keep it taut, and is fixed in a notch on the scale corresponding

with the distance of the anode from zero during the original exposure. The other end is threaded into a fine needle fixed in a piece of lead. The path of the thread between the notch on the scale and the eye of the needle represents the path of the X-ray and is movable. A second thread is passed through the notch at the other end of the horizontal bar. It represents the path of the rays during the second exposure after the tube has been moved.

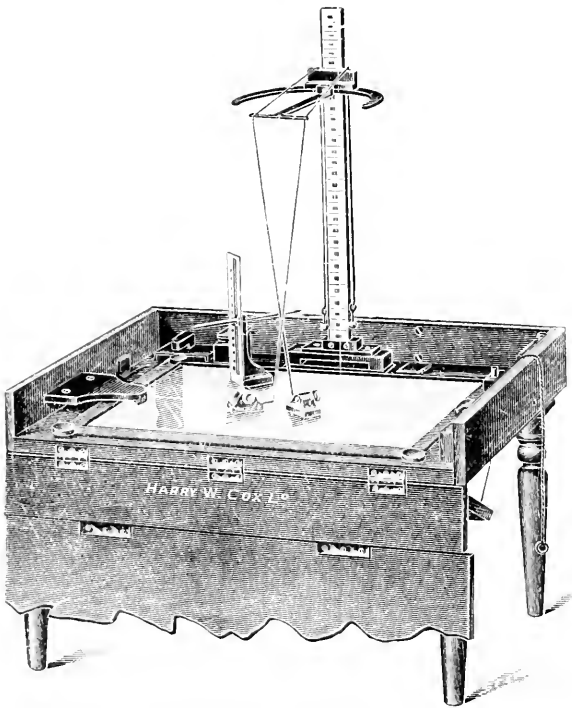

FIG. 93.—Mackenzie Davidson cross-thread localiser. (Cox and Co.).

With two such threads, then, it will be easy to trace the path of the rays in relation to a body interposed between the focus-tube and the sensitive plate. One threaded needle is placed upon any particular part of one of the photographic shadows of the foreign body, and the other needle upon a corresponding part in the second shadow. The point where the threads cross and touch each other will represent the position of the part of the foreign body chosen for location. A perpendicular is then dropped from the intersection of the threads to the negative below, and a mark made where the perpendicular touches the negative. The distance of the spot thus marked out from the cross wires is measured by a pair of compasses. The operator is now in possession of the required measurements. If the distances are 3 cm. and 1 cm., and the depth from the crossing of

the threads to the plate  $2\frac{1}{2}$  cm., then he knows that the foreign body lies at  $2\frac{1}{2}$  cm. from the surface of the patient's skin, at a distance of 3 cm. and 1 cm. from the cross wires, in a quadrant that is easily determined by reference to the distinguishing mark placed there when taking the double-exposure radiograph.

Dawson, Turner, and others have published a simple formula for localising. Two radiographs are taken on one plate by moving the tube a known distance. The distances are measured from tube to plate (A), between the two positions of the tube (B), and between the two shadows on the photographic plate (C). Let  $x$  equal the

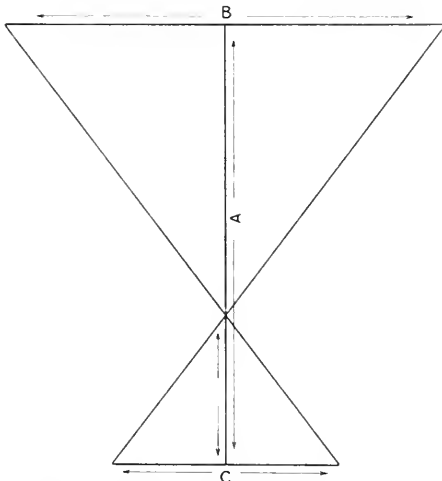

FIG. 94.—Diagram to illustrate simple formula for localising. (After Walsh.)

distance of the foreign body from the plate.

Then

$$x = \frac{a \times c}{b + c}$$

Supposing  $a$  to be 33 cm.,  $b$  10 cm., and  $c$  1 cm., then

$$x = \frac{33 \times 1}{10 + 1} = 3 \text{ cm.}$$

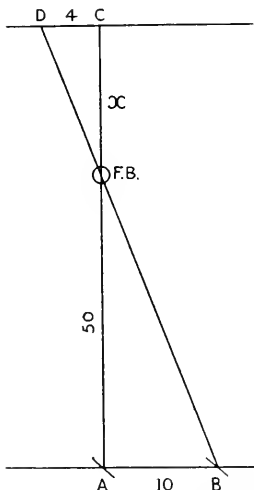

FIG. 95.—To illustrate Mackenzie Davidson's short method of localisation.

$$4 : x :: 10 : 50 - x.$$

*F B*, Foreign body.

*A*, First position of tube.

*B*, Second position of tube.

*C*, Position of image of *F B* in first position. A mark is made on the skin at this spot.

*D*, Shadow of *F B* in second position of tube.

Mackenzie Davidson has suggested a short method of localisation which, while based on his original method, allows of more rapid localisation. The central ray is determined and the position fixed by means of a plumb line. The foreign body is located directly under the point of the plumb line. A mark is made upon the skin, a plate is exposed, the tube is moved a known distance, and a second exposure made. The depth of the body is determined by calculation in the ordinary way. Two cross wires, arranged at right angles, must be used. Dr. Hampson has simplified this method still further by having a graduated scale fixed to the fluorescent screen. By movement at the time of screening he is able to say the depth of the foreign body at a point vertically below the skin mark. This method can only be used at a fixed distance in all cases unless separate scales are worked out for each position of the tube in relation to the screen or plate. The

method is more fully described on p. 114.

**Hampson's Method of Localisation.**—The method introduced by Dr. Hampson is briefly as follows :

Place the patient on the couch and arrange the tube in the tube-box with the focus point at a determinate distance, say 50 cm., beneath the surface

*cm. on Screen*



*cm. Depth: F.B.*

FIG. 96.—Graduated scale in Hampson localiser.

of the screen. Contract the diaphragm opening so as to make it easy to centre the foreign body in the field of view. The rays through it will be practically vertical, and a small arrow head or other metallic mark fixed on the skin will localise the selected point of the foreign body in two dimensions, along and across the trunk or limb. For the estimation of the depth a mark is placed on the glass of the screen over a selected point of the foreign body. Move the tube-box, and with it the focus, a known distance, say 10 cm., and mark on the glass the new situation of the selected point, opening the diaphragm wider if necessary. Measure the distance that the shadow of the point has travelled, read this off on the upper side of the scale, Fig. 96, and the corresponding number on the lower scale will be the depth of the foreign body beneath the screen. If the part of the patient under examination is concave and does not touch the screen, this must be allowed for in stating the depth.

In cases where the distance between the screen and focus point cannot be permanently adjusted, the same result can be obtained with very little trouble and delay. Ascertain by measurement what the distance is, mark the *traverse* of the shadow as before, and then work out the result as follows :

AB, Fig. 96*a*, is a line equal to the vertical height from screen to focus.

AC is the horizontal movement of the focus.

BD is the horizontal movement of the shadow on the screen.

Draw a line DC intersecting AB in E.

Then BE is the depth of the foreign body below the screen.

The correctness of the result depends on the accuracy of the measurements, so these should be made as few as possible in order to reduce the occasions for inaccuracy. It is, therefore, better to measure directly the distance from focus level to screen by means of a large pair of callipers.

Other distances than 50 cm. may be used, but a separate scale must

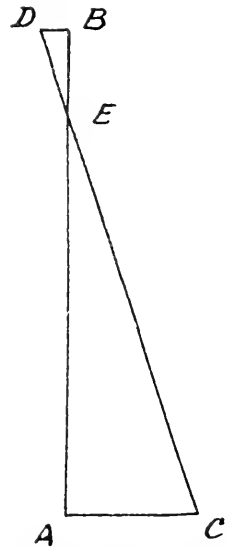

FIG. 96*a*.—Hampson localiser. Diagram to illustrate method.



be prepared for each distance. A table prepared for the 50 cm. interval will be found useful :

$\frac{1}{2}$	cm. traverse on screen	means a depth of	$2\frac{1}{2}$ cm.
1	.. ..	.. ..	$4\frac{1}{2}$ ..
2	.. ..	.. ..	$8\frac{1}{3}$ ..
3	.. ..	.. ..	$11\frac{1}{2}$ ..
4	.. ..	.. ..	$14\frac{1}{3}$ ..

**Shenton's Method of Localisation.**—Shenton relies entirely on the screen method of examination and denounces all radiographic methods. He uses a circular diaphragm of small diameter and centres this accurately under the foreign body. A metallic pointer or probe is now passed between the screen and the limb under investigation, and its tip placed over the shadow of the foreign body, or to be more correct, the shadow of the probe is watched until it coincides with the shadow of the bullet, the probe is held steadily in position, the room is lighted up, and the exact position of the probe point is marked upon the skin surface. This is a point immediately over the bullet, and it is manifest that an incision carried to a correct depth must find the object sought for. It remains therefore to ascertain the exact depth at which this lies. A straight probe is used. Around it is twisted a piece of lead foil or soft wire so as to make an appreciable bulge. Turn the limb upon its side, *i.e.* at right angles to its former position ; then place the tip of the prepared probe on the spot marked upon the skin, letting the probe lie horizontal to it, or in other words, parallel with the screen. Next slide the piece of lead foil along the probe until its distance is equal to that of the point from the bullet or other foreign body. The distance between the point of the probe in contact with the skin and the bulge caused by the lead foil is equal to the distance between the skin surface and the position of the bullet. The distance may be measured upon the probe, and the operator is in a position to say that the bullet lies under the spot already marked upon the skin, and that the depth corresponds to a known distance as measured by the probe and the movable bulge upon it.

Shenton has introduced a localiser which he says is really a depth-gauge. This is a very ingenious and useful apparatus for localising foreign bodies in the limbs.

## Localisation of Foreign Bodies in Special Localities

**Localisation of Foreign Bodies in the Eye and Orbit.**—(a) *Mackenzie Davidson method.* This is a method for exact localisation of a foreign body in the eyeball. A special adjustable head-piece, fixed to a chair, is employed. It usually consists of a horizontal arm, carrying an open rectangular framework, across which two wires, one vertical and the other horizontal, are stretched, and against which the photographic plate is placed. Attached to the framework is a small rifle "sight," at the same level as the intersection of the cross wires, the use of which will be presently

described, while below and to one side is a chin-rest, so that the patient does not move his head while the plates are changed and the exposures made. Parallel to the arm carrying the open framework is another arm, bearing a sliding clamp for the X-ray tube. In this way the tube always moves parallel to the horizontal cross wire. The tube is first arranged with the glistening point of origin of the X-rays on the anode exactly opposite the intersection of the cross wire, this being done by arranging the rifle "sight," the point of intersection of the wires, and the point on the anode, all in the same straight line. The distance between the point on the anode and the intersection of the wires, usually about 35 cm., is carefully measured. The patient now sits in the chair, with his head between the two horizontal arms, and with his chin placed on the chin-rest, places the side of his head (injured eye side) against the cross wires, so that they are between his head and the photographic plate, and looks straight forward, as if at a distant object, so that the visual axis of his eye is parallel to the horizontal cross wire. A piece of lead wire, exactly 1 cm. long, is fixed to the lower eyelid of his injured eye by adhesive plaster, and the distance between the upper end of the wire and the centre of the cornea in this position noted. The tube is now moved 3 cm. to one side of its original position and an exposure made. Another plate is put in position, and the tube slid 6 cm. in the opposite direction, and another exposure made without the patient moving his head. The two plates are developed and fixed in the usual manner. The head-piece is usually made with the cross wire framework and tube-holder fitting on both arms, so that either eye can be radiographed.

The shadows of the foreign body, if there is one, on the negatives have now to be localised, and for this purpose the cross-thread localiser is used. This is simply an apparatus for placing the negatives in exactly the same geometric conditions under which they have been made, and it has been fully described on page 112.

With these means we can now reconstruct the exact conditions under which the two skiagrams were taken. The horizontal bar is arranged so as to be at the same distance from the plate-glass as the point on the anode was from the cross wires. The two threads passing through the two notches 3 cm. to each side of the central point of the bar will, therefore, represent the paths of the X-rays when the exposures were made.

A thin piece of varnished celluloid, also having cross lines scratched on it, is placed against the film side of the negative, so that the cross lines correspond in both, and the position of the foreign body is marked by pen or pencil on the varnished celluloid, as well as the shadow of the lead wire on the lower eyelid. The same is done with the other negative using the same piece of celluloid. In this way we get two shadows of the foreign body and of the lead wire in their relation to one outline of the cross wires. The celluloid with these markings is now placed on the plate-glass, with the cross lines corresponding in both. The ends of the cross threads attached to the weighted needles are placed on the markings of the foreign body in such a way that the shadow of the foreign body to the right is at the end of the thread passing

through the notch on the left, and *vice versa*. These threads representing the paths of the X-rays in the two exposures, the points where they cross will represent the point in space of the foreign body.

To localise the point one has to measure the perpendicular distance of the intersection of the threads from three planes at right angles to each other. The vertical distance of the point of intersection from the celluloid is measured by a pair of compasses, and this distance represents the depth of the foreign body from the skin, as the side of the head was against the cross wires. Next, the distances between the two vertical planes represented by each of the cross lines, and the point of intersection, are measured. To do this an upright square is placed with its edge coincident with one of the cross lines, and the perpendicular distance is measured by compasses. The same is also done with respect to the plane of the other cross line. These measurements determine a point on the skin at the side of the head directly beneath which the foreign body lies, provided we know the relation of the cross wires to the patient's skin. If the foreign body is of any size it is necessary to determine the exact location of each end of its shadow, but if it is very small one measurement is sufficient.

As the location of a foreign body as being at such and such a depth from the skin of the temple would not give the surgeon much practical help, one must be able to state its relation to the part of the eyeball. It was for this reason that the lead wire was placed on the lower eyelid. The location of the upper end of the lead wire is determined in relation to the three planes exactly as the foreign body was, and after this it is merely a matter of addition or subtraction to be able to tell how many centimetres the foreign body lies behind, at a higher or a lower level than, and to which side of, the upper end of the wire. We already know the distance between the upper end of the lead wire and the centre of the screen, and as the wire is usually at the same level as a vertical line from the front of the screen, we can give the surgeon a definite point at which the foreign body is lying in relation to the centre of the cornea, so many centimetres behind parallel to the visual axis, so many horizontally to the nasal or temporal side, and so many above or below it. For example, suppose we have found the position of the intersection of the cross threads marking the foreign body (*b*) to be 1.9 cm. above the celluloid, 3 cm. behind the plane of the vertical cross line (B), and 1 cm. below the plane of the horizontal cross line (A), and the intersection of the thread working the upper end of the lead wire (*a*) to be 2.9 cm. above the celluloid, 1.2 cm. behind the plane of the vertical line (B), and .6 cm. below the plane of the horizontal line (A), then by subtraction the foreign body is 1 cm. to the temporal side, 1.8 cm. behind and .4 cm. below the upper end of the lead wire, and as the latter is .5 cm. below the centre of the cornea, we are able to say that the foreign body lies 1.8 cm. behind, 1 cm. to the temporal side, and .9 cm. below the centre of the cornea, with the eye looking at a distant object.

Lastly, it should be remembered that the skiagrams taken in this way are stereoscopic, and if so viewed will give a stereoscopic effect; and as

the lead wire is of the known length of 1 cm., it may be used stereoscopically as to scale to estimate approximately the size and position of the foreign body.

(b) *Sweet's Method of Localisation.*—Dr. Sweet's method of localising foreign bodies in the eye and orbit is carried out by means of the special apparatus designed by him for the purpose. The illustration on page 124 shows the device, which comprises a head-rest for securing the head of the patient above a plate-holder, so that plates can be changed and one-half exposed without disturbing the patient. The pneumatic cushion shown is placed between the patient's head and the plate-holder.

In use, the patient's head is placed in position and the indicator shown on the right-hand side is placed in exact alignment with the centre of the cornea. The indicator is then pushed gently up to the eye itself, and when just touching it is released and carried back by a spring exactly 10 millimetres. Two exposures are made, the first with the anti-cathode of the X-ray tube in the same plane as the plate, and with one-half of the plate covered. The unexposed half of the plate is then brought into position, and a second exposure made with the tube slightly tilted. After development the positions of the foreign body and of the indicator are plotted upon a special chart sheet, a number of which are supplied with every instrument. It should be noted that it is not necessary to place the tube at any known distance from the plate, or move the tube an exact distance for the second exposure. The special charts prepared on squared paper show exactly the relative position of the indicator and foreign body.

(c) *Stereoscopic Method.*—This is a most useful method, and should always be employed, even when an exact localisation by other methods has been carried out. It is necessary to take the radiographs in two positions: (1) Lateral, and (2) antero-posterior. When these radiographs are examined little doubt should exist as to the size and position of the foreign body, provided the operator knows the position of the plates when the radiographs correspond.

When used in combination with Mackenzie Davidson's method it is the most accurate of all.

(d) *Simpler methods* may be employed. Two positions are necessary: (1) Lateral, (2) antero-posterior. Two pictures of the foreign body are obtained on one plate by making the first exposure with the eye looking upwards, the second with the eye looking downwards. Movement indicates the position of the body in relation to the eyeball. An antero-posterior plate should also help to locate the position of the foreign body. This method is necessarily inaccurate, and can only be used to determine the presence of a foreign body. Should operation be necessary, then an exact localisation by the Mackenzie Davidson method must be carried out. In regions of the body, such as the thorax and abdomen, the same measures may be employed. Stereoscopic radiograms of the thorax in the antero-posterior and lateral positions should suffice to indicate the position of the foreign body. The cross-thread method of localisation should be employed as a confirmatory measure.

**Localisation of Foreign Bodies in the Skull.**—The methods

available are (a) stereoscopic; (b) stereoscopic combined with Mackenzie Davidson method.

A simple method may be employed when it is not possible to have access to the two methods referred to. It is one which anyone possessing an X-ray installation can carry out, and which has proved useful in many instances. Three plates are required: (1) Right lateral, (2) left lateral, (3) antero-posterior. For the localising of foreign bodies in the head the skull is divided into sections by means of flexible wire. A piece of wire is fixed in the longitudinal diameter, extending from the nasion in front to the external occipital protuberance behind. A second wire is carried from the nasion through the centre of the external auditory meatus backwards to end

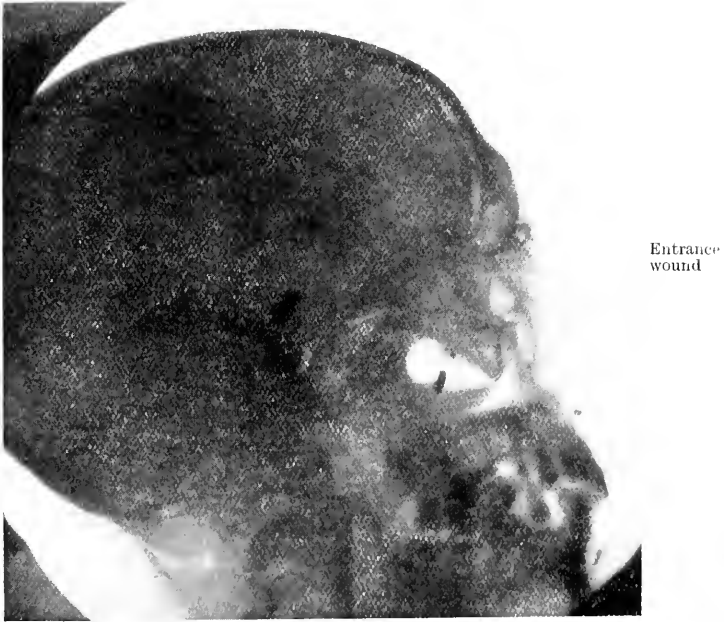

FIG. 97.—Bullet in brain. Fragments in face.

below the occipital protuberance. A third wire is carried vertically over the skull from one external auditory meatus to the other. Three plates are taken and compared. When the foreign body is sharper on one plate than on the others it indicates that it is nearer to the side on which it is sharpest. The antero-posterior plate confirms this observation. The lateral pictures also serve to show the relationship of the foreign body to a well-known landmark at the base of the skull.

#### **Localisation of Foreign Bodies in Region of Hip and Shoulder.**

—In these regions it is impossible to get more than one position, so stereoscopic radiographs should be taken. These combined with the Mackenzie Davidson method give the most accurate results.

**Localisation of Foreign Bodies in the Limbs.**—In a number of instances it may be possible to locate the foreign body by screening alone.

In other instances one of the methods described by Mackenzie Davidson, Hampson, Shenton, and others may be used. The position of the foreign body is ascertained and a mark placed on the skin surface immediately



FIG. 98.—Fracture of lower jaw ; foreign body in soft parts ; a portion of shrapnel above the jaw bone.

over it. The tube is then moved and the second position of the foreign body noted. It is then a matter of calculation to estimate the depth of the foreign body. Hampson does so by means of the graduated scale, Shenton by the use of the probe with a bulging point on it, and by placing the limb at right angles to the position it occupied when the mark was placed over the foreign body.



FIG. 99.—Fragment of shell in region of hip-joint.

#### Localisation of Foreign Bodies in Deep Parts of the Body.

—In several of these regions the localisation of a foreign body is a matter of extreme difficulty, notably in the thorax abdomen, pelvis, axilla and region of the hip. The exact position may be

marked out both stereoscopically and by the Mackenzie Davidson method, and yet the necessity of avoiding anatomical structures may render the subsequent removal difficult. In some cases it may be helpful to take a lateral view of the thorax or

spine. This may enable us to say at once where the foreign body lies

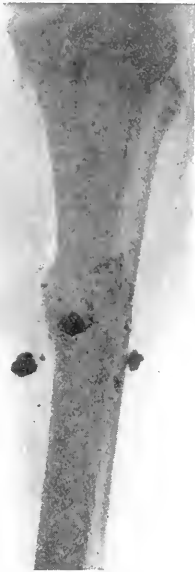

FIG. 100.—Fracture of tibia, portions of shell in limb.

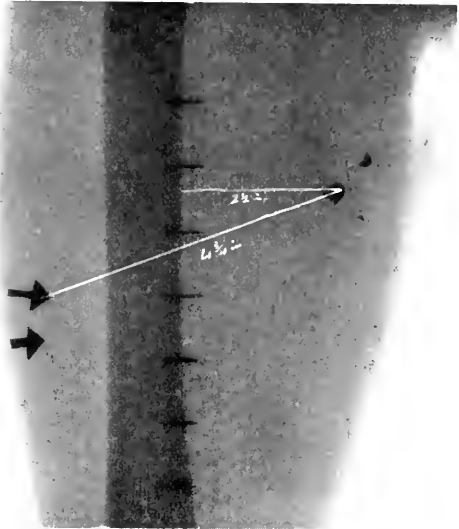

FIG. 101.—Fragments of bullet in limb; arrows indicate position of wounds. Graduated scale over bone. Horizontal line indicates distance from edge of bone, oblique line distance from upper arrow.

in relation to a bony landmark, but for exact localisation it is necessary to use the cross thread method. It has been suggested that X-ray localisation in several cases has complicated the removal rather than been helpful. In order to obviate such complications the following method might be adopted.

The foreign body should be accurately located by the Davidson method and stereoscopic plates taken. The exact spot is marked out and the plates viewed in the stereoscope. These two give the exact spot where the body lies. For removal the following procedure is suggested.

In the operating theatre or the X-ray room a simple table is converted into a combined X-ray and operating-table by using one of the simpler tube-stands which allows of a tube-carrier being placed under the table, a second arm carrying the fluorescent screen. The latter has



FIG. 102.—Fragments of shrapnel in hand.

attached to it a small scale with moving points, such as the Hampson, or one made by Watson and Sons. The tube is accurately centred and the distance between the anti-cathode and the screen ascertained. The patient is prepared for operation and placed on the table. The body is then located on the screen, the skin being marked by a small incision at a point corresponding to the shadow. The foreign body lies just under this spot. The depth is ascertained by a displacement

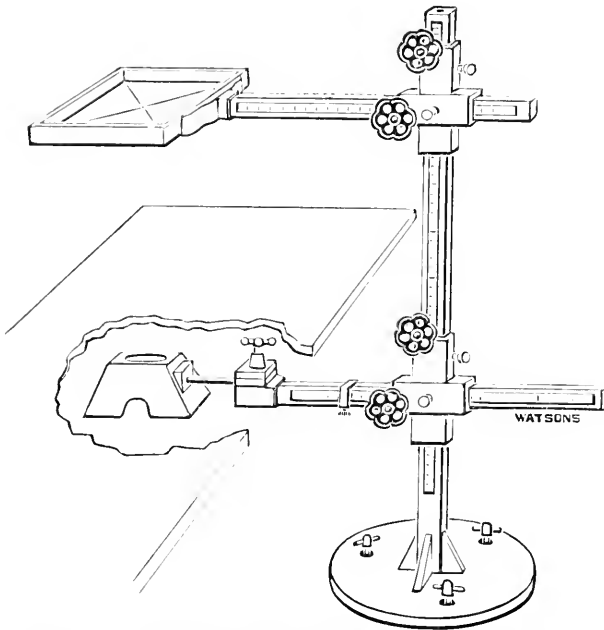

FIG. 103.—Arrangement of X-ray tube and fluorescent screen for accurate localisation by screen or plate.

of the tube a known distance, the scale on the screen automatically recording the depth in centimetres. This reading should be compared with the result obtained by the Mackenzie Davidson method, and if they correspond the surgeon has an accurate statement of the depth of the foreign body. If owing to the anatomical structures interposed on the line of the body it is not possible to cut straight down into it, it can in nearly every case be

found by probing. Should the surgeon fail to find the body quickly, aimless probing should not be continued. The light of the room should be excluded, the X-ray tube turned on, and the surgeon will at once be able to see how far his instrument is from the foreign body and guide his forceps to it.

The length of time the operator is exposed to the rays need not be more than a few seconds, but if many cases daily require to be screened, some method of protection must be employed. By cutting down the diaphragm so that only a small pencil of rays emerge and using long-handled instruments there should be very little risk to the operator.



## RADIOGRAPHY OF THE NORMAL BONES AND JOINTS

A thorough acquaintance with the normal appearance of these parts is necessary on the part of the radiographer before he proceeds to an interpretation of the many variations which he may be called upon to describe. Not only must he know the chief bones and joints from any one aspect, but he should by a careful study of the parts know them from any point of view. It may not be always possible to get the patient into the position of ease which is generally the one in which the parts can be radiographed most readily. A patient suffering from an injury to a joint may not always be able to take up a position on the X-ray table which will enable the operator to radiograph the part to the best advantage; the apparatus may have to be adapted to the patient instead of the patient to the apparatus, hence it is necessary that the operator should be familiar with the parts from several points of view. In ordinary cases of fracture of the bones in the vicinity of a joint it is always a good rule to radiograph the parts in at least two positions.

### The Skull and Accessory Sinuses

There are several positions of the skull which lend themselves to the production of good radiographs. Of these the lateral is the most useful, as it gives a general impression of the whole skull and soft parts, the articulations at the base, and a lateral view of the cervical vertebrae. There are various modifications of this position, to be considered in detail later, which are extremely useful when special areas require to be investigated. To get good radiographs of the skull, it is essential that the head should lie flat on one side, and be held absolutely still during the exposure. A useful instrument for fixing the skull is that supplied with the Sweet localiser, since it may be used in all positions of the skull. It has two or more clamps attached to a base, upon which the plate may be placed. These clamps keep the head in the same position while several radiographs are produced.

Among the numerous pieces of apparatus which can be used for the radiography of the skull, there may be noted a simple chair, devised by Dr. Martin Berry, which promises to answer all the requirements of the radiographer. This apparatus has a movable back, with a circular hole in it. The movement is in the vertical direction, to adapt the central hole to the varying length of the patient when seated in the chair. Side clamps fix the head after the necessary angle has been determined. This angle is obtained by a rod moving along the quadrant of a circle. The head

is placed to correspond with the angle on the apparatus, the plate being placed always at the same angle in relation to the tube. An efficiently protected tube-box is placed on the back of the chair. It can be accurately centred, and has both vertical and transverse movements to facilitate rapid adjustment behind the part to be radiographed. The tube always occupies the same relationship to the plate, the head being tilted to the required angle. To obtain a picture of the two sphenoidal sinuses side by side, a plate is placed under the chin and the tube over the vortex at right angles to the plate. A film placed in the mouth well backwards under the head and soft palate will give a similar picture. Or the patient may lie on a couch with the plate underneath and a compressor extension tube brought down on to the head; this serves the double purpose of fixing the head and cutting off secondary radiations from the tube. The principle of the compressor tube has been already dis-

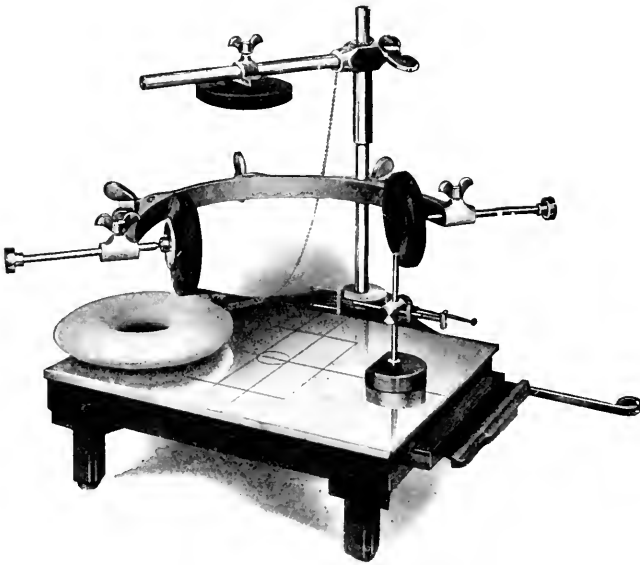

FIG. 104.—Sweet localiser.

cussed. Care must be taken to see that the long axis of the tube is parallel with the plate, and that the anti-cathode of the tube is accurately centred in the tube-box before the tube is brought into position. For general purposes a central position of the tube is all that is necessary, the anti-cathode being over the centre of the plate, and the base line of the skull corresponding as nearly as possible with the centre line of the plate in its longest diameter.

The base line of the skull can readily be determined by a method elaborated by Dr. R. W. A. Salmon and the author. A point is taken on the front of the face corresponding to the nasion, and a line is drawn from this point backwards through the external auditory meatus to the occipital bone, ending in the vicinity of the external occipital protuberance. From this line as a base, other lines may be drawn perpendicularly upwards at stated

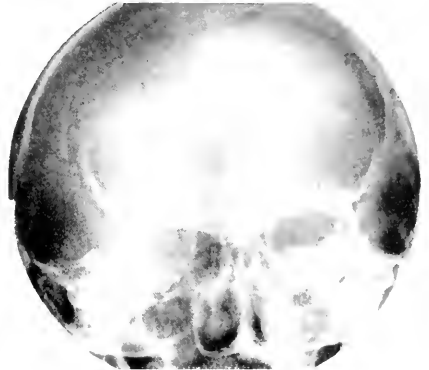
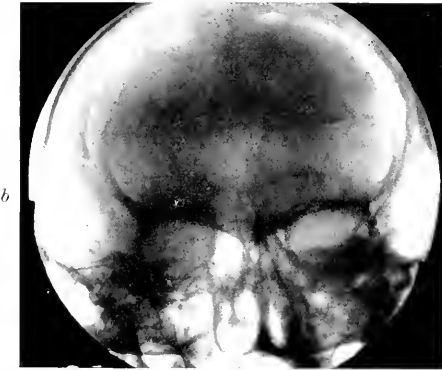

PLATE I.—NORMAL SKULLS.

*a*, Lateral view of normal skull, showing frontal sinuses, sphenoidal sinuses, sella turcica, temporal bones, cervical vertebrae, and lower jaw.

*b*, Antero-posterior view of adult skull, showing frontal sinuses, orbits, nasal fossa, antra, etc. Frontal sinus on left side is opaque.

*c*, Lateral view of skull to show the sella turcica, articulation of spine to skull: the temporo-maxillary articulation on one side is well seen.



intervals, and the skull divided into three or more sections, these perpendicular lines being utilised as central points for the radiography of particular areas of the skull and face. The most useful lines are those drawn at the half and third distances, or the whole line may be divided into thirds or quarters. It is hardly necessary in a work of this kind to describe variations of this base line, but for practical purposes several useful methods of localisation of areas of the skull will be described. For the examination of the mastoid

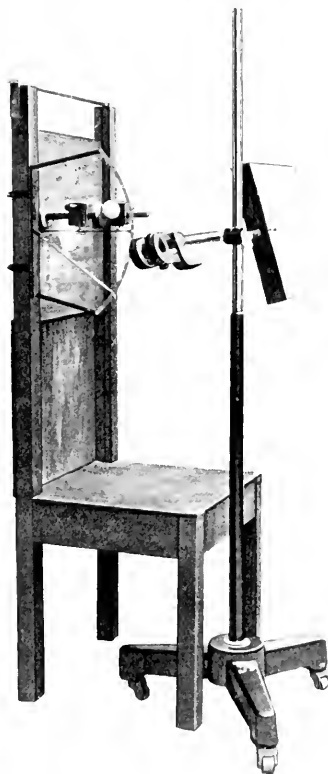

FIG. 105.—Dr. M. Berry's chair for frontal sinuses, etc.

region a good technique has been described by Dr. Howard Pirie. The following is the technique he recommends :

**TECHNIQUE.**—The patient should lie prone on a firm couch. The head is supported on an inclined plane, making an angle of 25 degrees with the plane of the couch, as shown in Fig. 106. The photographic plate rests on this inclined plane. The head is rotated 90 degrees so that the patient looks directly to his side ; this brings the mastoid into contact with the plate. The pinna of the ear is turned forward, so as to obscure the mastoid as little as possible. The source of X-rays is placed vertically above the head, and the perpendicular ray is made to fall on a point 2 inches above the highest point of the pinna. The mastoid on each side must be skiagraphed separately.

The glass of the focus tube should be 9 inches away from the hair. The exposure required will turn a Sabouraud pastille placed at 2 centimetres from the glass to one-third of the B tint. A medium hard focus tube (1.5 Benoist),

with 30 milliamperes for fifteen seconds from a Snook apparatus, gives a plate which should be fully developed in seven minutes (Ilford plate and developer).

Skiagraphs of both right and left mastoids must be made of every case, as a single skiagraph of one mastoid is of little value. A different focus tube should be used for each mastoid, as it is rarely possible to get one tube to remain constant in vacuum for both exposures. Both focus tubes must, of course, be of the same hardness. This is one of the most important points in the technique—viz., to have two similar tubes of equal hardness and quality. The American-made tubes lend themselves to this better than any others I have used.

Having secured radiographs of both right and left mastoids, one should place them side by side in a viewing-box, and note any differences. The radiograph should show :

1. The articulation of the lower jaw, and the posterior border of the ascending ramus of the jaw.

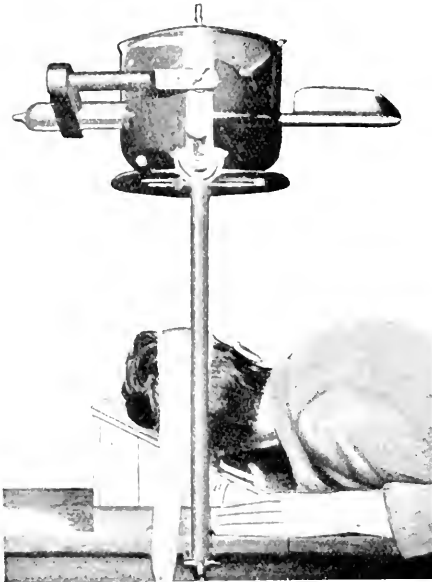

FIG. 105.—Position for radiography of the mastoid sinuses. (Pirie.)

2. The auditory canal, placed behind the articulation of the lower jaw, and separated from it by about one-quarter of an inch.

3. The air cells, which form a reticulum extending from the articulation of the jaw backwards. The cells usually appear larger in the lower part, and smaller above. Sometimes they extend forwards above the articulation of the jaw into the base of the zygoma. It should be remembered that the cells extend well behind the limit of the mastoid process.

4. The petrous bone surrounding the auditory canal, appearing as a dense area superimposed on the mastoid cells.

5. The outline of the lateral sinus should be faintly indicated running through the posterior half of the cells.

6. The foramen magnum, appearing as an elliptical opening with part of the first vertebra crossing it.

7. The outline of the pinna of the ear.

*Acute mastoiditis* shows the following departures from the above description :

1. The air cells are obscured, but can still be faintly seen.
2. The outline of the lateral sinus may be a little more defined than normally.
3. The petrous bone is denser.
4. The whole mastoid region is denser.

When one gets an absolutely normal mastoid on one side, and the other side presents the appearance just described, together with certain clinical signs and symptoms, one is justified in diagnosing acute mastoiditis.

*Chronic mastoiditis* is very typical in a skiagraph. It presents the following departures from the normal :

1. The air cells are completely absent.
2. The petrous bone stands out as a very dense, roughly triangular area, with its apex pointing upwards and backwards.
3. The posterior border of the petrous bone forms part of a sharp crescent-

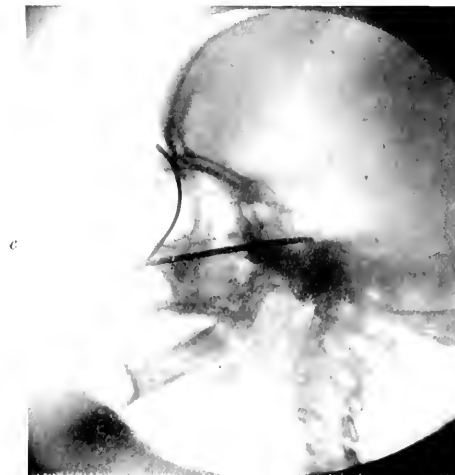

PLATE II.—NORMAL SKULLS.

- a.* Skull of child, plate on anterior aspect showing nasal fossae ; teeth well shown ; there are several unerupted teeth seen.
- b.* Mid area of skull ; a line has been placed on points giving the radiographic base-line ; the line runs through the base of the sella turcica (dry skull).
- c.* Lateral view of skull in living subject ; probes have been placed in the frontal and sphenoidal sinuses.





shaped line. This crescent-shaped line corresponds with the upper and anterior border of the lateral sinus.

4. The lateral sinus is frequently very well shown.

**(1) Radiography of the Sella Turcica.**—A useful method for the radiography of the sella turcica has been described by Dr. Finzi. The patient is placed upon the couch and the tube centred from below. To determine the exact position two small coins are placed one in each ear. After these are superimposed under the screen, the tube is then moved upwards and forwards 1 inch in each direction, and the radiograph taken. A perfect picture of the area required should be obtained.

When radiographing particular areas of the skull, the diaphragm should be shut down to the smallest possible size, or if the tube is used overhead a small extension tube should be inserted between the tube and the patient. Pictures obtained in this way will be found to give much finer detail than those taken with a wide diaphragm. It is important to note that in radiographs of the skull as much detail as can be obtained is desirable.

**(2) The Examination of the Frontal Air Sinuses.**—Two methods may be employed: (*a*) a lateral view of the skull, showing the air sinuses in profile; (*b*) antero-posterior, the plate on the front of the skull and the tube behind.

A direct antero-posterior view does not show the sinuses at all well, the overlapping of the shadow caused by the occipital and temporal bones obscuring the detail in the frontal and accessory sinuses. There are two routes by which the rays may be passed through the back of the skull. (1) The tube may be centred below the bony mass formed by the occipital protuberance: we still have to traverse the thick parts of the base of the skull. (2) A better method is to place the patient face downwards on the photographic plate, the latter being placed at an angle of 25 degrees. The tube is centred well in front of the occipital protuberance, and an oblique though somewhat distorted view is obtained which

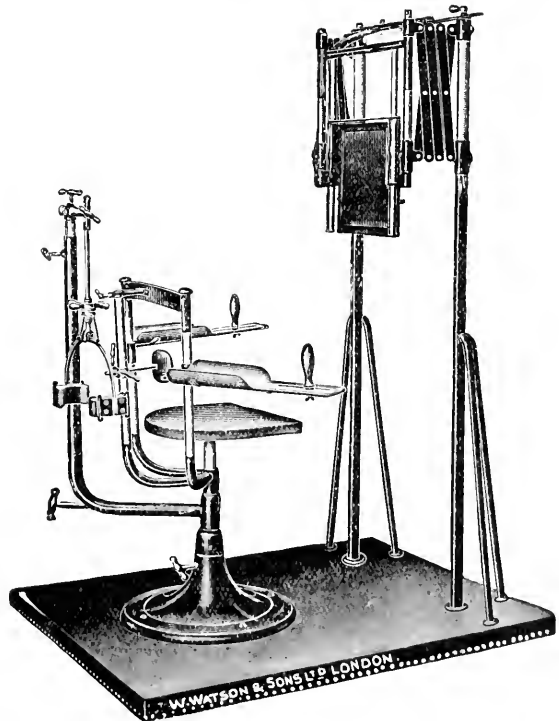

FIG. 107.—Chair for cranial radiography.

Combined chair with clamps for fixation of the head and an adaptable plate-holder.

shows the frontal air sinuses well. Plate I., showing frontal air sinuses, taken by this method, illustrates the points to be examined.

(3) For the Examination of the Sphenoidal Sinuses, the Ethmoidal Sinuses, and the Turbinate Bones, a plate is fixed on the front of the face, and the tube centred just a little below the occipital protuberance. This position should also show the bones of the face and the maxillary antrum. The teeth are also well demonstrated. The condyles of the jaw and the anterior view of the temporo-maxillary articulation are also seen, while behind and a little external is the mastoid process, with its air cells clearly shown.

Plate I., representing a normal skull taken in the lateral position, shows

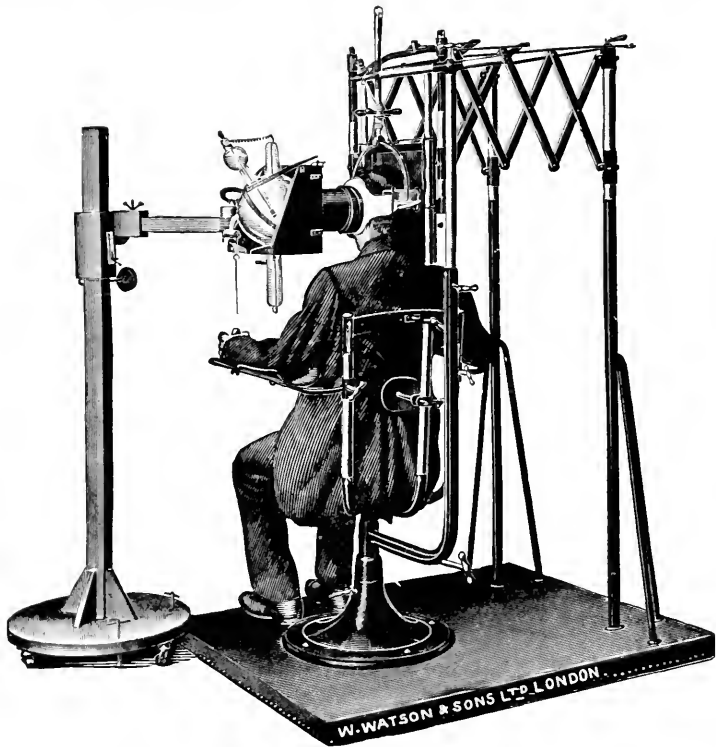

FIG. 108.—Chair for cranial radiography.

all the important structures at the base of the skull ; the three levels are well shown, and the various air sinuses are distinctly seen, notably the frontal air sinuses. Taking the bones of the skull from before backwards, one sees the orbital plate of the frontal bone, the anterior clinoid process, the sella turcica, the posterior clinoid process standing well in relief ; extending backwards, the petrous portion of the temporal bone appears as a denser irregular shadow ; and, immediately behind, the mastoid air cells are prominently shown. Then, at the posterior portion, the well-marked depression formed by the occipital bone is shown. The thickness of the bony wall of the section of the skull shows the two layers of bone with the cancellous bone between them.

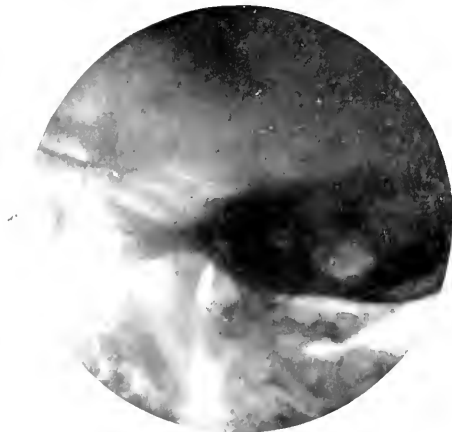
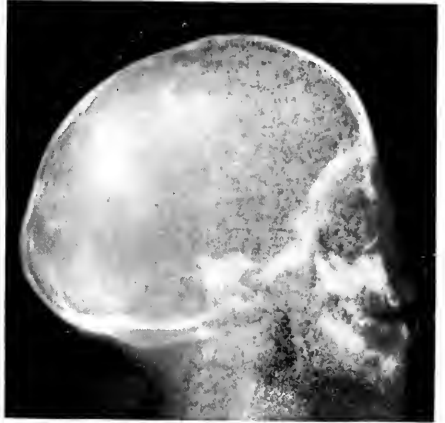
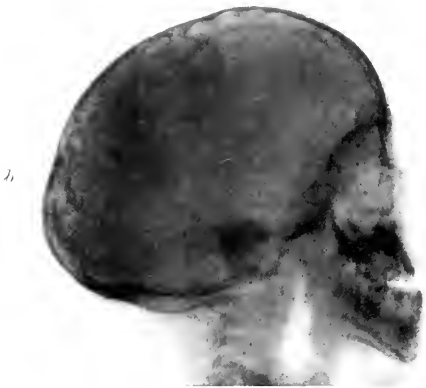
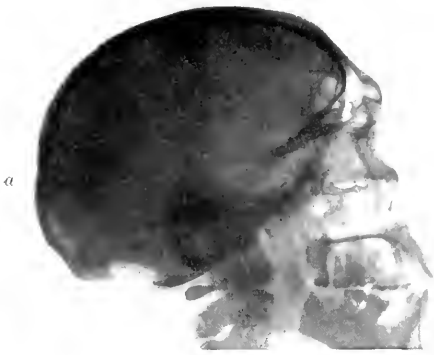

PLATE III.—SKULLS SHOWING DEPARTURES FROM THE NORMAL.

*a*, Lateral view of skull, showing erosion of occipital bone the result of injury with secondary disease of bone. Note large frontal sinuses.

*b*, Skull in a child, showing moulting of the cranial bones resulting from intracranial pressure.

*c*, Skull from a case of tumour of the brain, situated at the sella turcica; the detail in the region is lost.

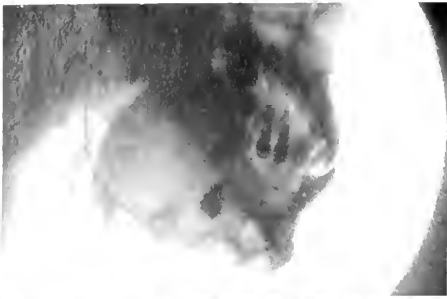

PLATE IV. LOWER JAW AND CERVICAL REGION.

- a.* Dentigerous cyst in lower jaw (buried tooth).
- b.* Fracture through ramus of lower jaw.
- c.* Skull showing good detail in soft parts, absence of teeth, calcified cervical glands.
- d.* Bismuth food in stricture at upper end of esophagus.

In the region of the neck the cervical vertebræ are shown in profile, the styloid process extending downwards and forwards between the cervical vertebræ and the descending ramus of the lower jaw. The zygomatic arch is seen extending forwards on the lateral aspect of the face. The superior maxilla gives an irregular shadow and the anterior shows a clear space, the nasal bones are faintly outlined in profile, and the lower jaw is also shown in its lateral aspect.

**(4) The Lower Jaw** is an important bone, and rather difficult to demonstrate satisfactorily. It may be shown by two methods: (*a*) showing the whole of the bone in a skiagram of the face; (*b*) portions of the bone may be demonstrated by placing a film inside the mouth against the part of the bone it is necessary to show, and using the focus tube outside. The picture then obtained is a small one, but quite large enough to show a fracture, an abscess, or disease or damage to a tooth and its socket. The temporo-maxillary articulation of either side can be satisfactorily shown by centering the tube behind and a little below the angle of the jaw on the more distant aspect from the plate.

Plate I., Fig. *b* shows the chief bony points of the skull and face taken from the antero-posterior position. The plate was placed on the face, with the focus tube behind. The orbits are well marked, and the nasal cavities show a considerable amount of detail, which is of great value when one has to consider the possibility of fracture in these regions. The antrum of Highmore is clearly defined, the zygomatic arch stands out prominently, the lower jaw is thrown out in relief, and behind there is a distinct picture of the mastoid portion of the temporal bone with the air cells.

Plate I., Fig. *c* shows a small and more distinct view of the central portion of the bony parts of the skull. The points to observe are the levels of the bone of the skull in relation to the exterior, the clinoid processes with the sella turcica between, the relation of the chief sutures to the various levels, and the well-marked grooves in the inner table of the skull for blood-vessels. A clearly defined shadow is thrown by the pituitary body situated in the sella turcica. The cervical vertebræ in relation to the bone of the skull show up well. The condyle of the lower jaw, situated in its articular cavity, is also evident, and a fairly good idea of the general contour of the latter.

**(5) The Examination of the Mouth, and especially the Teeth,** is one which calls for special attention. The general outline can be obtained by plates placed on the exterior, the tube being angled to prevent overlapping of the shadows produced by the two sides. Better results can be obtained when films are placed in the interior of the mouth against the area required, the tube being centred over the film from the outside. A suitable mouth gag may be used; this possesses the great advantage of preventing movements during the exposure; a piece of cork or a towel rolled up tight is also very efficacious when other appliances are not at hand.

Special appliances have been devised for the retention of the film in the mouth. A suitably-shaped cork is provided with a slot, into which various rectangular plates of metal are slipped. These metal plates are soft, and can

be bent into any curve to suit the contour of the mouth, and thus secure a close contact. The films are wrapped up in paper as usual, with a small loop of paper left at the back, which is slipped over the metal plate, so that any curve to which the plate is bent also carries the film with it.

The cork is gripped in the mouth by the patient, it being obvious that this method enables the film to be held in any position inside the mouth without any further device or support.

### The Cervical Region

The best positions in which to radiograph this area are : (1) The antero-



FIG. 109.—Upper cervical region, antero-posterior view.

Taken with plate behind and an extension tube in front of the open mouth.

posterior, and (2) the lateral. The antero-posterior is comparatively easy in the lower two-thirds. When the patient is placed with the posterior aspect on the plate and the tube centred over the middle of the plate, a view is obtained of the whole of the cervical vertebræ and the upper dorsal, the apices of the lungs coming into the picture, as do also the sternal ends of the clavicles and the manubrium sterni. The upper cervical vertebræ are obscured by the basi occiput and the lower maxilla.

Should it be necessary to obtain an impression of the first three cervical vertebræ, other methods must be adopted. The base of the occiput and the

first and second cervical vertebræ may be examined by placing a plate on the posterior aspect; and by using a small extension tube, with the mouth opened to its widest extent, a good radiograph may be obtained which should show the condyles of the occipital bone, the odontoid process of the axis, the atlas, and the third cervical vertebra.

The lateral view of the cervical area shows the whole region from the occiput down to the upper dorsal vertebræ. This is a good method for ascertaining the condition of the bodies of the cervical vertebræ, the integrity of the spinal canal, and the presence of abnormalities of the region. The presence of cervical ribs can best be shown by the antero-posterior position.

The cervical region has been partially shown in Fig. 109, but it is necessary to illustrate this particular region fully, for it is here that the difficulty of showing a fracture or dislocation may be very great, and in some instances impossible.

An antero-posterior view of the neck region is not a very satisfactory one, because of the superimposing of the occipital region and the lower jaw. In cases where it is desirable to show the atlas and axis, and the articulation between the former and the occipital bone, it is necessary to take the skiagram through the open mouth, as described in detail above. The resulting picture is necessarily small, but large enough to include the parts desired.

The position usually taken is the lateral one, with the head rotated towards the plate. It is then possible to get a fairly good outline of the seven cervical vertebræ and the adjacent portions of the base of the skull. The bodies of the cervical vertebræ are readily shown, but to get accurate outlines the head must not be moved to either side.

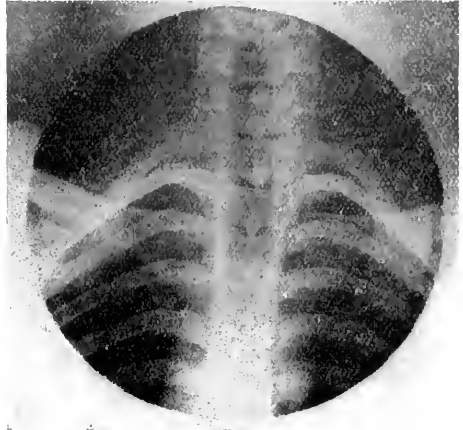

FIG. 110.—Normal cervical and upper dorsal region showing the sterno-clavicular articulation. This position is useful when examinations for cervical ribs have to be made.

## The Bones of the Chest

*The Clavicles* may be examined in their entire length, or in sections when the shoulder or upper thorax are in the picture. The patient is placed with the plate on the front of the chest, and the tube is operated either from below or from above, whichever is the more convenient.

*The Sternum* has often to be examined, the position in which it is usually taken being from behind forwards. The picture is usually confused by the shadows of the mediastinum and spinal column. An oblique lateral view

of the thorax enables us to examine the whole of the sternum with its articulations. The picture is naturally somewhat distorted, but nevertheless a good idea may be obtained of its condition, injuries and tumours being readily shown. The ribs can be shown in these positions, the lateral position showing the ribs in their entirety.

### The Dorsal Spine

Two methods are used here : (1) an antero-posterior, with the plate on the posterior aspect of the spine; (2) a direct lateral view. The latter may be obtained by placing the plate on one side and the tube on the other, the arms being extended above the head, to get rid, so far as is possible, of the shadows of the scapulæ. The bodies of the vertebræ are then well seen, as is also the posterior portion of the column with the transverse process, the laminae, and spines of the vertebræ. The spinal canal can also be seen in the plate.

In taking the antero-posterior view, it is well to have the tube a good distance away from the plate, the greater the distance the better being the detail shown in the bones. The exposure has to be proportionately prolonged, and if the tube is soft a longer exposure is further necessary. In examining the spine of children for curvature, etc., the author obtains good pictures by placing the tube four or five feet from the plate.

Stereoscopic radiographs should always be taken of these spinal cases, as much more detail can be shown when they are examined in a stereoscope. This method is most useful in extensive caries of the spine when there is considerable deformity, as the picture is sharp, and fine changes in the bones can be detected. When the spine alone is required the diaphragm of the tube box should be closed down in order to get a long, narrow, slit-like aperture; this ensures better detail in the parts required.

### The Lumbar Spine

This is radiographed in the antero-posterior position, from the lower dorsal to the sacrum, by using a large extension tube with compression of the abdominal contents. It is an advantage in all positions of the spine, thorax, and abdomen, to diminish the movements of the parts as much as possible. The methods of compression employed are various. If working from below, it is an easy matter to have some simple form of compressor attached to the upper aspect of the couch. An air-cushion is placed between the patient and the couch to compress the abdominal contents. When using the tube above the couch, the compression may be obtained by fastening stout linen bands to the couch, carrying them round the patient, and fixing on the opposite side. A long extension tube may be attached to the tube-holder, and fixed down on the patient by a mechanical device. These are all matters of detail which can be arranged to suit the individual worker, but whichever method is employed there can be no question of the great advantages of compression.





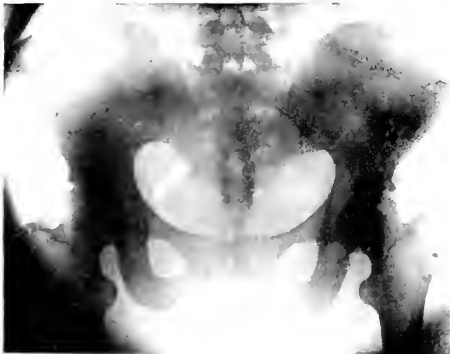
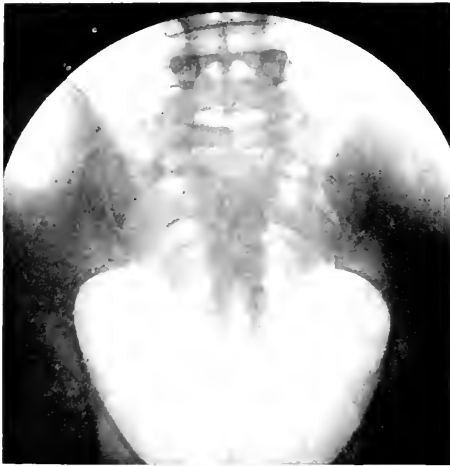

PLATE V.—NORMAL LUMBAR SPINE AND PELVIS.

- a.* Normal lumbar spine.
- b.* Normal male pelvis.
- c.* Normal female pelvis.

## The Pelvis

This region often requires most careful examination, for injuries, disease, or calculi. The positions are again two, antero-posterior and postero-anterior, both being useful. To get fine detail of the sacrum an extension tube is used, and it should be pressed well down into the pelvic cavity. The whole pelvis, with the heads of the femora and the acetabula, can be obtained by using a large plate behind the patient, or by placing the patient on the anterior surface with the plate underneath, the tube being placed above the posterior aspect of the patient. For the examination of the coccyx a small extension tube should be used, and the tube tilted forward into the cavity of the pelvis, the plate being placed on the posterior aspect beneath the patient.

## The Upper Extremity

**The Examination of the Clavicle.**—The clavicle requires to be considered in its whole length. Either extremity will appear in radiographs of the shoulder and of the thorax. The external end has frequently to be examined for displacements and injuries. The acromial end of the clavicle is seen in the several plates illustrating the shoulder-joint.

**Examination of the Shoulder-joint.**—The shoulder-joint calls for minute description. It is frequently injured, and should be carefully examined in all cases of suspected injury to that region. It is usually examined in the antero-posterior position, first with the plate on the posterior aspect of the joint with the tube in front, and then with the plate placed on the anterior aspect with the tube behind. It should always be examined in these two positions, if one is to demonstrate an injury in the shoulder-joint. The anti-cathode should be centred as nearly as possible over the coracoid process. An extension tube should be used, and slight pressure applied to the part. The pictures obtained by these two positions differ in several points of detail, the differences being readily seen when the two radiographs are compared. The anatomical points seen in the pictures should be—(1) the head of the humerus; (2) the glenoid cavity; (3) the axillary border of the scapula; (4) the coracoid process; (5) the acromion process; (6) the acromial end of the clavicle. It is usual in such examinations to have the arm by the side. Supplementary skiagrams can be obtained by extending the arm out from the side or carrying it directly upwards in line with the long axis of the body. When it is necessary to examine the tuberosities the arm may be rotated in the direction necessary to show either one. Should the axillary border be suspected, the arm should be carried upwards and forwards and rotated outwards, so as to bring the body of the scapula away from the trunk.

Plate VI., Fig. *b* shows the appearance of the parts when the plate is placed on the anterior aspect of the joint.

The acromion process is best shown when the plate is placed on the

posterior aspect of the joint, with the tube in front, it being then possible to demonstrate the whole of the process and the spine of the scapula, while the infra- and supra-spinous fossæ can also be shown in their entirety. The coracoid process is well seen in all of the shoulder negatives, and changes in its position can be shown, fractures being readily demonstrated.

When fine detail is necessary, and an injury is known to exist in the region of the coracoid process, a small picture should be obtained, an extension tube being centred over the process, and the plate being either on the posterior or anterior aspect of the joint. The greater tuberosity of the humerus will be clearly shown. Its position and appearance will vary with the position of the shaft of the bone at the time, as regards rotation outwards or inwards. With the arm abducted and carried over the head, the shoulder-joint alters considerably in appearance. The head of the humerus and the glenoid cavity are well demonstrated, and the coracoid process is also well seen.

The spine and body of the scapula are often investigated for evidence of fracture or tumour. The bone shows well in any of the usual positions, but if the vertebral border is under inspection, it is necessary to take a plate with the patient lying on it, and the arm abducted and carried upwards towards the head.

**The Elbow-joint.**—Four positions are available in this joint, and each may be modified by the position in which the limb is placed at the time.

(1) Antero-posterior, with plate on the front of the limb.

(2) Antero-posterior, with plate on the back of the limb.

(3) Lateral internal, with plate on the inner aspect of the joint, the arm being either flexed or extended.

(4) Lateral external, plate on outer aspect of the joint, the forearm flexed or extended.

Good pictures of the head of the radius and its articulation can be obtained by slightly flexing and pronating the forearm.

**The Radius and Ulna** should always be taken in two positions: (1) lateral, (2) antero-posterior.

**The Wrist-joint** must always be examined in two planes, the antero-posterior and the lateral. In both positions the tube is centred over the carpus. Compression on the limb may be effected by using a long extension tube, pads of lamb's wool being applied over the part, or sand-bags may be used to steady the limb.

**Metacarpal Bones and Phalanges.**—These frequently call for careful examination. Antero-posterior and lateral pictures may readily be obtained, but lateral pictures of the middle metacarpal bones are very difficult to obtain. The hand is placed obliquely on a plate, and the tube directed well in front of the middle line. The picture is somewhat distorted. Lateral views of the phalanges can be procured by placing a plate between the fingers.



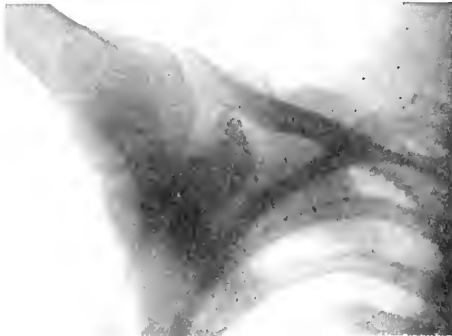

PLATE VI.—NORMAL SHOULDER-JOINT.

- a.* Normal shoulder-joint, plate on posterior aspect of joint.  
*b.* Normal shoulder-joint, plate on anterior aspect.  
*c.* Normal shoulder-joint, arm abducted.

## The Lower Extremity

The bones of the pelvis are seen in most of the radiographs taken for the bladder and ureters. The sacrum is readily shown by putting a plate beneath the patient, and using a compression tube from above. In large pictures of the region the acetabula with the head of the femur are well shown.

When the two joints are required for comparison, a good method is to radiograph the lower pelvis, centering the tube just below the symphysis pubis. Good detail is obtained of the head of the bones, and a good outline of the acetabulum.

The iliac bones, which often require to be radiographed for fracture, tumour, etc., may be examined in two positions, with the tube centred over the middle of each bone, from the front.

**The Hip-joint** is probably one of the joints most frequently examined. Two positions are available :

(a) The posterior, when the plate is placed below the patient and the tube centred over the head of the bone.

(b) The anterior, with the plate on the front of the joint and the tube centred behind.

Both are useful, and either may give valuable information. The important point is to make sure that good detail is obtained. This joint is the most difficult of all the joints from which to obtain good radiographs.

A third position has already been described, where the plate is behind the patient and the tube centred just above the symphysis pubis.

However obtained, a good radiograph should show the head of the femur, the cotyloid notch should be visible, the rim of the acetabulum should be seen superimposed over the head of the bone, and in normal joints the inter-articular space should be shown. The picture should include the greater and lesser trochanter and the upper third of the shaft of the femur. The ischium and pubis should come into the picture, as should also the lower half of the ilium. In some instances the limb may be abducted and rotated outwards to throw the head of the femur into prominence.

**The Shaft of the Femur** may be taken in two directions, antero-posterior and lateral. Only the lower two-thirds can be seen in the latter position. When the whole bone is required long, narrow plates must be used, the tube requiring to be centred at a longer distance, in order to get the whole of the bone. The lateral view of the femur may be taken from either side.

**The Knee-joint.**—This important joint requires careful examination. (a) Both knee-joints may be taken on one plate. The tube is centred over the space between the two joints, and either an anterior or posterior view may be obtained. (b) Plate on posterior aspect of joint, tube in front. (c) Plate on anterior aspect, tube behind. The patella is well seen by this method of examination.

For the patella alone, the plate is placed on the front and the tube centred just outside the external border of the shaft, and directed obliquely down-

wards to avoid the shadow of the femur obscuring that of the patella. Plates taken in this position give good detail of the component parts of the joint. Fine detail should always be aimed at in these examinations. It is often possible to show apparently slight injury to the bone without an actual fracture. At a later date this may become the seat of chronic inflammatory changes, or tuberculosis of a joint may be a sequel to such an injury.

The points to observe are the general contour of the articular surface, and the space between the condyles, which is usually occupied by cartilage, but which frequently does not show any detail of the articular surface, though plates taken with a very soft tube show shadowy detail of the cartilages and the softer structures of the joint. The normal position of the patella, the articular surface of the upper end of the tibia, and the spine of the tibia should be noted. This is of great importance, for when cases are examined for injuries of the joint we must not overlook the relations of these parts to one another.

(*d*) The lateral view of the knee-joint is the most useful one from the point of view of diagnosis. In it we see the relations of the bony surfaces and a faint line of the articular cartilage, while in some instances the shadow of the internal articular cartilage is seen in a very faint, somewhat striated shadow. The outline of the patella is sharp and clearly cut, the pad of fat below the patella is frequently shown, and the ligamentum patellæ can be traced from the lower edge of the patella to its insertion into the tuberosity of the tibia. The two condyles of the lower end of the femur are clearly seen, and the head of the fibula with its articulation to the tibia is also shown. This view of the knee-joint may be taken from either side—internal or external.

**The Tibia and the Fibula.**—These bones may be radiographed from the front or the back, or laterally, from the inner or outer aspects of the limb.

**The Ankle-joint.**—There are four positions for the examination of this joint :

(*a*) Anterior, plate on the front of the limb.

(*b*) Posterior, plate on the posterior aspect of the limb, the foot at right angles to the leg.

(*c*) Lateral internal.

(*d*) Lateral external.

**The Bones of the Foot: Tarsal, Metatarsal, and Phalanges.**—

For a general survey of the foot, the plate may be placed upon the inner aspect and the tube centred over the mid-point between the os calcis and the end of the toes.

By making another exposure the outer aspect of the foot may be brought into closer contact with the plate.

The os calcis can be examined in three positions :

(1) In the lateral position, plate on outer aspect of foot

(2) Lateral aspect, plate on inner side of the foot.

(3) With a plate placed under the foot, the patient standing upon it, the tube being centred behind the bone, well above the insertion of the tendo



Achillis, and directed obliquely downwards and forwards. A good view of the whole bone may be obtained in this way.

To obtain a reliable radiograph of the metatarsus and phalanges, the foot is placed upon the plate and the tube is directed downwards and slightly towards the heel. The patient may stand upon the plate ; or if he is lying on the back, the knee-joint is flexed, and the plantar aspect of the foot is placed in contact with the plate.

## THE DEVELOPMENT OF THE BONES

The importance of this section is great, as it is necessary to know the details of ossification and union of these bones. The following descriptions and drawings are based on those from well-known works on anatomy. The dates given are those which have long been recognised as the correct ones, but it is quite probable in the near future that many of those quoted may have to be revised as a result of systematic investigation on bone ossification by means of X-ray examinations. It is possible by this means to ascertain accurately the normal dates of union, but until the work of X-ray examination has been completely carried out it will be necessary to use the work of the anatomist.

The chief times of union need only be considered in those bones which are most likely to be injured. The ends of the long bones, the scapula, and the pelvis chiefly interest the radiographer. The usefulness of a complete though necessarily short description cannot be overestimated. Diagrams and skiagrams will be used to illustrate changes, though it is obviously impossible to include examples of the epiphyses at all ages. It is hoped that this section will be found useful for reference, as it is hardly possible for the radiographer to carry all the dates in his mind.

**The Clavicle.**—Commencing with the bones of the upper extremity, we note that this bone is developed from three centres, two for the shaft and one for the sternal extremity. The centre for the shaft appears very early, *before any other bone*; according to Beclard, as early as the thirtieth day. The centre for the sternal end makes its appearance about the eighteenth or twentieth year, and unites with the rest of the bone about the twenty-fifth year.

**The Scapula.**—Development takes place by seven centres: one for the body, two for the coracoid process, two for the acromion, one for the posterior border, and one for the inferior angle. Ossification of the body of the scapula commences about the second month of fetal life by the formation of an irregular plate of bone immediately behind the glenoid cavity. This plate extends itself so as to form the chief part of the bone, the spine growing up from its posterior surface about the third month. At birth the chief part of the scapula is osseous, the coracoid and acromion processes, the posterior border and inferior angle being cartilaginous. About the first year after birth ossification takes place in the middle of the coracoid process, which

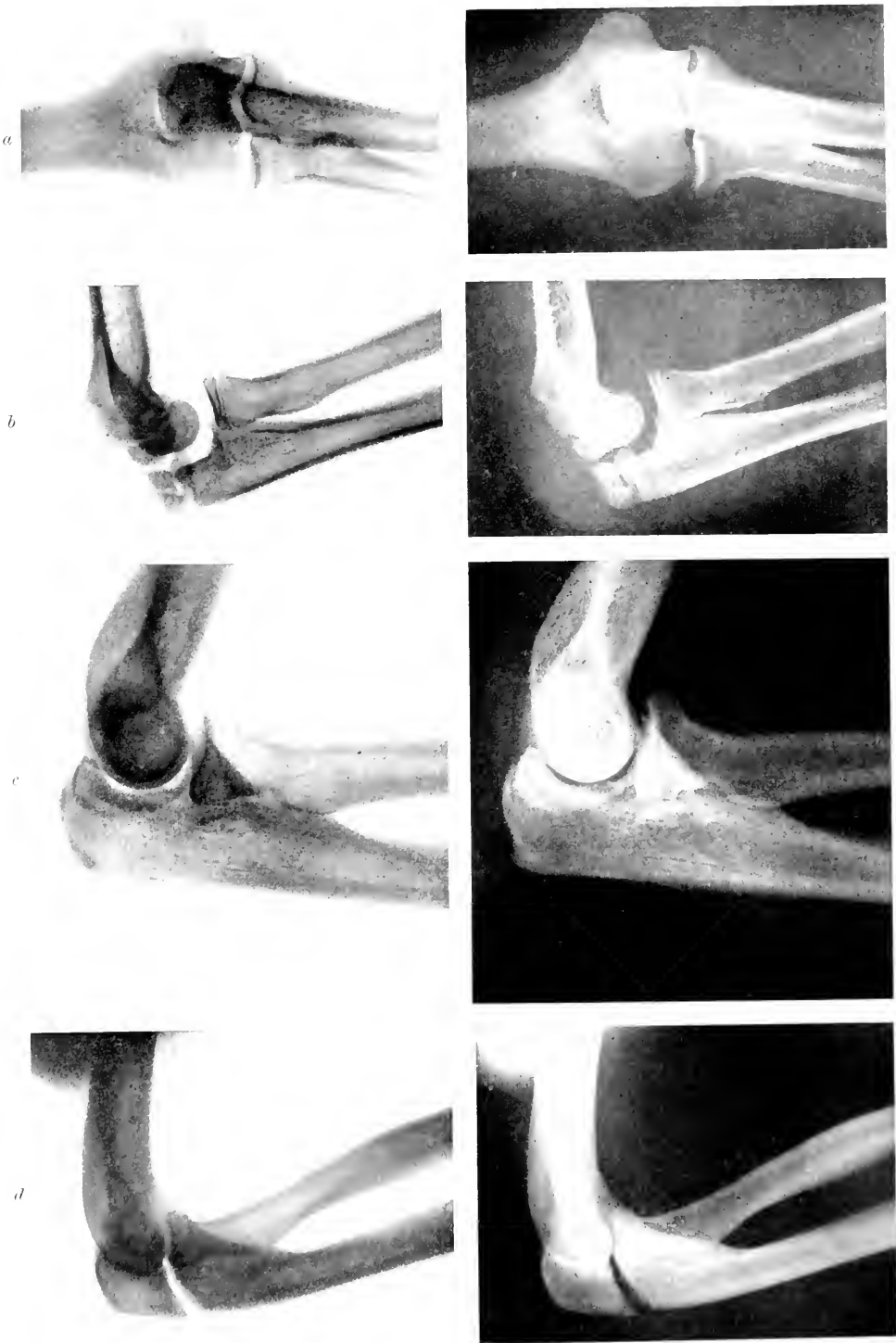

PLATE VII. NORMAL ELBOW AND FRACTURES IN REGION OF ELBOW-JOINT.

- a.* Normal elbow-joint, antero-posterior position.
- b.* Injury to epiphysis of olecranon.
- c.* Normal elbow-joint, lateral position.
- d.* Fracture through olecranon process.



usually becomes joined with the rest of the bone at the time when the other centres make their appearance. Between the fifteenth and seventeenth years ossification of the remaining centres takes place in quick succession, and in the following order: first, near the base of the acromion and in the root of the coracoid process, the latter appearing in the form of a broad scale; secondly, in the inferior angle and contiguous part of the posterior border; thirdly, near the extremity of the acromion; and fourthly, in the posterior border. The acromion process, besides being formed of two separate nuclei, has its base formed by an extension into it of the centre of ossification which belongs to the spine, the extent of which varies in different cases. The two separate nuclei unite, and then join with the extension carried in from the spine. These various epiphyses become joined to the bone between the ages of twenty-two and twenty-five years. Sometimes failure of union between the acromion process and spine occurs, the junction being formed by fibrous tissue or by an imperfect articulation. In some cases of supposed fracture of the acromion with ligamentous union it is probable that the detached segment was never united to the rest of the bone.

**The Humerus.**—Development takes place by eight centres: one for the shaft, one for the head, one for each tuberosity, one for the radial head, one for the trochlear portion of the articular surface, and one for each of the condyles. The nucleus for the shaft appears near the centre of the bone in the eighth week, and soon extends towards the extremities. At birth the humerus is ossified nearly in its whole length, the extremities remaining cartilaginous. At the beginning of the second year ossification commences in the head of the bone, and during the third year the centre for the tuberosities makes its appearance usually by a single ossific point, but sometimes, according to Beclard, by one for each tuberosity, that for the lesser being small and not appearing until after the fourth year. By the fifth year the centres for the head and tuberosities have enlarged, and become joined so as to form a single large epiphysis.

The lower end of the humerus is developed in the following manner:—At the end of the second year ossification commences in the radial portion of the articular surface, and from this point extends inwards, so as to form the chief part of the articular end of the bone, the centre for the inner part of the articular surface not appearing until about the age of twelve. Ossification commences in the internal condyle about the fifth year, and in the external one not until about the thirteenth or fourteenth year. At about sixteen or seventeen years the outer condyle and both portions of the articulating surfaces (having already joined) unite with the shaft. At eighteen years the inner condyle becomes joined, whilst the upper epiphysis, although the first formed, is not united until about the twentieth year.

**The Ulna.**—Development takes place by three centres: one for the shaft, one for the inferior extremity, and one for the olecranon. Ossification commences near the middle of the shaft about the eighth week, and soon extends through the greater part of the bone. At birth the ends are cartilaginous. About the fourth year a separate osseous nucleus appears in the

middle of the head, which soon extends into the styloid process. At about the tenth year ossific matter appears in the olecranon near its extremity, the chief part of this process being formed from an extension of the shaft into it. At about the sixteenth year the upper epiphysis becomes joined, and at about the twentieth year the lower one.

**The Radius.**—Development takes place by three centres, one for the shaft and one for each extremity. That for the shaft makes its appearance near the centre of the bone, soon after the development of the humerus commences. At birth the shaft is ossified, but the ends of the bone are cartilaginous. About the end of the second year ossification commences in the lower epiphysis, and about the fifth year in the upper one. At the age of seventeen or eighteen the upper epiphysis becomes joined to the shaft, the lower epiphysis becoming united about the twentieth year.

**The Bones of the Hand.**—The *carpal bones* are each developed by a single centre. At birth they are all cartilaginous. Ossification proceeds in the following order: in the os magnum and unciform an ossific point appears during the first year, the former preceding the latter; in the cuneiform, at the third year; in the trapezium and semilunar, at the fifth year, the former preceding the latter; in the scaphoid, at the sixth year; in the trapezoid, during the eighth year; and in the pisiform, about the twelfth year.

The *metacarpal bones* are each developed by two centres, one for the shaft and one for the digital extremity, for the four inner metacarpal bones; one for the shaft and one for the base, for the metacarpal bone of the thumb, which in this respect resembles the phalanges. Ossification commences in the shaft about the eighth or ninth week, and gradually proceeds to either end of the bone. About the third year the digital extremities of the four inner metacarpal bones and the base of the first metacarpal bones commence to ossify, and they unite about the eighteenth year.

The *phalanges* are each developed by two centres, one for the shaft and one for the base. Ossification commences in the shaft in all three rows at about the eighth week, and gradually involves the whole of the bone excepting the upper extremity. Ossification of the base commences between the third and fourth years, and a year later in those of the second and third rows. The two centres become united in each row between the eighteenth and twentieth years.

**The Os Innominatum** is a large, irregularly shaped bone, which, with that of the opposite side, forms the sides and anterior walls of the pelvic cavity. In young subjects it consists of the separate parts which meet and form the large cup-shaped cavity situated near the middle of the outer side of the bone; and although in the adult these have become united, it is usual to describe the bone as divisible into three portions: the ilium, the ischium, and the pubes. Development takes place by eight centres: three primary, one for the ilium, one for the ischium, and one for the pubes; and five secondary, one for the crest of the ilium, one for the anterior inferior spinous process (said to occur more frequently in the male than in the female), one for the tuberosity of the ischium, one for the symphysis pubis (more



PLATE VIII. NORMAL KNEE-JOINT.

*a*, Normal knee-joint, lateral view.

*b*, Knee-joint in young adult, irregularity in region of tubercle of tibia.

*c*, Normal knee-joint, antero-posterior.





frequent in the female than in the male), and one for the Y-shaped piece at the bottom of the acetabulum.

These various centres appear in the following order : (*a*) in the ilium, immediately above the sciatic notch, at about the same period as the development of the vertebræ commences ; (*b*) in the body of the ischium, at about the third month of foetal life ; and (*c*) in the body of the pubes, between the fourth and fifth months. At birth the three primary centres are quite separate, the crest, the bottom of the acetabulum, and the rami of the ischium and pubes being still cartilaginous. At about the seventh or eighth year the rami of the pubes and ischium are almost completely ossified. About the thirteenth or fourteenth year the three divisions of the bone have extended their growth into the bottom of the acetabulum, being separated from each other by the Y-shaped portion of cartilage, which now presents traces of ossification. The ilium and ischium then become joined, and lastly the pubes, through the intervention of the Y-shaped portion. At about the age of puberty ossification takes place in each of the remaining portions, and they become joined to the rest of the bone about the twenty-fifth year. It is important to bear in mind the development of the bones entering into the hip-joint, as this region has to be frequently examined for injuries and disease.

**The Femur.**—The femur is developed by five centres : one for the shaft, one for each extremity, and one for each trochanter. Of all the long bones except the clavicle it is the first to show ossification ; this commences in the shaft about the fifth week of foetal life, the centres of ossification appearing in the epiphyses in the following order : first in the lower end of the bone at the ninth month of foetal life—from this the condyles and tuberosities are formed ; in the head at the end of the first year of birth ; in the great trochanter during the fourth year ; and in the lesser trochanter between the thirteenth and fourteenth years. The order in which the epiphyses are joined to the shaft is the reverse of that of their appearance ; their junction does not commence until after puberty, the lesser trochanter being first joined, then the greater, then the head, and lastly the inferior extremity (the first in which ossification commenced), which is not united until the twentieth year.

**The Patella.**—Development takes place by a single centre, which makes its appearance about the third year. In two instances it has been seen cartilaginous throughout at a much later period (six years). More rarely the bone is developed by two centres placed side by side. Ossification is completed about the age of puberty.

**The Tibia.**—Development takes place by three centres, one for the shaft and one for each extremity. Ossification commences in the centre of the shaft about the seventh week, and gradually extends towards either extremity. The centre for the upper epiphysis appears at birth. It is flattened in form, and has a thin tongue-shaped process in front, which forms the tubercle. That for the lower epiphysis appears in the second year. The lower epiphysis joins the shaft at about the eighteenth, and the upper one about the twentieth year. Two additional centres occasionally exist : one

for the tongue-shaped process of the upper epiphysis, the tubercle, and one for the inner malleolus.

**The Fibula.**—Development takes place by three centres, one for the shaft and one for each extremity. Ossification commences in the shaft about the eighth week of foetal life, a little later than in the tibia, and extends gradually towards the extremities. At birth both ends are cartilaginous. Ossification commences in the lower end in the second year, and in the upper one about the fourth year. The lower epiphysis, the first in which ossification commences, becomes united to the shaft first, contrary to the law which appears to prevail with regard to the junction of epiphysis with diaphysis. This takes place about the twentieth year. The upper epiphysis is joined about the twenty-fifth year.

**The Bones of the Foot.**—The *tarsal bones* are each developed by a single centre, excepting the os calcis, which has an epiphysis for its posterior extremity, just below the insertion of the tendo Achillis. It is seen as a small oval disc. The centres make their appearance in the following order: os calcis, at the sixth month of foetal life; astragalus, about the seventh month; cuboid, at the ninth month; external cuneiform, during the first year; internal cuneiform, in the third year; middle cuneiform and scaphoid, in the fourth year. The epiphysis for the posterior extremity of the os calcis appears at the tenth year, and unites with the rest of the bone soon after puberty.

The *metatarsal bones* are each developed by two centres: one for the shaft and one for the digital extremity in the four outer metatarsals; one for the shaft and one for the base in the metatarsal bone of the great toe. Ossification commences in the centre of the shaft about the ninth week and extends towards either extremity, and in the digital epiphysis about the third year; they become joined between the eighteenth and twentieth years.

The *phalanges* are developed by two centres for each bone, one for the shaft and one for the metatarsal extremity.

**The Hyoid Bone** is a bony arch, shaped like a horse-shoe, and is of a quadrilateral form. Development takes place by six centres, two for the body and one for each cornua. Ossification commences in the body and greater cornua towards the end of foetal life, the centres for the cornua first appearing. Ossification at the lesser cornua commences some months after birth.

**The Sternum** is a flat narrow bone, situated in the median line in the front of the chest, and consisting in the adult of three portions—the manubrium, the gladiolus, and the ensiform or xiphoid appendix. The sternum, including the ensiform appendix, is developed by six centres—one for the first piece or the manubrium, four for the second piece or gladiolus, and one for the ensiform appendix. Up to the middle of foetal life the sternum is entirely cartilaginous, and when ossification takes place the ossific granules are deposited in the middle of the intervals, between the articular depressions for the costal cartilages, in the following order: in the first piece, between the fifth and sixth months; in the second and

third, between the sixth and seventh months; in the fourth piece, at the ninth month; in the fifth, within the first year, or between the first and second years after birth; and in the ensiform appendix, between the second and the seventeenth and eighteenth years by a single centre, which makes its appearance at the upper part and proceeds gradually downwards. To these may be added the occasional existence, as described by Breschet, of two small episternal centres, which make their appearance, one on each side of the sterno-clavicular notch. These are regarded by him as the anterior rudiments of a rib, of which the posterior rudiment is the anterior lamina of the transverse process of the seventh cervical vertebra. It occasionally happens that some of the segments are formed from more than one centre, the number and position of which vary. Thus the first piece may have two, three, or even six centres. When two are present, they are generally situated one above the other, the upper one being the larger. The second piece has seldom more than one. The third, fourth, and fifth pieces are often formed from two centres, placed laterally, the irregular union of which will serve to explain the occasional occurrence of the sternal foramen or of the vertical fissure which occasionally intersects this part of the bone. Union of the various centres commences from below and proceeds upwards, taking place in the following order: the fifth piece is joined to the fourth soon after puberty; the fourth to the third between the twentieth and twenty-fifth years; the third to the second between the thirty-fifth and fortieth years; the second is occasionally joined to the first, especially at an advanced age.

**Ossification of the Skull and the Vertebral Column.**—It is unnecessary to deal extensively with the development of these bones. In *the vertebral column* each vertebra is ossified from three centres, two for the vertebral arch and one for the body. About the sixteenth year five secondary centres appear: one for the extremity of each transverse process, one for the extremity of the spinous process, one for the upper and one for the lower surface of the body. These fuse with the rest of the body about the age of twenty-five years.

These are the main points in the ossification of the vertebral column; but there are exceptions in the case of the first, second, and seventh cervical, and in the lumbar vertebræ.

*The atlas* is usually ossified from three centres.

*The axis* is ossified from five primary and two secondary centres.

*The seventh cervical* varies in its departures from the normal. A cervical rib is due to a persistence as a separate piece of the costal part, which becomes lengthened laterally and forwards.

*The lumbar vertebræ* have each two additional centres for the mammillary processes. The transverse process of the first lumbar is sometimes developed as a separate piece, which may remain permanently un-united with the rest of the body, thus forming a lumbar rib, a peculiarity rarely met with.

### Radiographic Survey of the Joints showing Epiphyses

**The Ankle-joint.**—The lower epiphyses of the tibia and fibula are best seen in an antero-posterior view of the joint. The epiphyseal line is nearly horizontal in the case of both bones, but that of the fibula is at a lower level and comes opposite the ankle-joint. The internal malleolus forms the inner portion of the lower tibial epiphysis, while the external malleolus is practically

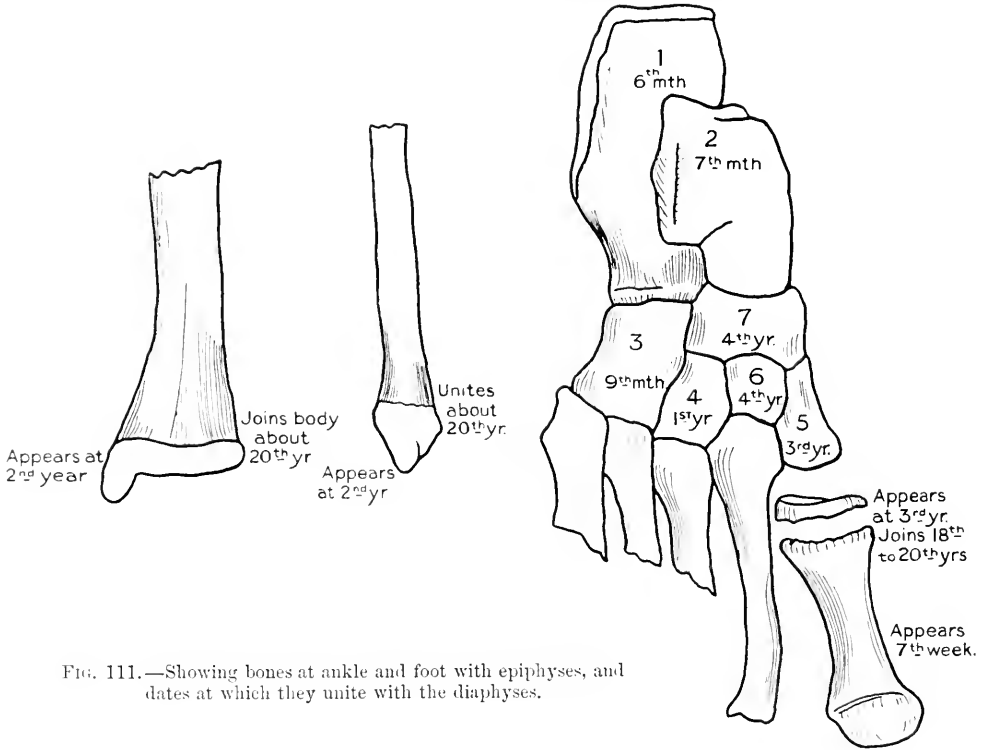

FIG. 111.—Showing bones at ankle and foot with epiphyses, and dates at which they unite with the diaphyses.

entirely composed of the lower epiphysis of the fibula. The latter epiphysis is greatly concerned in the increase in length of the fibula.

#### TABLE OF DEVELOPMENT OF THE TARSUS

The tarsal bones develop by a single centre. They appear approximately as follows :—

Os calcis . . . . .	Sixth month of foetal life.
Sometimes this bone develops from two or three centres of ossification.	
Astragalus . . . . .	Seventh month of foetal life.
Cuboid . . . . .	Ninth month of foetal life.
External cuneiform . . . . .	First year.
Internal cuneiform . . . . .	Third year.
Middle cuneiform . . . . .	Fourth year.
Scaphoid . . . . .	Fourth year.

The ossific centre for the epiphysis of the os calcis appears at the ninth year, and may sometimes unite before puberty. It may develop from two centres.



FIG. 112.—Foot.

Antero-posterior view, plantar aspect of foot on plate. Age 14.

**Knee-joint.**—The epiphyses entering into the formation of this joint are of the greatest importance, for it is one of the joints most frequently injured.

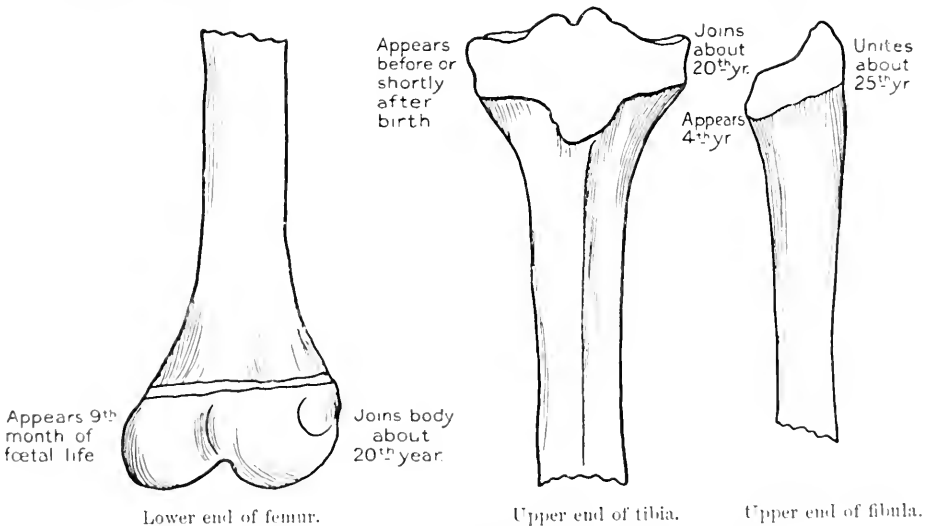

FIG. 113.—Diagram to show the epiphyses entering into the knee-joint.

The epiphysis of the lower end of the femur is the only one in which bone is formed before birth.

In an antero-posterior view it is seen as a large irregular bony mass,

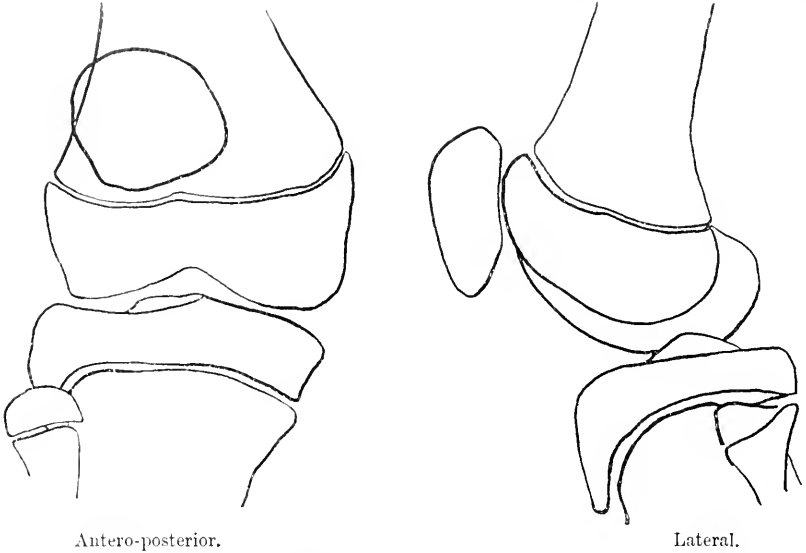

FIG. 114.—Diagrams to illustrate the appearances of the epiphyses at the knee-joint, traced from radiographs.

forming the entire lower end of the femur. The epiphyseal line is seen at

the level of the adductor tubercle on the inner side. It is wavy in outline, rises sharply towards the centre, and has a slightly lower level at the outer side of the bone.

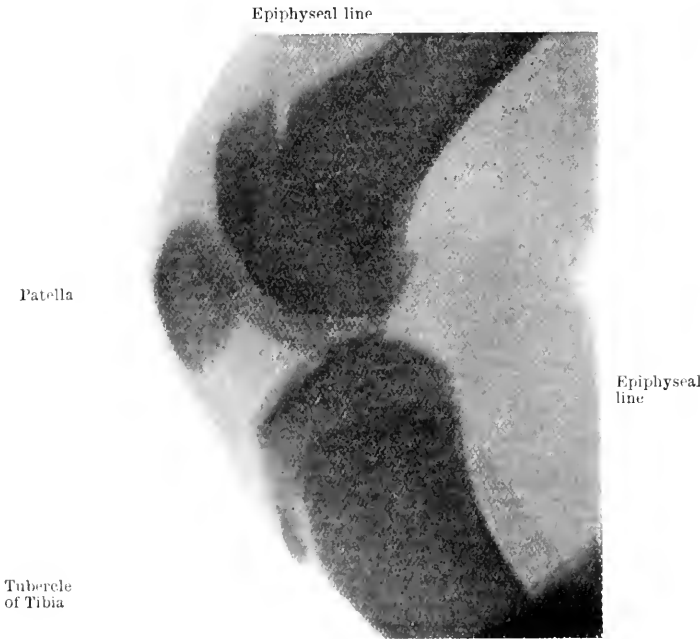

FIG. 115.—Lateral view of knee-joint, showing epiphyses. Note prolongation of tibial epiphysis on anterior aspect of tibia. Age, 14 years.

The epiphyses of the tibia and fibula will be seen in the picture. The epiphyseal line of the tibia resembles that of the line of the lower end of the femur. The upper epiphysis of the fibula is a small mass, appearing to rest on the top of the shaft.



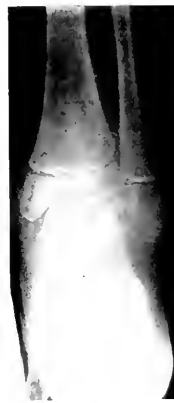

PLATE IX.—SHOWING EPIPHYSES OF HIP, KNEE, AND ANKLE JOINTS.

*a*, Pelvis and hip-joints in a child of 5-6 years.  
 Knee-joint in a child 10-12 years. *b*, Lateral view. *c*, Antero-posterior view.  
 Ankle-joint in a child 10-12 years. *d*, Lateral aspect. *e*, Antero-posterior aspect.



In a lateral view the epiphyseal lines of the femur and fibula are nearly

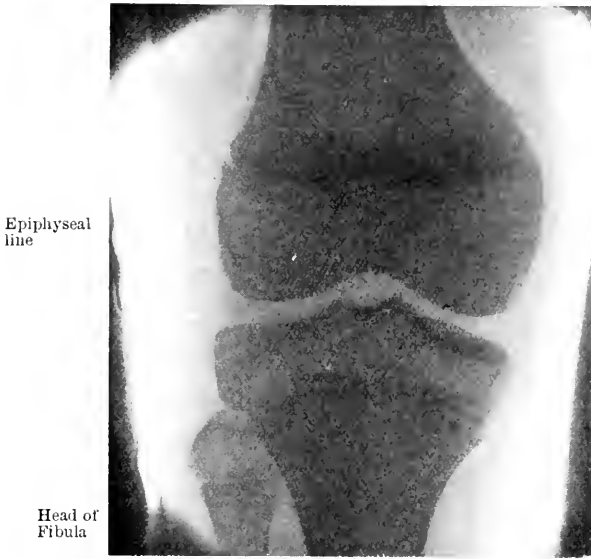

FIG. 116.—Antero-posterior view of knee-joint showing epiphyses. Plate on posterior aspect of joint.

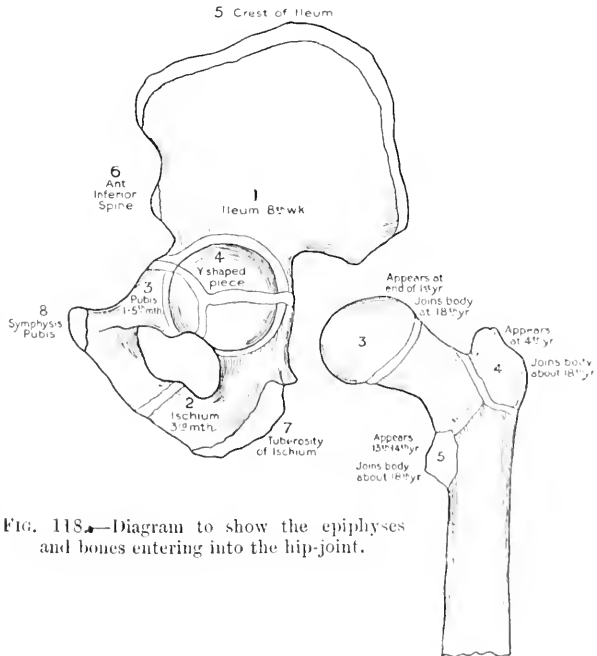

FIG. 117.—Fracture of tibia and fibula. Practically no displacement. The appearances of the epiphyses at both ends of the bones indicate the age of the patient to be about 3 years. The fibula has a convexity towards the tibia.

horizontal. The epiphysis of the upper end of the tibia is seen to have a tongue-like projection extending down the front of the bone to the tubercle of the tibia. In some instances this projection does not reach so far as the tubercle, and the latter is seen arising from a separate centre of ossification. It is frequently the seat of injury and inflammation (see Plates VIII. Fig. *b*, and XVIII. Fig. *a*).

**The Hip-joint.**

—The epiphysis of the upper end of the femur includes merely the articular head of



the bone and forms no part of the neck. In an X-ray picture it resembles somewhat the appearance of the epiphysis of the upper end of the humerus. The greater and lesser trochanters arise from separate centres of ossification, but these are less frequently seen in radiographs than is the larger epiphysis (see Plate IX. *a*).

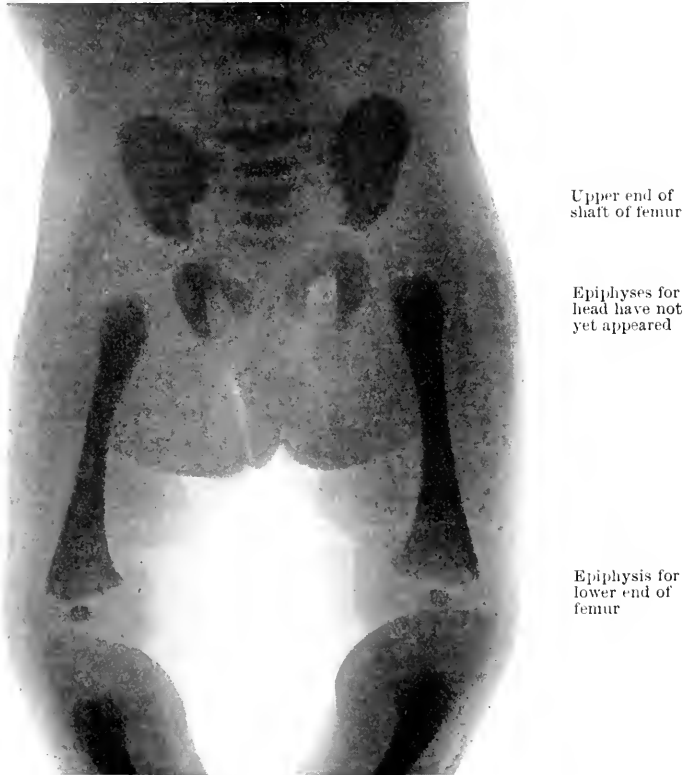

FIG. 119.—Pelvis and femora of a child two days old, showing ossification of bones of pelvis, hip and knee joints. Note lower epiphyses of femur present at birth.

**The Wrist-joint.**—The epiphysis of the lower end of the radius is seen in an antero-posterior view of the joint as a wedge-shaped shadow, and is thicker on the outer than on the inner side of the wrist. The epiphyseal line, though irregular and wavy, is never rough and jagged as in a fracture. This epiphysis has a great share in the increase in length of the shaft.

The epiphysis of the lower end of the ulna is seen at a higher level than that of the radius and shows the prominence of the styloid process on its inner side.

The centres of ossification for the carpal bones show according to the age at which the joint is examined (see "Ossification").

TABLE OF OSSIFICATION FOR CARPAL BONES

The carpus is entirely cartilaginous at birth. Centres appear for these carpal bones at the following times :

Os magnum . . .	first year.	Trapezium . . .	fifth year.
Unciform . . .	second year.	Scaphoid . . .	seventh year.
Cuneiform . . .	third year.	Trapezoid . . .	eighth year.
Semilunar . . .	fifth year.	Pisiform . . .	twelfth year.

The "os central," lying between the bones of the first and second rows, is present in man as a small cartilage situated between the "trapezoid," trapezium, os magnum, and "scaphoid," at the second month, and disappears about the fourth month of fetal life. In rare cases it persists as a separate bone in the adult.

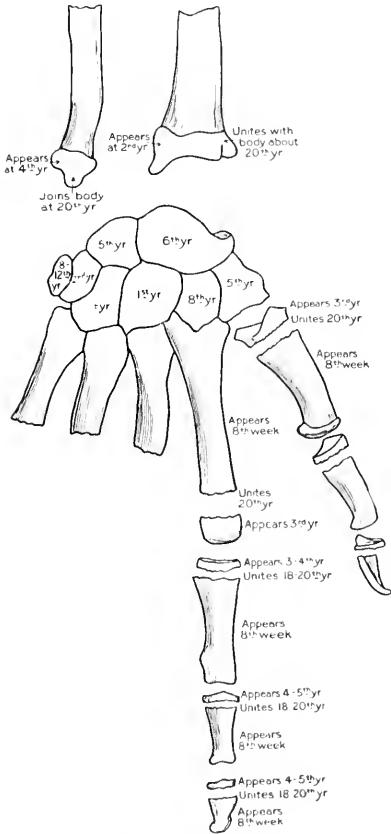

FIG. 120.—Diagram showing ossification of the bones of the hand and the wrist-joint with the times of union of epiphyses with diaphyses.



FIG. 121.—Hand of a child over five years old. Shows development of bones of lower ends of radius and ulna, carpal bones, metacarpals, and phalanges. The epiphysis for lower end of radius well developed. The ulnar epiphysis has not yet appeared. The os magnum and unciform, semilunar and cuneiform bones are also shown. The pisiform is not shown. Note also the centre for the proximal end of the metacarpal bone of the thumb.

The epiphyses of the four inner metacarpal bones are seen at the distal ends of the shafts, but in the phalanges and in the metacarpal bone of the thumb the epiphyses are found at the proximal ends of the respective bones.



FIG. 122.—Shows stage of ossification in a young adult under twenty years.

**The Elbow-joint.**—The lower epiphysis of the humerus at the age of five or six years merely shows the centre for the capitulum as a small round mass. In an antero-posterior picture of the joint it is seen as a wedge-

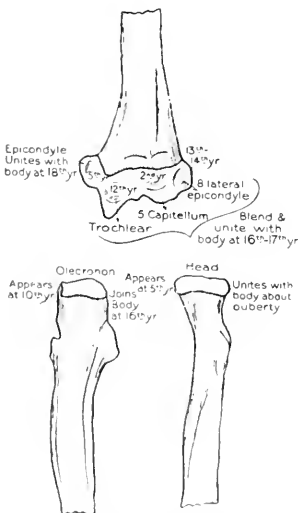

FIG. 123.—Diagram showing epiphyses of the bones forming the elbow-joint.



FIG. 124.—Elbow-joint, antero-posterior view, shows epiphyses. Age 14.

shaped mass, its lower surface being convex, and lying below the external condyle. At twelve the centres for the trochlea and the external epicon-

dyle have appeared, and have united with the centre for the capitulum, forming the lower epiphysis. The lower end of the humerus is one of the bones most frequently involved in injuries and disease, but the other bones entering into the joint should also be remembered in relation to the times at which their epiphyses join the diaphyses. The internal epicondyle is not a part of the lower epiphysis of the humerus, but is formed from a separate centre of ossification. In an X-ray picture it is seen as a small, oval mass, higher up on the innerside of the humerus, and intimately connected with the internal condyle. The epiphysis of the head of the radius is seen as a small disc, just above the upper end of the bone. In a lateral



FIG. 125.—Lateral view of elbow-joint, to show epiphyses. Age 14.

view of the joint at about five years the lower epiphysis of the humerus appears to be semilunar in shape, fitting closely to the lower end of the shaft. At a later age the parts become accentuated, and great care must be exercised in distinguishing the normal appearances when examining the joint for suspected injuries. A normal radiograph should always be compared with the suspected one if mistakes are to be avoided.

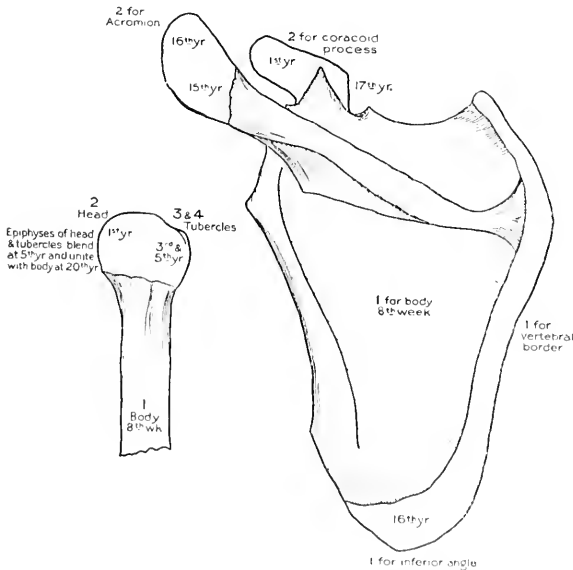

FIG. 126.—Diagram to show bones entering into the shoulder-joint. The clavicle has not been included.

**The Shoulder-joint.**—The upper epiphysis of the humerus is found as a dome-shaped mass, which appears to rest on the top of the shaft. It is composed of the centres for the head and for the greater and

lesser tuberosities, which unite to form the epiphysis. The epiphyseal line lies a little way above the surgical neck, and is not horizontal, but is higher in the middle of the shaft than at the outer and inner sides. The increase

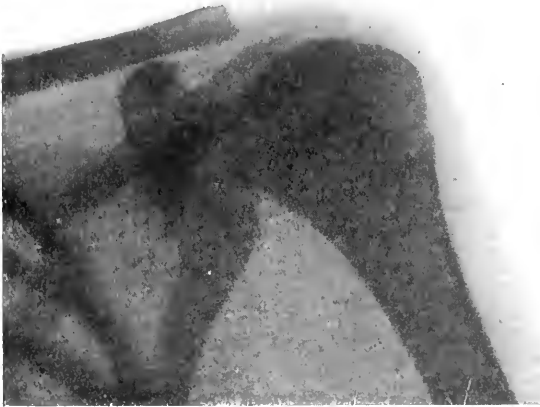

FIG. 127.—Normal shoulder-joint showing condition of epiphyses at the head of humerus.

in length of the humerus takes place principally at this epiphysis, and hence its great importance.

Certain anatomical facts are worthy of note when we are considering inflammatory conditions and injuries of the bones in the neighbourhood of joints, more especially in children and young adults. It is important to keep in mind the chief centres of ossification and the periods at which the epiphyses join the diaphyses in the joints most liable to injury; but as it is obvious that one cannot readily recall the whole of them it is hoped that a reference to the foregoing pages will be helpful. The marked differences between the appearances of joints in early youth



FIG. 128.—Shoulder-joint, showing epiphyseal line. Centres for head and great tuberosity have joined. There is evidence of a partial fracture at the surgical neck.

and in adult life must be noted to avoid errors in diagnosis. Fractures are relatively more frequent in adults, while greenstick fracture and separation of epiphyses are more prevalent in injuries occurring before the epiphyses have joined up with the diaphyses.

The after history of an injury is greatly influenced in its results when the injury occurs in the neighbourhood of the epiphyseal line. Arrested development is a frequent result of such an injury. There are, therefore, certain points which should be remembered in relation to the principal joints of the body which will be briefly mentioned, reference to figures illustrating these points being made as occasion arises.

**Sesamoid Bones.**—These are small rounded masses, cartilaginous in early life, osseous in the adult, which are developed in tendons which exert a great amount of pressure upon those parts over which they glide. It is said that they are more commonly found in the male than in the female, and in persons of an active muscular habit than in those who are weak and debilitated. They have a free articular facet.

The sesamoid bones *of the joints* in the lower extremity are: the patella, in the tendon of the quadriceps extensor; two small sesamoid bones in the tendon of the flexor brevis pollicis, opposite the metatarso-phalangeal joint of the great toe; and occasionally one at the metatarso-phalangeal joint of the second toe, of the little toe, and, still more rarely, of the third and fourth toes. In the knee-joint posteriorly there may also be one.

*In the upper extremity* they are found on the palmar aspect of the metacarpo-phalangeal joint in the thumb, developed in the tendon of the flexor brevis pollicis, occasionally one or two opposite the metacarpo-phalangeal articulations of the fore and little fingers, and still more rarely one opposite the corresponding joints of the third and fourth fingers.

Those found *in the tendons*, which glide over certain bones, occupy the following positions: one in the tendon of the peroneus longus, where it glides through the groove in the cuboid bone; one which appears later in the tendon of the tibialis anticus, opposite the smooth facet on the internal cuneiform bone; one is found in the tendon of the tibialis posticus, opposite the inner side of the astragalus; one in the outer head of the gastrocnemius behind the outer condyle of the femur, and one in the psoas and iliacus, where they glide over the body of the pubes.

Sesamoid bones are found occasionally in the *tendon of the biceps*, opposite the tuberosity of the radius; in the tendon of the glutæus maximus, as it passes over the great trochanter, and in the tendons which wind round the inner and outer malleoli.

## INJURIES OF BONES AND JOINTS

The methods which are employed for the determination of injuries of bones and joints are (1) fluoroscopy, (2) radiography. Both should be employed, the former for the determination of the presence of an injury and for the purpose of centering the tube under the injured part. In regard to diagnosis by screening only a few words of caution are necessary. While in a number of gross lesions with a degree of displacement and dislocations it is possible to make a positive diagnosis at once, it must be pointed out that a *negative diagnosis* of injury to bone should never be made on the screen examination alone. A plate should always be exposed after the screen examination has been made if the operator has not been able to detect an injury. If this procedure is followed it is possible to avoid making many serious errors in diagnosis. Fractures of the phalanges when there is no displacement are frequently unrecognisable under the screen. Crushing of the bones in the neighbourhood of a joint, sprain, fractures, and many so-called trivial injuries to bones and joints will be overlooked if the radiographic method is not employed.

The examination of the bones and joints in the normal individual is comparatively easy, in the injured patient it is often a matter of extreme difficulty to adjust the tube and plate. Great ingenuity may have to be displayed in certain cases. The best method to employ is to place the patient upon a radiographic couch. It is convenient to have a good supply of cushions, air-bags, and sand-bags in order to get a position of comparative ease for the patient. Many patients complain of the hardness of the X-ray couch.

The tube should be accurately centred in the tube-box, and its focus point should be capable of ready adjustment by movements in two directions under the couch. With a plumb line it is possible to quickly centre the tube under the central point of a joint or bone.

### Injuries of the Skull and Spine

The skull is frequently examined for evidence of fracture. Fractures may occur at the base, when they can be recognised by departures from the normal on a lateral or antero-posterior radiograph. Both positions should be taken. In children, when the sutures are very evident, care must be exercised to distinguish between these and a fracture. In the region of the temporal bone this is most important.



**Fracture of the Vault of the Skull.**—A depressed fracture can readily be detected when a lateral view of the skull is taken. The extent of the injury and the degree of depression should be noted.

Fracture at the base of the skull is difficult to determine. It may occur at any part of the base and may be represented as a fine fissure in the bone. When this occurs in the neighbourhood of the sutures it is often impossible to make a positive statement as to the nature of an injury. In children where the sutures have not closed it is still more difficult. In doubtful cases stereoscopic radio-

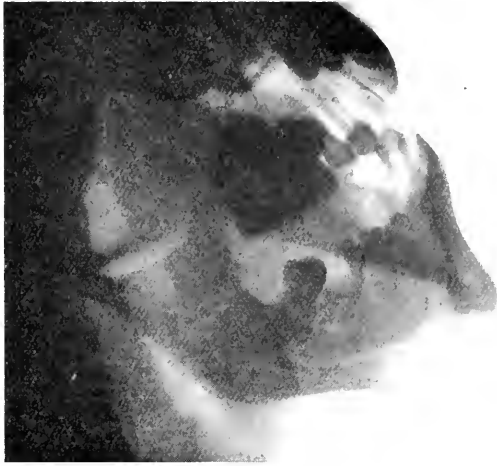

FIG. 129.—Comminuted fracture of angle of lower jaw.

This skiagram shows the teeth, particularly the roots in the lower jaw. The inferior dental canal is seen running along the jaw. One tooth shows extensive caries.



FIG. 130.—Fracture through ramus of lower jaw. The soft parts show well.

graphs should be taken. Clinical signs should always be taken into account.

**Fractures in the Orbital Region** are very difficult to distinguish. Fine detail must be obtained, and care should be exercised to obtain radiographs which show no evidence of movement on the part of the patient. This is often a matter of difficulty, because patients suffering from injury to the skull and brain are not likely to keep the head steady long enough to allow of a sufficient exposure; hence in these cases very rapid exposures are indicated, and intensifying screens should be used to cut down the exposure to the minimum. The orbital margins should be carefully examined to detect slight departures from the normal, which may be the only evidence of fracture.

**The Zygomatic Arch** is occasionally broken. There may be

a depression of the bone, this being readily detected when an antero-posterior radiograph is obtained.

**Fracture of the Superior Maxilla.**—

This may occur in head injuries, or a tooth may be driven into the antrum of Highmore. The palatine arch may be disturbed. Careful examination of the radiograph is necessary when injuries in this region are suspected.

**Fracture of the Inferior Maxilla (Mandible).**—

This bone is



FIG. 131.—Fracture dislocation of cervical vertebrae.

frequently injured. Three positions are available: (1) antero-posterior; (2) lateral; (3) film in the mouth. The condyle may be injured when the bone is subjected to direct violence. The coronoid process may be fractured either by direct or indirect violence.

It is somewhat difficult to get a good radiograph of one side of the lower jaw, because of the superimposing of the shadows. Probably the best method to employ is to centre the tube behind and a little below the angle of the jaw. With the plate on the injured side, the tube is centred over a spot behind and below the angle of the uninjured jaw, thus avoiding the overlapping of the latter.

By using the above method it is possible to obtain a picture of the side required, showing the whole of the lower jaw in profile, the temporo-maxillary articulation being well shown. This is also a useful method when it is necessary to examine the jaw for tumour or dental disease.

**Fractures of the Nasal Bones.**—These are occasionally fractured on one or both sides. A plate on the injured side is generally sufficient to show

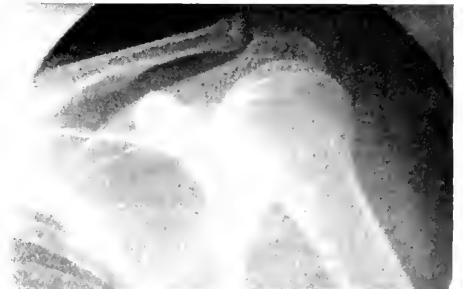
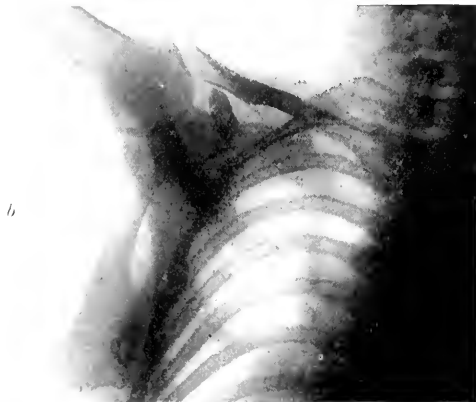
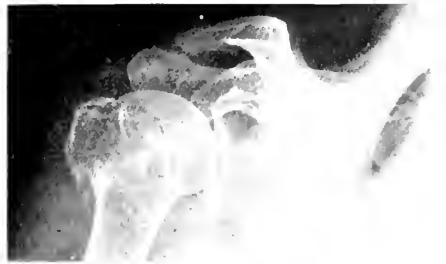
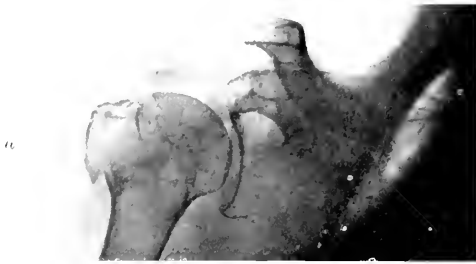

PLATE X.—FRACTURES IN REGION OF THE SHOULDER-JOINT.

- a*, Fracture through great tuberosity.  
*b*, Exostosis of angle of scapula.  
*c*, Fracture (stellate) of body of scapula; the detail has been lost in reproduction.  
*d*, Fracture at upper end of shaft of humerus, there is no displacement. Note the epiphyseal line of head of humerus.



the injury. An antero-posterior view is also useful. Stereoscopic pictures may be necessary. A small piece of X-ray film placed in contact with the side of the nose will give a sharp picture.

**Injuries of the Cervical Vertebæ.**—Two positions have already been described. The lateral is the most useful, for it shows readily very slight departures from the normal.

Fracture dislocation of the cervical vertebæ is a not uncommon injury. Any part of the cervical region may be the seat of a dislocation. The appearances are unmistakable when well marked, but the doubtful cases give rise to considerable difficulty in diagnosis. Fig. 131 illustrates a partial fracture dislocation of the upper cervical vertebæ, which was not definitely diagnosed for several weeks after the injury occurred.

**Injuries of the Dorsal Vertebæ.**—

The dorsal spine may be involved in injuries of the thorax. Ribs may be fractured and the vertebral column crushed, or partial dislocation may be present. Two positions are useful: (1) a postero-anterior, that is, the plate on the back and the tube in front; (2) a lateral, to show the bodies of the vertebæ. It is often extremely difficult to show fractures of the posterior parts of the spinal column.

Crushing and displacement of the bodies may be clearly indicated. Fracture of the transverse process sometimes occurs. When there is considerable displacement it is possible to demonstrate the position of the lesion.



FIG. 132.—Fractures of vertebral border of scapula and three ribs (gunshot wound).

## Fracture of the Ribs

The demonstration of fracture of the ribs is often a matter of great difficulty. This is particularly so when the bone is broken through and no displacement takes place. When there is considerable displacement the fracture shows up readily. The best positions for showing fractures of these

bones are antero-posterior and lateral. The latter is often a difficult position in which to show a fracture, especially in stout patients.

### Fracture of the Clavicle

(1) At the acromial end external to the trapezoid ligament, usually produced by direct violence. The inner fragment retains its position unaltered, but the outer fragment is dragged down by the weight of the arm, and forwards by the action of the muscles, so that it lies at right angles to the rest of the bones.

(2) Between the coraco-clavicular ligaments. There is little displacement. It may be shown radiographically as a fissured fracture of the bone.

(3) Through the greater convexity of the bone. There is frequently considerable displacement. (See Plate XI. Fig. *d*.)

(4) At the sternal end. This may be complicated by a partial displacement.

(5) Greenstick fracture of the clavicle, a common injury in children. Frequently only a decided bend on the bone is seen, but occasionally a minute crack may be detected.

### Fracture of the Scapula

**The Body** of the scapula may be broken in cases of injury due to direct violence, the fracture being usually of the fissured or stellate variety when the flat surface of the bone is damaged. The vertebral border is occasionally involved in these injuries.

**The Spine** of the scapula may also be fractured, generally as the result of direct violence.

**The Acromion Process** may be broken by direct violence applied to the point of the shoulder. The arm hangs powerless by the side, and the shoulder is flattened. The irregularity of the bone can be readily detected, and crepitus can be elicited by raising the elbow and rotating the arm. Occasionally merely the tip is detached, and then the above signs will not be present.

**The Coracoid Process** is rarely fractured, and only from direct violence. There is but little displacement, on account of the many powerful ligaments attached to it. In spite of the attachment of such powerful muscles as the pectoralis minor, biceps, and coraco-brachialis, the displacement is not great, as the process is kept in position by the coraco-clavicular ligament.

**The Neck** of the scapula may be fractured immediately behind the glenoid cavity, but this is a rare injury. Its existence has been doubted. Astley Cooper and South have stated that cases so described are in reality fractures of the upper end of the humerus. There is, according to South, no specimen in any of the London museums illustrating fracture of the neck of the scapula (Erichsen). Walsham describes one case of this variety of fracture which is in Guy's Hospital museum, and Rose and Carless figure an instance of this variety. It is usually due to direct violence; a portion of the

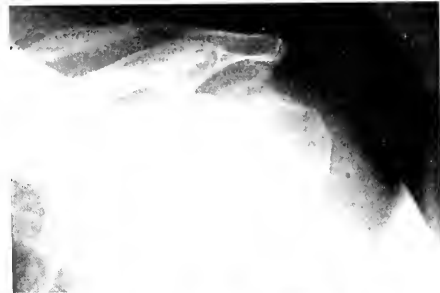
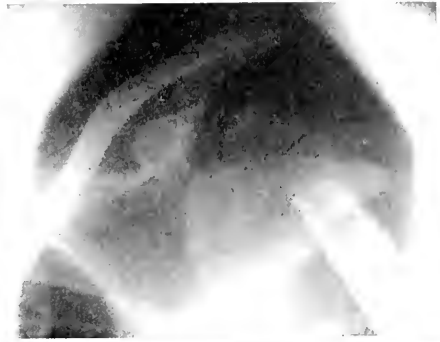

PLATE XI.—FRACTURES IN REGION OF SHOULDER-JOINT.

*a*, Fracture at upper end of humerus, a longitudinal splitting of the shaft with head displaced forwards and downwards (dislocation of the head).

*b*, Separation of the great tuberosity of the humerus.

*c*, Fracture through lower aspect of glenoid cavity.

*d*, Fracture of the clavicle (middle third), the base of the acromion process is irregular and appears to be fractured.





articular surface is broken off and displaced downwards. Plate XI. Fig. *c* illustrates a case of this rare variety of fracture through the lower segment of the glenoid cavity, with displacement downwards of the fragment. The patient was admitted to the Great Northern Central Hospital suffering from an injury to the shoulder, which was taken to be a dislocation of the head downwards. The skiagram shows the fracture and the typical displacement.

A case recorded by Spence is the first authentic instance of this fracture. A patient who had fallen upon the shoulder whilst in a state of intoxication was brought into the Edinburgh Royal Infirmary. The man died some days afterwards from meningitis. "The fracture was found to pass obliquely from below upwards and forwards, commencing about half an inch behind the origin of the long head of the triceps, and separating the neck and four-fifths of the lower part of the glenoid cavity from the scapula. The long head of the triceps and the whole of the glenoid ligament had also been torn from the upper fragment of the glenoid cavity, and carried along with the displaced portion." In fractures through the neck of the scapula, the coracoid process would necessarily follow the glenoid cavity, being detached along with it. Mobility of the coracoid would, therefore, be a valuable sign of this rare fracture.

### Fractures of the Humerus

The fractures to which this bone is liable may be conveniently divided into three groups :

(1) Those affecting the upper extremity, or that part which is situated above the surgical neck.

(2) Those of the shaft, and

(3) Those of the lower articular extremity.

**Fractures at the Upper End of the Humerus.**—(*a*) Of the *anatomical neck*, the so-called *intra-capsular fracture*. This



FIG. 133.—Fracture of shaft of humerus and upper end of radius (shrapnel wound).

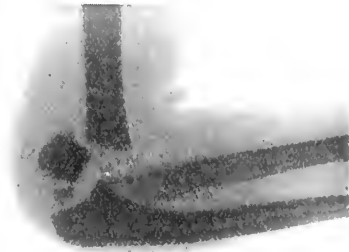

FIG. 134.—Fracture of lower end of humerus, with backward displacement of the lower fragment.

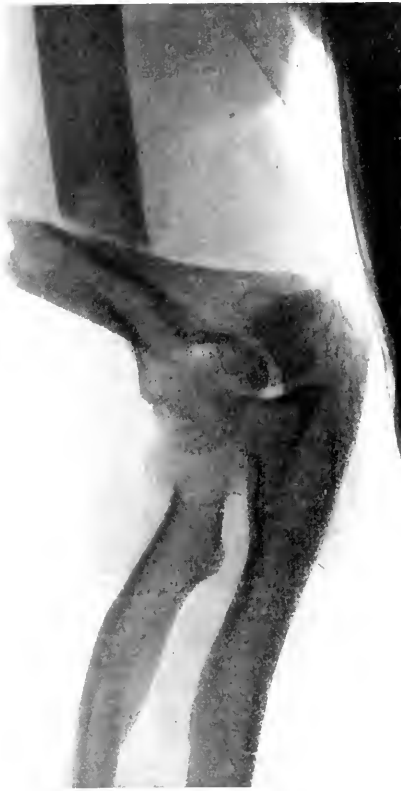

FIG. 135.—Fracture of shaft of humerus ; rotation of lower fragment and elbow-joint.



FIG. 136.—Fracture through external condyle with forward and upward displacement of the fragment of bone. The presence of chronic arthritic changes in the joint indicates that the injury is one of some standing. The radiograph was taken many months after the primary injury.

is always due to blows upon the shoulder, never to direct violence. It is evidenced by signs of a severe local trauma, with loss of mobility of the arm. The head of the humerus is found to be irregular in shape on examination from the axilla, and the fragment, if detached, may be felt. Crepitus is obtained on moving the arm, and there is slight shortening.

(b) Fracture through the *surgical neck*. This is a common injury. There may or may not be a considerable degree of displacement, or the lower point of the bone may be impacted into the upper; the latter may be partially split.

(c) The *great tuberosity* of the humerus is frequently detached and displaced.

(d) The *epiphysis* of the head may be detached from the shaft, and there may be a considerable degree of displacement.

**Fracture of the Shaft of the Humerus.**—This bone is frequently fractured, and the injury may occur at any part of its length. The most common injury is about the junction of the upper with the middle third. The displacement may be considerable. An unusual displacement is shown in Fig. 135, a transverse fracture with marked rotation of the elbow-joint inwards; the lower fragment of the humerus is nearly at right angles to the upper. The head of the radius appears to have been injured.



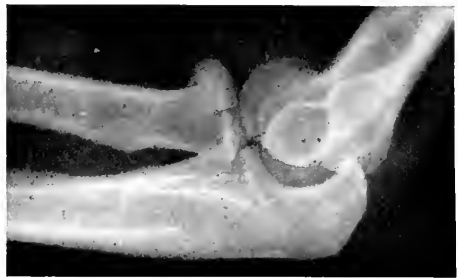
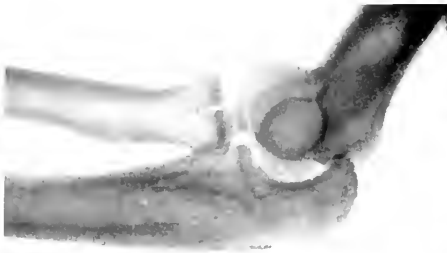

PLATE XII. FRACTURES IN REGION OF ELBOW-JOINT.

- a*, Vertical fracture of head of radius.
- b*, Fracture through head of radius, displacement forwards of fragment.
- c*, Fracture through lower end of humerus above epiphyseal line, displacement backwards.
- d*, Fracture dislocation at elbow-joint.

## Injuries in the Region of the Elbow-joint

**Fracture of the Lower End of the Humerus.**—The humerus is frequently involved in injuries of the elbow-joint in adults and in children. It gives rise to a typical displacement, which is clearly revealed upon examination of the radiographs obtained. The displacement varies with the direction of the injury. The lower end, along with the elbow-joint, may be displaced backwards, while there may also be some lateral displacement and rotation. Stereoscopic radiographs are extremely useful in these cases.

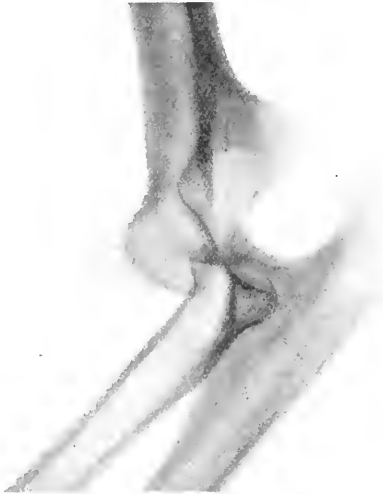

FIG. 137.—Dislocation of elbow-joint.

**Separation of the Epiphysis** of the lower end of the humerus is a common injury in this region. It is very difficult to show in children, and requires more careful examination than any other injury.

**Dislocations of the Elbow-joint** are common, and frequently combined with fracture in the region.

**Fracture of the Olecranon** may be complete or incomplete. It is commonly a transverse fracture, though it may be oblique or vertical, or the upper portion may be shattered. The displacement varies with the extent of the fracture.

**Fracture of the Coronoid** is a rare injury. It is generally associated with a dislocation of the forearm backwards. When the fracture is reduced, the bones tend to slip out again readily.

**Fracture of the Head of the Radius** is by no means an uncommon injury; it may be complete or incomplete.



FIG. 138.—Fractures through shafts of radius and ulna. The position of both bones is faulty. There is also a fracture through the lower end of the radius.

## Fracture of the Shaft of the Radius and Ulna

One or other of the bones may be broken. The usual seat of injury is near the middle of the shaft, in which case both bones are frequently broken,



FIG. 139.—Fracture of shaft of ulna (the result of a gunshot wound).

and the displacement may be considerable. One or other bone may be involved in injuries at the elbow-joint or wrist-joint.

## Injuries at the Wrist-joint

Fracture of the lower end of the radius and ulna is included in the description of the common Colles fracture. The results of the analysis of a large number of cases of fracture at the wrist-joint investigated by Dr. R. W. A. Salmond and the author may be quoted (*Lancet*, Nov. 2, 1912).

(a) *The Radius*.—This shows injury in 93 per cent. of the total number of cases. The large percentage is without doubt due to the important part the lower end of this bone takes in the mechanism of the wrist-joint. Most injuries at the wrist are carried up from the hand and are transmitted through the radius, hence the great frequency of damage to the lower end of the bone. The radius alone is injured in 41 per cent. of the total number of cases, showing that, while

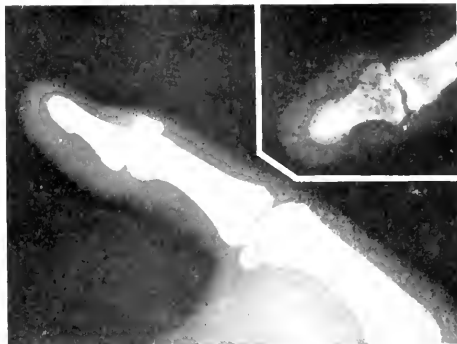

PLATE XIII. - FRACTURES IN FOREARM, WRIST, AND HAND.

- a*, Fracture of terminal phalanx of thumb, backward displacement. Lateral and antero-posterior views.
- b*, Fracture of trapezium.
- c*, Fracture through lower end of shaft of radius, very little displacement.
- d*, Non-union fracture of radius and ulna, formation of false joints.



PLATE XIV. FRACTURES AT WRIST-JOINT.

Fracture of lower end of radius. *a*, Lateral view showing displacement. *b*, Antero-posterior view showing nature of fracture.

*c*, Antero-posterior view of separated epiphysis of lower end of radius. *d*, Lateral view to show displacement.

*e*, Fracture through lower end of radius. *f*, Colles fracture, antero-posterior view.



it is injured in nearly every case, the injury is more often distributed to some of the other bones than confined to itself.

The radius is injured along with the styloid process of the ulna in 42 per cent. of the total number of cases.

The radius is damaged, together with the shaft and the styloid of the ulna, in 3 per cent. of cases. This is therefore infrequent, and the more so as the majority of the instances are due to a fracture carried up from the damaged styloid process into the shaft of the ulna. The frequency of injuries to the radius and the shaft of the ulna is also low—namely, 3 per cent. It will be noticed how much more frequently the radius is injured with the styloid of the ulna than with the shaft, and it is interesting to compare this with the corresponding injury in the un-united epiphyses series. Injury is confined to the radius and carpus in 4 per cent. of cases.

*Direction of Injury.*—The great majority are transverse, 67 per cent.; T-shaped in 16 per cent.; fracture from the centre of the lower end across the styloid process, 8 per cent.; V-shaped, 4 per cent.; fracture of styloid process, 3 per cent.; oblique, 2 per cent.; longitudinal, 2 per cent.; and injury at the inferior radio-ulnar articulation, about 1 per cent. Where the shafts of both forearm bones are injured the direction in the radius is transverse in all the cases examined.

*Position of Injury.*—By far the commonest is half an inch above the lower end of the bone. It is striking that 99 per cent. of the injuries recorded are three-quarters of an inch or less from the lower end.

*Displacement of Fragment.*—This is backward in 74 per cent., forward in 2 per cent., and there is none in 24 per cent., but most of the cases examined had been manipulated by the surgeon, so displacement is more or less misleading. Outward and inward rotation and displacements are not recorded, as many of the cases showed rotation, chiefly outwards, but it was often difficult to decide which to include and which not.

(b) *The Ulna.*—Some part of this is injured in 49 per cent. of the total number of cases, about one-half the frequency of the radius. Injury to the styloid process occurs in 46 per cent. of the total number of cases, so that by far the commonest injury to this bone in this series is here. It is interesting to contrast the frequencies with which the styloid processes of the ulna and radius are damaged. In the former 46 per cent. and in the latter 3 per cent. show fracture of these processes, and we think the explanation is due partly to the styloid of the radius being structurally stronger than that of the ulna, partly because, the fragment of the radius being most commonly displaced backwards and rotated outwards, the internal lateral ligament attached to the apex of the ulnar styloid is put on the stretch, and must either rupture or exert tension on that process, while at the same time, with the fragment of the radius rotated outwards, the interarticular fibro-cartilage attached to the base of the ulnar styloid pulls on that base and helps to damage it.

*Direction of Injury.*—There is no tendency towards any one type, nor is there any predominant type in this bone when the shafts of both forearm bones are damaged. That no tendency has been noted is perhaps because the injury is relatively rare and a sufficient number of cases has not been examined.

*Position of Injury.*—All are within 2 inches of the lower end, and so, on the whole, extend further up the shaft than in the radius. As would be expected, the majority are at the styloid process, 91 per cent.

*Displacement of Fragment of the Shaft.*—This is chiefly backwards, as in the radius, though, owing to a fracture in some cases being continued up from the styloid process, the frequency with no displacement is also high.

(c) *The Carpal Bones.*—Injury is present in one or more of these in 13 per cent. of the total number of cases. This proves how frequently these are damaged in wrist injuries, and probably the frequency is even greater, as only undoubted cases of injury are included. The carpus without either of the forearm bones is injured in 5 per cent. of cases, the carpus and radius in 4 per cent., and in none is the carpus injured with the ulna only, showing that the ulna does not directly take part in the mechanism of the wrist-joint. The carpus, radius, and ulna are together injured in 3 per cent. of cases. The scaphoid is the one most frequently damaged, no less than thirteen times out of nineteen. Next in order is the trapezium, while the carpal bones towards the ulnar side are less frequently involved.

## Fractures of the Bones of the Hand

**Fracture of the Carpal Bones.**—Any of these may be fractured, examples being met with in routine examination.

**Fractures of the Metacarpal Bones** are common. Perhaps the most frequently met with is that of the base of the first metacarpal, Bennet's fracture. Plate XV., fig. *d* illustrates the nature of the fracture and the displacement commonly met with.

**Fractures of the Phalanges** are also common. There may be no displacement in some fractures. The diagnosis can be made by a screen examination, but even with these small bones it is always well to confirm the diagnosis by taking a radiograph. A negative diagnosis should never be made on the screen examination alone.

## Fractures of the Pelvis

The pelvis is often injured by direct or indirect violence. A radiograph should be taken of the whole pelvis in one picture, or several smaller ones may be taken to discover the nature of the injury.

The iliac bones may be fractured, when it is sometimes difficult to show the seat of the lesion. When the sacrum is damaged, there may be a fracture at the sacro-iliac synchondrosis, and the body of the sacrum may also be involved in these injuries. The pelvis is often damaged when the violence is of a crushing type, or it may be broken by direct violence. The ischium may also participate in the injury. The coccyx is frequently fractured.

In all doubtful cases both sides of the pelvis should be examined, and the hip-joints should also receive attention. The common injuries are easily distinguished, but there are many grades of fracture, where the injury may not be demonstrable if only one radiograph be taken.

## Injuries near the Hip-joint

In some cases of injury at the hip-joint a widening of the interarticular space may indicate an **effusion of blood** into the joint, which later on may lead to inflammatory changes and abscess formation.



PLATE XV.—FRACTURES OF WRIST AND HAND.

*a*, Normal adult hand. *b*, Displaced epiphysis of lower end of radius which has been wired. *c*, Fracture through base of metacarpal bone of thumb. Note character of the displacement. *d*, Oblique fracture of shaft of metacarpal bone of little finger.



An uncommon injury to the hip-joint has been recorded, where the head of the bone was driven through the **acetabulum** into the pelvic cavity. Or the acetabulum may be fractured to a lesser degree. This may be shown on examination.

**The Neck of the Femur** is frequently broken when, especially in old people, there may be impaction. Traumatic coxa vara is a fairly common occurrence.

**Fracture through the Great Trochanter** is also common. It may be localised to the trochanter or may extend downwards obliquely into the shaft.

### Fractures of the Femur

**Fracture through the Shaft** below the lesser trochanter is an injury often met with.

#### Fractures of the Lower End.

— (1) *Transverse supra-condyloid fracture* is practically identical with that involving the lower third of the femur.

(2) *T- or Y-shaped fracture* of the condyles. In this a transverse fracture is complicated by a fissure which runs into the joint, separating the two condyles.

(3) *Separation of either condyle* always results from direct violence, the line of fracture being oblique.

(4) *The lower epiphysis* of the femur is separated from the shaft in young people.

(5) *Longitudinal and spiral fractures* running down to the knee-joint are met with in the femur.



FIG. 140.—Fracture through shafts of both femora. The fracture is comminuted on the left side.

### Fractures of the Patella

These may vary from mere fissures to complete fracture with wide separation at the line of fracture. The partial fracture is the one which it is most important to recognise. A lateral view of the knee-joint is the most useful position in which to radiograph the joint for its recognition.

### Fractures of the Bones of the Leg

The tibia and fibula may be involved when there is a fracture of the lower end of the femur; they may be broken together or either bone by

itself. Fractures of the shaft of the tibia and fibula may vary from a fine crack to a marked degree of fracture, with displacement of the fragments. The tibia is frequently the seat of a spiral fracture. The fibula only may be fractured, when there is no marked displacement or external sign of fracture.

### Fractures in the Neighbourhood of the Ankle-joint

These are usually produced by indirect violence. There may be marked displacement of the foot.

**Pott's Fracture.**—The fibula is generally broken, three inches above the tip of the external malleolus, and the foot is displaced outwards. The internal malleolus may also be broken, with fracture of the lower end of the fibula, or it alone may be broken.



FIG. 141. —Fracture of os calcis (gunshot wound).

**Fracture of the Os Calcis** is a comparatively common injury, the result of direct violence. The degree of damage to the bone varies from a crack to a severe crushing of the bone.

**Fracture of the Astragalus.**—The lesion is often a severe, comminuted one. Both bones may be broken when a patient lands heavily on both feet; and these

fractures are often associated with fracture of other bones of the foot. Any of the tarsal bones may be fractured. The extent of the injury is often difficult to determine. It may be merely a crushing of the bone, in which case it is not easy to distinguish the injury from changes which are the result of disease, or there may be a distinct line of separation.

The metatarsal bones are frequently involved in injuries to the foot. Fractures may be transverse or longitudinal. Fissured fracture of the bone is not uncommon.

The phalanges are also frequently injured. Two positions of the foot should always be taken when looking for fractures. Stereoscopic pictures are very helpful in doubtful cases.



PLATE XVI. NORMAL HIP, DISLOCATION, AND FRACTURE AT HIP-JOINT.

- a*, Normal hip-joint, showing the head of the femur : the acetabulum is seen surrounding part of the head.  
*b*, Dislocation at hip-joint.  
*c*, Fracture through neck of femur (intracapsular).

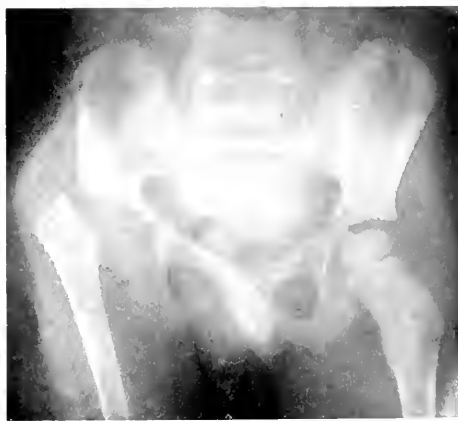

PLATE XVII.—INJURIES AND DISEASE OF PELVIS AND HIP-JOINT.

*a.* Fracture of pelvis in a child: the injury has occurred at both pubic bones, and on one side through the ischium.

*b.* Fracture of neck of femur, impaction into great trochanter.

*c.* Displacement of upper end of femur in a child. The acetabulum is eroded and the head of femur is absent. This is probably the result of tuberculosis. The appearances are similar to those of congenital dislocation.



## DISEASES OF BONE

All varieties of bone disease are met with in the radiographic examination of the bones, it being possible to trace the progress of disease from the slightest beginnings to the most advanced stages. A thorough appreciation of the normal appearance of bone is necessary before we can make out departures from it. Good negatives are essential, that is, the negative must show the finer detail as well as the outline of the bone. Soft tubes give better plates for this purpose than hard ones, but the exposures require to be longer, and this is in some cases a disadvantage, as movement on the part of the patient is apt to spoil the picture. When a long exposure is necessary the limb may be kept quite still by laying sand-bags around it and upon the parts not required in the picture, or soft pads may be placed on the limb, and a compression apparatus fixed lightly down upon them. The use of a cylindrical diaphragm seems to give sharper radiographs by cutting off the secondary radiations. When practicable it is better to place the X-ray tube as far away from the plate as possible, a distance of three feet (or more) giving the parts with less distortion. When a particular bone has to be examined it is a good plan to get the corresponding one on the healthy side for comparison, taking care that both bones are radiographed under the same conditions of tube and distance.

A brief consideration of the pathology of bone is necessary in order to understand clearly the various conditions met with in the course of examination of bone disease. Many different terms are applied more or less loosely to the pathological processes, and much confusion is introduced thereby.

**Necrosis.**—Necrosis or death of bone may occur in a variety of forms, and from many different causes :

(1) Acute localised suppurative periostitis, the sequestrum or dead mass being then simply a superficial plate or flake of the compact interior.

(2) Acute infective osteomyelitis, the sequestrum then often involving the whole thickness of the bone, and invading more or less of the diaphysis.

(3) Acute septic osteomyelitis, usually traumatic in origin, the sequestrum being annular in shape, and involving more of the interior of the bone than the exterior.

(4) Acute or subacute septic osteitis of cancellous bone, the sequestrum consisting of small spiculated fragments of the bony cancelli which have escaped absorption by the granulation tissue which always forms in such a process.

(5) Tuberculous disease of cancellous tissue, the sequestrum being light and porous, often infiltrated with curdy material, and rarely separated completely from the surrounding parts.

(6) Syphilitic disease of cancellous or compact bone, usually resulting from excessive sclerosis, or gummatous disease of the periosteum, which has become septic.

(7) The action of local irritants, *e.g.* mercury and phosphorus.

**Caries.**—(1) Osteoporosis, or rarefaction of bone, a clinical condition resulting from inflammation, and consisting of a soft and spongy condition of the bone.

(2) Caries sicca, when the process occurs without suppuration.

(3) Caries suppurativa, when pus is always present.

(4) Caries fungosa, when granulation tissue is always in excess, especially in tuberculous disease of the articular ends of bones.

(5) Caries necrotica.—Necrosis is associated with caries, the sequestra consisting of spiculated fragments, or in tuberculous disease of larger masses.

**Sclerosis of Bone** is usually the result of some chronic inflammatory infection :

(a) Chronic periostitis, whether simple or syphilitic.

(b) Chronic osteomyelitis, simple, tuberculous, or syphilitic.

(c) Chronic osteitis of the compact bone, which is always secondary to a case of the former.

## Classification of Inflammatory Affections of Bone

**(1) Periostitis.**—(a) Acute localised, with or without suppuration.

(b) Acute diffuse, always associated with, or secondary to, acute infective osteomyelitis.

(c) Chronic simple, or hyperplastic.

(d) Chronic tuberculous.

(e) Chronic syphilitic.

**(2) Osteitis of Compact Bone,** which is always associated with, and secondary to, either periostitis or osteomyelitis, and so will not be described separately. The acute form results in necrosis, the subacute in osteoporosis, and the chronic in sclerosis, except in tuberculous disease.

**(3) Osteomyelitis,** or inflammation of the medulla of long bones.

(a) Acute septic (traumatic).

(b) Acute infective (idiopathic), acute panostitis.

(c) Subacute simple or infective, *e.g.* after fractures, or during the separation of sequestra, resulting primarily in rarefaction, but finally in sclerosis.

(d) Chronic simple, tuberculous or syphilitic, usually causing general enlargement and sclerosis of the bone, even if locally some rarefaction is present.

**(4) Osteitis of the Cancellous Tissue** may similarly be :

(a) Acute septic, or traumatic.



PLATE XVIII. INJURIES AT KNEE-JOINT.

*a*, Knee-joint showing epiphyses, chronic inflammatory changes at epiphyses of femur (Schlatzer's disease). *b*, Fracture of patella, fragments widely separated. *c*, Fracture of lower end of femur. *d*, Fracture of lower edge of patella.

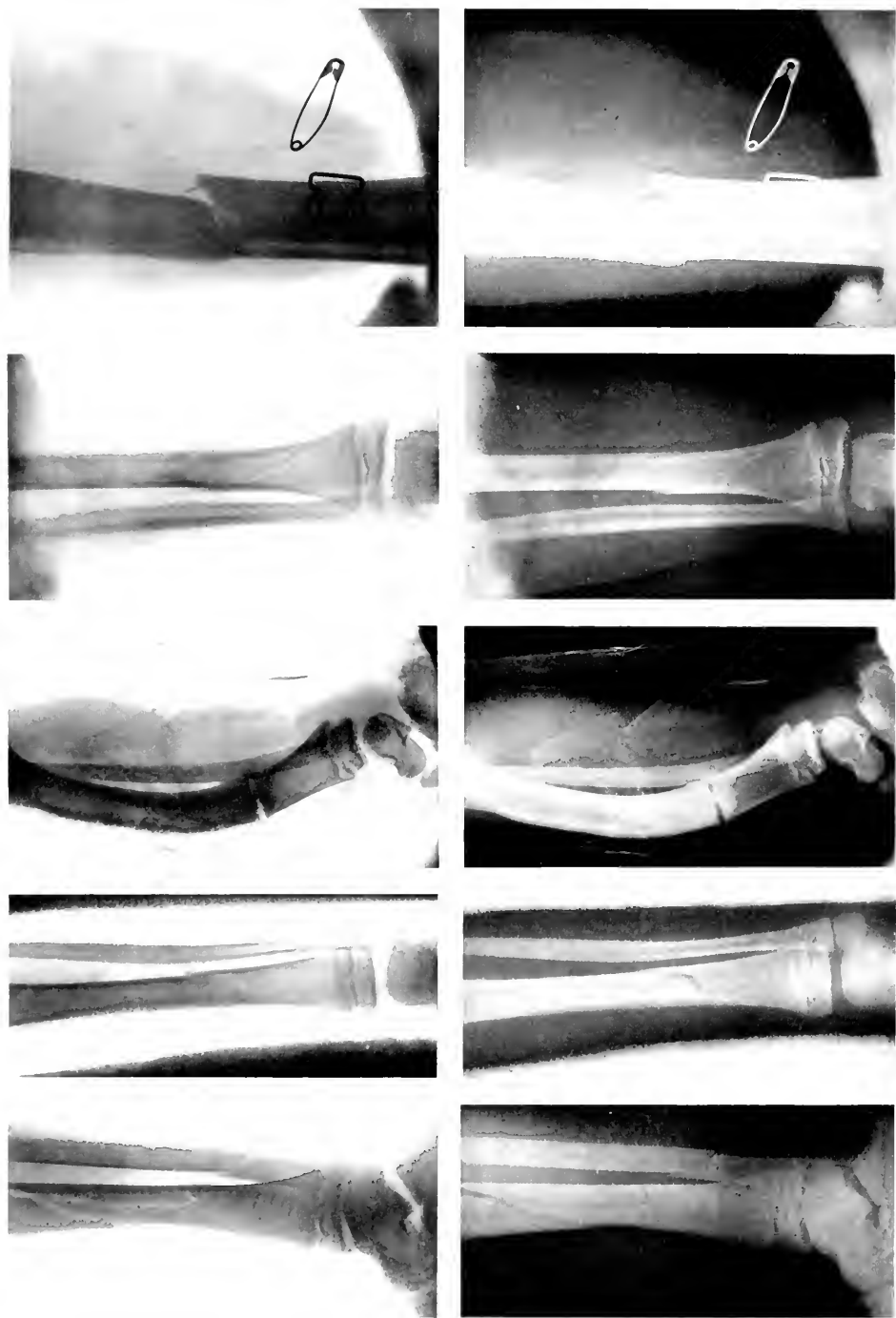

PLATE XIX.—FRACTURES OF BONES OF LEG.

*a*, Spiral fracture through tibia, transverse fracture of shaft of fibula. *b*, Oblique fracture of shaft of tibia. *c*, Transverse fracture through shaft of tibia, note curve of tibia (rickets). *d*, Oblique fracture through shaft of tibia; in this position it is very difficult to detect the fracture. *e*, Fracture through shaft of tibia with antero-posterior displacement; note calcaneus posterior tibial artery.



PLATE XX. FRACTURES AT THE ANKLE-JOINT.

- a*, Oblique fracture through lower end of fibula. — *a* Lateral. — *b* Antero-posterior views.  
*b*, Fracture of internal and external malleoli, displacement of foot outwards at ankle-joint.  
*c*, Fracture of astragalus. — *d*, Fracture dislocation at ankle-joint.  
*c*, Fracture lower end of fibula.



PLATE XXI. FRACTURES OF LEG, ANKLE, AND FOOT.

*a.* Oblique fracture of shaft of tibia, lateral view, shows epiphyses of lower end of tibia and also of os calcis.

*b.* Antero-posterior view of tibia and fibula, showing an oblique fracture of shaft of tibia; and also epiphyses at lower end of tibia and fibula.

*c.* Fracture through shaft of tibia; the bone is rarefied and is probably the seat of secondary carcinoma.

*d.* Fracture of lower end of tibia and fibula, forward dislocation of tibia.

*e.* Fractures of tibia and fibula.

*f.* Fracture of base of second and third metatarsal bone.

(b) Acute infective.

(c) Subacute simple or septic.

(d) Chronic simple, syphilitic, or tuberculous.

When limited to the articular end of a bone in a young person, this is sometimes termed epiphysitis.

**Acute Localised Periostitis** is usually the result of traumatism. It may end in an inflammatory swelling of the surface of the bone, which later may cause a superficial abscess. A thickening of the soft parts over the bone may be shown. Resolution may follow this, and a localised thickening at the seat of inflammation may remain for some time. If suppuration occurs and pus forms, it may be possible to demonstrate its presence radiographically.

*Superficial Necrosis.*—This is characterised by the separation of small particles of dead bone. New bone may be thrown out around the inflamed area, and leave evidence in the form of layers of more or less dense bone.

**Acute Infective Osteomyelitis.**—Acute necrosis occurs generally in children of low vitality, often of tubercular inheritance. The early manifestations of this disease are often extremely slight. A hardly perceptible inflammatory process in the neighbourhood of the epiphyseal line or near a joint rapidly spreads, involving the whole diaphysis of the bone. A subperiosteal abscess may form, while the central portion of the bone escapes almost entirely. Should the process commence in the vicinity of the epiphyseal line it may spread in several directions, may involve the medullary cavity, and give rise to the most typical form of osteomyelitis. Necrosis follows, usually implicating the whole thickness of the medullary cavity and diaphysis, and sometimes extending its whole length. Occasionally the neighbouring joint becomes involved. The pictures presented by this disease show all stages, from a preliminary inflammatory process, to advanced necrosis, formation of sequestra, and new bone formation. If radiographs are taken at regular intervals, the whole process of inflammation, suppuration, necrosis of bone, sequestra formation, deposit of new bone around the dead bone, and the gradual building up of new bone after operation to remove the sequestra may be followed up.

The pathology of this form of disease of bone may be watched by means of radiography. The demonstration of the presence of free bone in a cavity surrounded by new bone is a guide to the surgeon in the operation as to when and where to operate, and indicates clearly the progress the bone is making in the direction of recovery.

**Acute Septic Osteomyelitis.**—This arises as a result of infection from without, in cases of compound fracture, and after amputation or excision of bone; the shafts of long bones are affected, and the disease generally runs a rapid course.

**Typhoid Osteitis.**—The typhoid bacillus may lie dormant for years without causing any abscess formation. The appearance is typical, and is shown in Fig. 142.

**Chronic Inflammation of Bone.**—Chronic osteo-periostitis, a chronic inflammatory process, results in overgrowth, thickening, and con-

densation, (1) as a localised chronic periostitis, traumatic, rheumatic, or syphilitic in origin: or (2) as a diffuse form, usually tubercular or syphilitic, which tends to involve the whole bone. It may result in a small abscess or central necrosis. Around this focus the bone becomes thick and indented. Examples of this are shown in Plate XXII., figs. *d* and *e*.



FIG. 142.—Typhoid osteitis and periostitis resulting in an abscess.



FIG. 143.—Elbow-joint showing disease. Formation of new bone along shaft of ulna and humerus. Chronic osteitis and periostitis, probably tuberculous in origin.

**Tuberculous Disease of Bone.**—This form of disease of bone is frequently met with in X-ray examinations. Bones may be affected in two ways by tuberculosis. The periosteum or the cancellous tissue may be primarily involved.

*Tuberculous Periostitis*, or specific inflammation of the periosteum, is met with. Caseation and suppuration are likely to follow, frequently leading to the formation of abscesses, and, later, of discharging sinuses. The inflammation may result in a thickening of the layers of bone and a shutting in of the products of suppuration, hence, if situated near a joint, the pus may burrow under the dense bone and invade the joint.

*Tuberculous Osteitis* always arises in cancellous tissue, and it affects the short bones or the shafts or ends of the long bones. The short bones of the hands and feet are liable to this condition, especially in children. When the phalanges are involved the condition is known as tuberculous dactylitis. The typical appearance of this condition is shown in Plate XXVII., fig. *c*. Several bones may be simultaneously affected. Some slight injury may determine the onset of tuberculous periostitis or osteitis.

*Tuberculous Epiphysitis*.—An inflammation affecting primarily the epiphyseal line and adjacent bone. The tendency is for it to spread and involve the joints by the invasion of the synovial membranes. Separation of the epiphysis may result. The adjacent bones show a condition of osteitis and



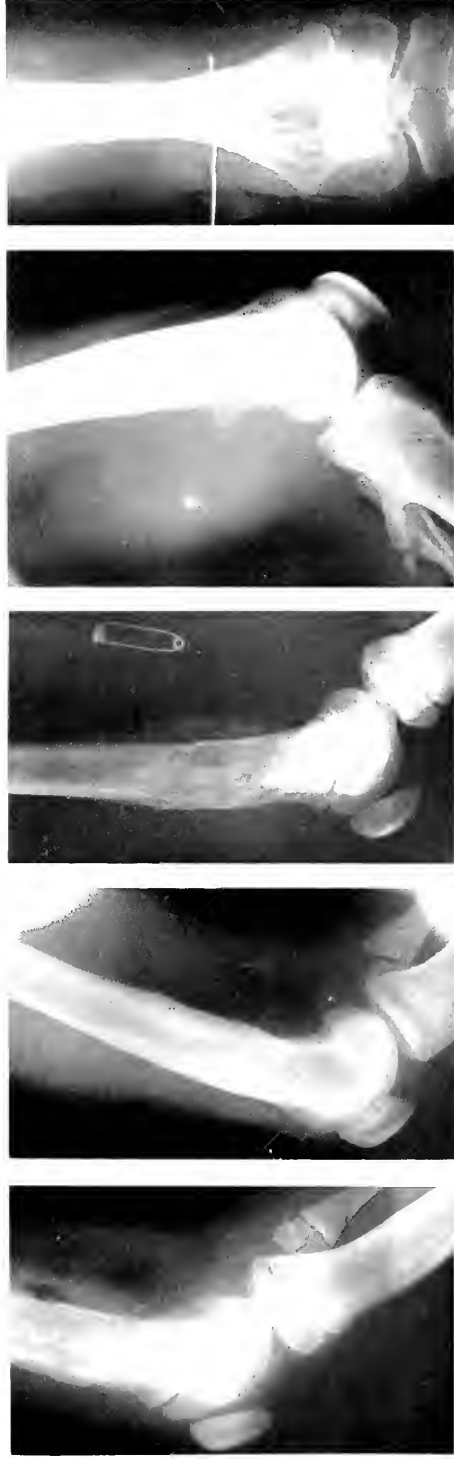

PLATE XXII.—CHRONIC INFLAMMATORY CONDITIONS OF BONES.

*a*, Osteitis of lower end of femur, sequestrum formation. *b*, Osteitis with superficial periostitis. *c*, Osteomyelitis of femur, periostitis with new bone formation. *d*, Osteitis and periostitis with abscess formation in soft parts (traumatic). *e*, Extensive osteitis and periostitis, probe in sinns; lower end of femur.

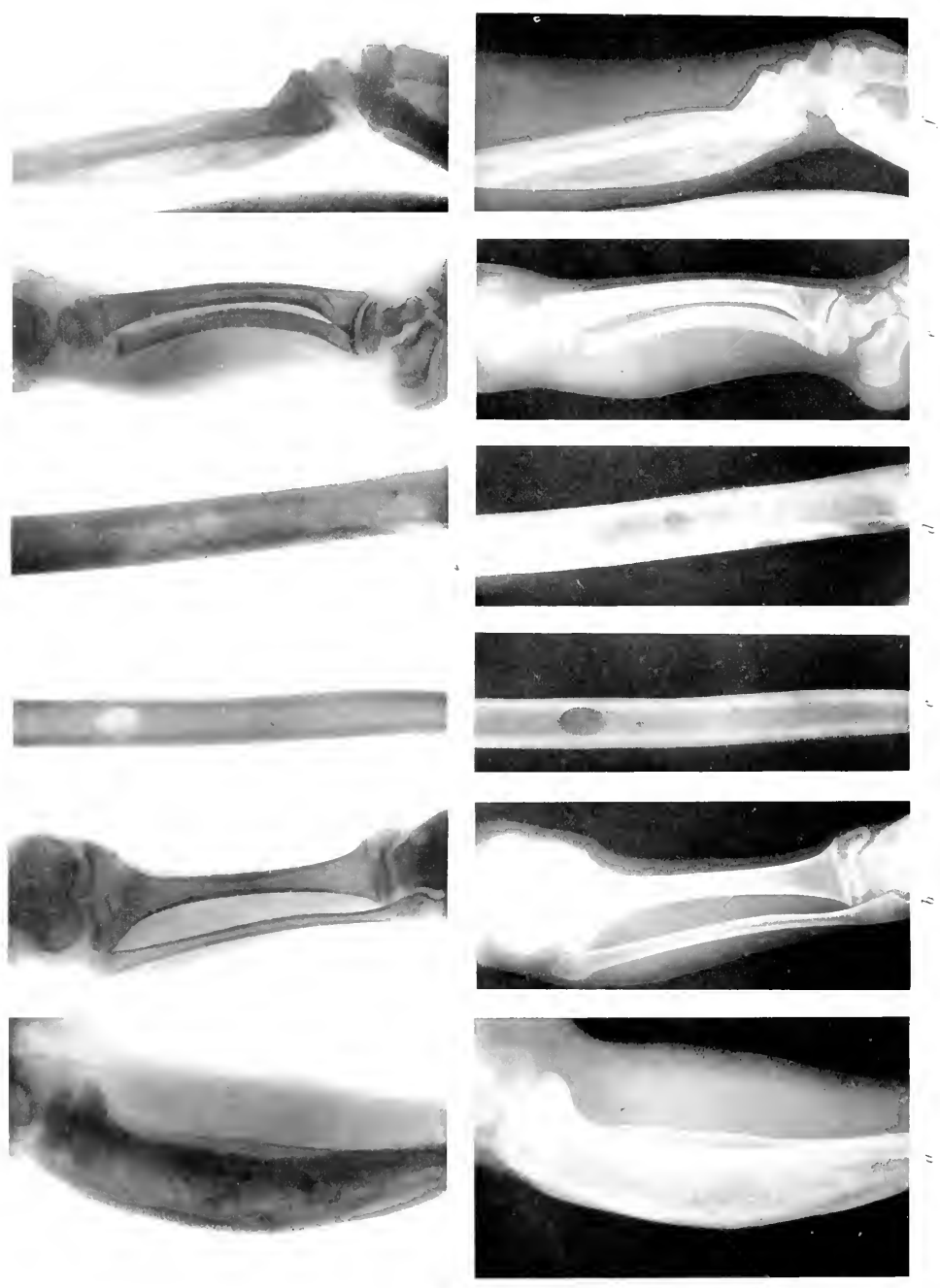

PLATE XXIII.—INFLAMMATORY AND OTHER AFFECTIONS OF BONES.

*a*, Tibia, showing chronic changes in bone (osteitis deformans). *b*, Arrested development at epiphyseal lines, in a patient 34 years of age. *c* and *d*, Changes occurring in long bones from a case of carcinoma mammae, probably secondary deposits. *e*, Curvature of tibia and fibula (rickets). *f*, Chronic osteitis after injury to wrist-joint.

periostitis. Abscess of bone, more common in adults than in children, may result. Chronic abscess in the head of the tibia is somewhat frequent. The characteristic symptom of deep aching pain calls attention to the possibility of bone abscess. The bone around the abscess cavity is frequently very dense, though it varies in this respect in parts of its circumference. Radiographically, the condition may be recognised by an increase in shading and loss of detail in the bone structure on the surface. The periosteal outline is blurred, and may show patches of caries or collections of pus. The soft parts are frequently involved in the inflammatory process, and a soft puffy swelling may be seen over the affected portion of bone. When the disease has advanced, the original focus of disease shows up as a lighter area, with patches of rarefaction of bone leading from it. The fine detail of the bone is lost, and a general haziness is left in its place. Later, when pus has formed, an irregular abscess cavity can be seen, there being as a rule very little condensation of bone round the abscess. Should the cancellous tissue in the neighbourhood of an epiphyseal line be involved, the disease extends through the line, and affects the epiphysis, which shows as a spongy rarefaction with irregular edges. The inflammatory process spreads into the joint itself, and sets up a synovitis, which is characterised by a general distension of the joint and an obscuring of detail.

**Syphilitic Diseases of Bone.**—The osseous tissue may be involved in acquired syphilis in either the secondary or tertiary form. Syphilis of the bone is frequently met with, and it is often difficult to differentiate it from a simple inflammatory process. Chronic thickenings in the form of nodes are diagnostic of *syphilis*. When a considerable extent of bone is involved, it may be difficult to distinguish between this condition and an early stage of malignant disease. In the latter the disease spreads more rapidly, and the characteristic appearances of malignancy manifest themselves. In the tertiary period the bones may participate in the changes which involve any and every tissue of the body. These consist of an infiltration and overgrowth of the connective tissue, which, if diffused through the organs, produce sclerosis, or, if localised to one spot, lead to the formation of a gumma. The *subperiosteal gumma* may be met with. It probably results from caries of the adjacent bone, and if it extends widely an extensive area of bone may become eroded and irregular. The skull is the part most frequently involved in these changes, and may show a curious worm-eaten appearance. The formation of gummata, several of which may break down, gives a curiously uneven appearance to the radiograph of the skull, thickening and enlargement, alternating with broken-down tissue, leading to marked thinning of the bone in places.

*Congenital Syphilis.*—Nodes, known as Parrot's nodes, form on or around the anterior fontanelle. The newly formed bony tissue becomes sclerosed and dense, and deformity may then persist through life. A similar condition is met with in the shafts of the long bones, due to the alternating deposition of lamellæ of soft and hard bone outside the ordinary compact bone.

*Syphilitic Epiphysitis.*—This condition is characterised by enlargement

of the ends of the bones. It is met with in infants, and somewhat resembles rickets, but comes on at an earlier date. The enlargement is situated mainly in the epiphyses, but not uncommonly extends some way along the shaft, thus contrasting forcibly with rickets. The change commences at the zone of calcified cartilage nearest the diaphysis, which becomes friable, thick, and irregular, and may become transformed into granulation tissue as the disease progresses. Later, reparation of the epiphysis may follow. The disease is usually symmetrical and often multiple. A symmetrical overgrowth of the tibia, combined with an anterior curvature, often occurs in syphilitic children, resulting in permanent deformity of the legs.

*Craniotabes*.—A condition characterised by localised absorption of the osseous tissue of the cranium, leaving small areas where the bone is thinned or absent. Radiographically, these are often met with.

**Rickets**.—The chief changes are found in the neighbourhood of the



FIG. 144.—Wrist and hand of child, showing changes in lower end of radius and ulna due to rickets.

epiphyses; the epiphyseal cartilage is enlarged, thickened, and irregular; there is an increase in the cartilaginous elements of the bone, and a delayed ossification; the bones are weaker and less rigid, and become deformed in consequence. The ossifying process is delayed. Changes in the shape of the bones of the head may be detected, and the spine may be affected by kyphosis; the teeth do not erupt till late, and are stunted. Changes in the ribs are produced by enlargement of the costochondrial junctions (beaded ribs), which when present on both sides of the sternum produce what is known as the rickety rosary. The principal changes met with radiographically are at the epiphyseal lines of the long bones and the adjacent joint.

**Achondroplasia**. A curious congenital condition, resembling rickets, in which the growth of the osseous tissue on the shaft side of epiphysis of the long bones of the arm and of the leg is affected, so that the limbs are short and stunted, and the stature correspondingly diminished, although the epiphyses are normal.

**Simple Atrophy of Bone**.—This results from a variety of conditions, quite independent of rarefying inflammation, in which it is a marked feature. It may be congenital, or may be due to :





PLATE XXIV.—TUBERCULAR DISEASE OF THE HIP-JOINT.

*a.* Tubercular disease of hip-joint affecting chiefly the upper part of acetabulum.

*b.* Tubercular disease of hip, absorption of head and greater part of neck, upward displacement of femur. (Radiograph by Dr. Salmon.)

*c.* Later stage of tubercular disease of hip-joint, disorganisation and displacement of head, large abscess on outer side of shaft of femur.

(a) Interference with the epiphysis, as in rickets, or injuries, or as a sequence to tuberculosis or other inflammation, involving the function of the cartilage.

(b) Injury or disease of the nervous system or of peripheral nerves, as tabes dorsalis, syringomyelia, leprosy, etc.

(c) Want of use as in a paralysed or ankylosed limb.

(d) Local pressure, as of a tumour growing within or outside the bone.

(e) A senile change.

These conditions are illustrated in many of the skiagrams showing disease of bone and joints, and attention is called to them as they occur.

**Mollities Ossium or Osteomalacia.**—A condition characterised by the absorption of the osseous substance of the bones, as a result of which softening and rarefaction are produced, followed by bending or spontaneous fracture. Pathologically there is a replacement of the medullary substance by a soft, fibro-cellular tissue, which is exceedingly vascular, and into which hæmorrhage may occur. Attention may be called to this condition when a spontaneous fracture, or fracture from slight violence occurs. The changes in the bone can be shown radiographically.

**Morbid Conditions of Bone which predispose to Fracture.**—It is important to bear well in mind several conditions of bone which predispose to fracture. When fracture from slight violence occurs, suspicion should at once be aroused, and the examination should be conducted on lines which will enable the radiographer to show not only the fracture, but also the condition which has predisposed to it. For this, good negatives are essential. A picture which will show a fracture is often not full of fine detail, without which no opinion on bone disease can be formed. In the same way a screen examination will show a fracture, but an opinion of the bone condition cannot be formed from it. The most usual conditions predisposing to fracture are :

(1) Atrophy of bone. This may be senile, or due to disease, *e.g.* ankylosis of a joint or certain nervous affections.

(2) Fragilitas ossium. This consists in an inherited tendency to spontaneous fracture, occurring in children and adults.

(3) Bone disease, such as tuberculosis, rickets, syphilis, osteo-malacia.

(4) Local bone disease or tumours, such as sarcoma, secondary carcinoma.

A condition which frequently leads to fracture is a cystic condition of bone. Many examples have been shown of late years occurring in the long bones, the humerus being a common seat of this tumour. It is frequently a very slow form of myeloid sarcoma. Elmslie has drawn attention to this cystic disease of bone, and shown several interesting examples.

## DISEASES OF JOINTS

These are numerous, and have characteristics which may often be shown by radiography. A great deal of light has been thrown upon the differential diagnosis of such conditions as tuberculosis of joints, chronic arthritis, gout, and other diseases by the systematic examination of joints at regular intervals during the progress of the disease. The various forms of arthritis may be distinguished one from the other. Acute inflammation of a joint may be shown when the synovial sac is seen fully distended; later the shadows caused by the fluid will become denser when pus forms. The changes in cartilage, especially when the disease is chronic, are seen, and later the bone becomes affected. Radiographically the interspaces between the cartilages are increased when the joint is full of fluid. The opposite limb should also be taken in order to determine departures from the normal.

### Tuberculous Disease of Joints

In this disease the departures from the normal are marked. The synovial membrane is swollen and pulpy. The joint is very much enlarged, this being shown when the joint is radiographed, variations in the density of the shadows of the soft parts indicating an inflammatory change in the synovial membrane. The cartilage becomes eroded, and later the process extends to the bone itself, which may be shown to be eroded. In places irregular thickenings of the bone also occur, and the bone in the vicinity of a joint may be thickened for some distance up the shaft. In the later stages the joint shows marked disintegration, with a synovial cavity filled with caseous material, this showing in the radiograph as faintly marked irregular shading within a greatly swollen joint.

The surrounding bones, especially those below the joint, show atrophic changes. All the bones entering into the joint become affected. All stages in the history of tuberculous disease of joints may be demonstrated by radiography. The very early stages are, however, the most difficult on which to give an opinion, and clinical evidence should always be taken into account when an opinion is required. It is of the utmost importance to be able to determine the presence of early tuberculosis, for on that the future treatment depends. In joints which have been the seat of recent injury, changes due to the injury may be detected, and these may later become the centre of a tuberculous infection. Consequently, when examining joints after injury it is important to be able to distinguish fine changes in the parts.



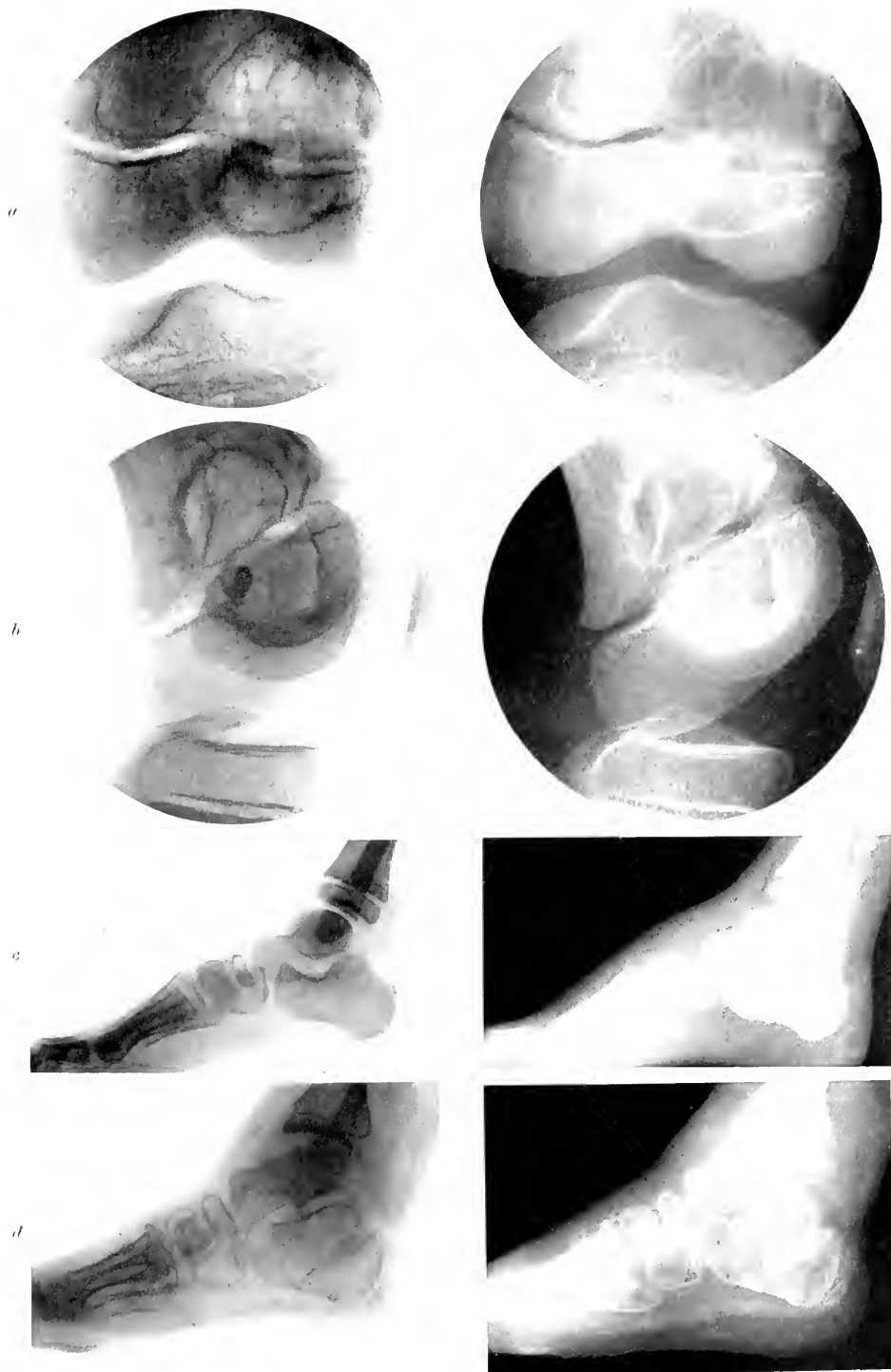

PLATE XXV.—TUBERCULAR DISEASES OF JOINTS.

*a*, Tubercular disease of lower end of femur, involving diaphysis and epiphysis, a considerable degree of sclerosis of bone around an abscess cavity.

*b*, Lateral view showing the same changes. (Radiographs by Dr. R. W. A. Salmon.)

*c*, Tubercular area in scaphoid. (Radiograph by Dr. R. W. A. Salmon.)

*d*, Tubercular disease at ankle-joint; note rarefaction of bones of foot.

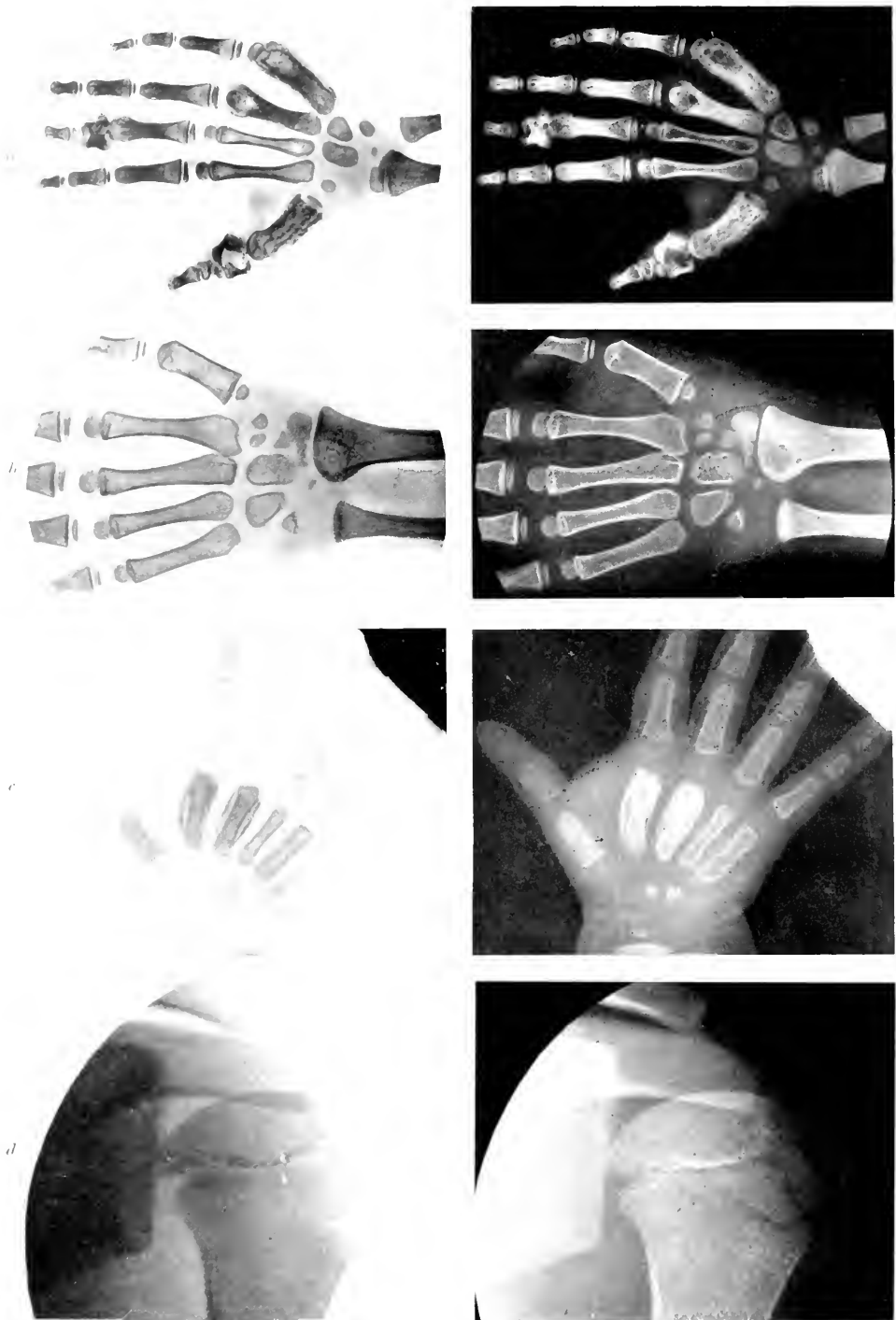

PLATE XXVI.—TUBERCULOSIS OF BONES AND JOINTS.

- a*, Tubercular disease of bones of hand, characterised by new bone formation affecting metacarpal bones and phalanges.
- b*, Tubercular disease at end of radius, localised abscess. (Radiograph by Dr. R. W. A. Salmond.)
- c*, Tubercular dactylitis affecting 2nd and 3rd metacarpal bones.
- d*, Tubercular disease at upper end of humerus (caries sicca). (Radiograph by Dr. R. W. A. Salmond.)

The later stages of tubercular disease are much easier to recognise; rarefaction, caseation, and formation of pus are readily distinguished. A localised rarefaction of bone in the neighbourhood of a joint should arouse suspicion of the presence of pus, particularly when the bone round the rarefied area shows a tendency to condensation. The epiphysis may assume a worm-eaten appearance, which is distinctive of early caries; later this may completely disappear.

It is important also to be able to distinguish between tuberculous and non-tuberculous disease of bone. In acute and subacute osteomyelitis



FIG. 145.—Tuberculosis of left hip-joint, particularly affecting the acetabulum. Note the difference between the two joints and relative shortening of neck on affected side.

affecting the neighbourhood of a joint, and particularly in the latter, the tendency is towards the formation of new bone, and the destructive process is not then so manifest. Irregular thickening of the periosteum with the deposition of new bone favours a diagnosis of non-tubercular disease. In some cases a degree of caries sicca preponderates in the process, and then there is not the same tendency to the formation of an abscess. The bone shows rarefaction for a considerable distance up the shaft. An accompanying degree of rarefaction of the bones entering into the joint results from the restriction of movement, and need not necessarily be taken as an indication of the extent of the disease. Ankylosis of the joint may follow the healing

of the inflammatory process. Displacements of the bones may result from destruction of the ends, in the hip-joint this being frequently shown as a dislocation upwards.

Tuberculosis may be met with in practically any of the joints of the body, those most frequently affected being the hip, the knee, the elbow, the wrist, the ankle, and the shoulder. The appearances are characteristic. The spine is frequently the seat of a tuberculous caries which ends in abscess formation. In many instances the presence of an abscess can readily be

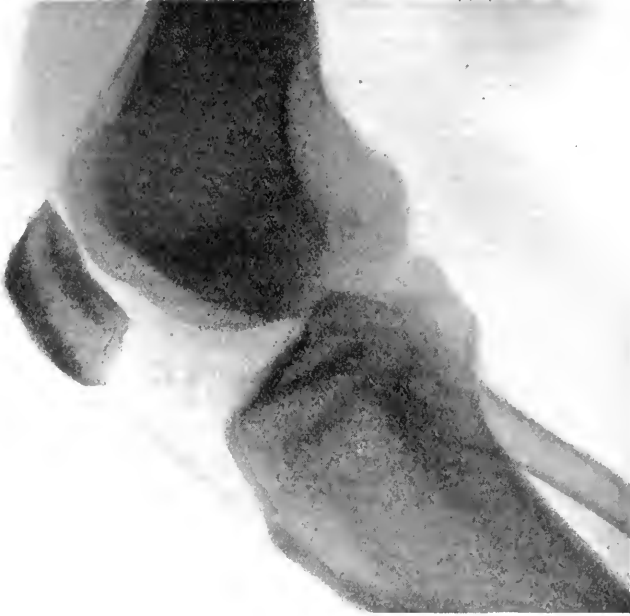

FIG. 146.—Arthritis following injury of knee-joint. Lateral view.

There is a breach in the continuity of the articular surface of the femur. The articular surface of the patella shows slight irregularity. The interarticular space between the femur, head of the tibia, and the patellar ligament is occupied by chronic inflammatory products indicated by a mottled appearance on the print. There is a sesamoid bone in a tendon on the posterior aspect of the joint.

This print shows well the structure of the bones entering into the knee-joint, and the soft parts are very well shown. This quality of negative should always be obtained, if possible, when examining joints for it gives a good definition in all the parts.

shown on radiographic examination. In a later stage a considerable degree of deformity occurs. These are more easily shown. The early stages of a tuberculous inflammation of bone, particularly when the spine is affected, is difficult to distinguish from a tumour involving the spine. A consideration of the history, temperature chart, etc., will help. The tumour shadow is usually more irregular, and generally involves the circumference of the bone, while an abscess may be more localised at one part. In doubtful cases an exploratory operation is to be recommended. Simple inflammatory changes in a joint are commonly the result of traumatism. An acute attack quickly subsides and recovery takes place, but it must be borne in mind that a simple injury may end in chronic inflammation, which may later become the seat of tuber-

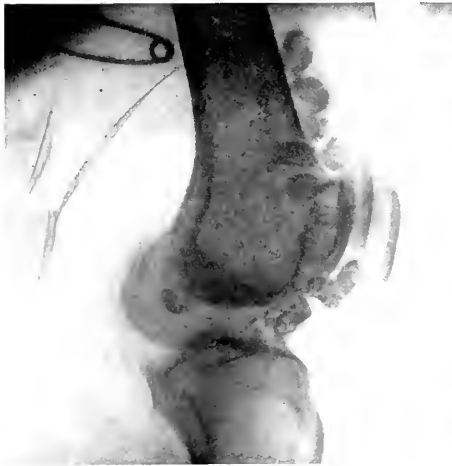

PLATE XXVII.—CHRONIC ARTHRITIC CHANGES AT THE KNEE-JOINT.

- a*, Rheumatoid changes in knee-joint, with large bony deposit in front of femur.
- b*, Chronic rheumatoid changes in knee-joint; loose bodies have formed inside the synovial membrane.
- c*, Knee-joint, showing extensive changes in patella, probably the result of traumatism.



culous invasion. In joints traumatism may lead to minute changes in bone and cartilage which, though not definite enough to be recognised as actual fractures, may yet be quite as serious in their after effects. Ligaments may be torn; this may occur in the knee-joint, when the crucial ligaments are torn. There may even be a fracture of the spine or the tibia. These minute changes should be carefully looked for in all cases of joint injury.

**Atrophy of Bone** may be found in the region of a joint, the result of disease following upon tuberculosis or other inflammatory process.

### Chronic Articular Rheumatism

This affects several of the large joints, especially the knee and shoulder. The hip-joint is also affected. Radiographically, the joints may present very little change and show practically no rarefaction. In very chronic cases there may be some irregularity of outline of the articular surfaces, indicating partial absorption of the cartilage.

### Chronic Articular Gout

The radiographic appearance of the joints may not show much change, except that the articular surfaces may be unusually close together, and lack the rounded appearance they possess when covered with sound cartilage. Deposits of uric acid are occasionally clearly seen in the radiograph, forming a mass denser than the soft parts but not nearly so dense as the bone itself. Fringes of the synovial membrane may become detached and form loose bodies in the joint.

### Loose Bodies in Joints

These are occasionally met with. The following description, which gives the most usual varieties, will be found useful when a consideration of these bodies is called for:

1. Synovial fringes in which proliferation of cartilage cells has occurred, leading to the formation of a nodular mass, which is at first pedunculated, and is then cast off into the cavity of the joint by rupture of the pedicle. These bodies are usually composed mainly of hyaline cartilage, with bony material in the centre of the larger ones. They may become ossified throughout. They vary in size from about  $\frac{1}{4}$ -inch diameter up to 1 inch; the larger ones are usually longer than they are broad. There may be only one loose body in the joint, or there may be several hundreds. It is not uncommon to find one body quite loose, and one or more still attached to the synovial membrane of the same joint.

2. Osteophytic outgrowths from the edge of the articular cartilage may become detached, and so form a loose body in the joint. These bodies are irregular in shape, and usually consist of a layer of cartilage covering an osseous centre.

Varieties 1 and 2 usually occur in cases of osteoarthritis.

3. A portion of articular cartilage with a thin layer of bone may become separated from the femoral condyle, and form a loose body in the joint cavity. This occurs probably as a result of injury.

4. A blood-clot in the joint may become gradually smaller and firmer, and so form a loose body. This occurs as a result of injury.

5. A portion of the synovial membrane may become thickened and indurated as a result of injury. This is nipped by the articular surfaces during the movements of the joint, and finally, as a result of the rupture of the pedicle, the body becomes loose.

6. In tuberculous disease of a joint one or several loose bodies may be found. These are composed of tuberculous material in the thickened synovial membrane.

7. Around a foreign body, such as the end of a needle, fibrous tissue may be formed. This and the preceding type of loose body are rare.

8. Partial detachment of a semilunar cartilage gives rise to a body which hangs into the joint. As this is usually still attached to the bone it cannot be said that it is a true loose body. It, however, gives rise to symptoms of a loose body in the joint.

9. An innocent tumour, such as a lipoma, may form in the synovial membrane, become pedunculated, and so hang into the joint cavity. This is very rare.

10. A foreign body, such as a nail, bullet, or needle, may in rare instances form a variety of loose body in the joint. These, however, are usually spoken of as "foreign" bodies.

## **Rheumatoid Arthritis or Rheumatic Gout**

This is characterised by marked deformity in a typical case. Radiographically, the articular ends of the bones present the normal degree of translucency, or they may be more translucent, but there are irregular, knob-like projections, some of which appear more transparent. The joints may become ankylosed, and there is then continuous bony structure right through the joint.

## **Hypertrophic Arthritis or Osteoarthritis**

This is a condition described separately, but it is probably a variety of the preceding types, characterised by a tendency to the formation of new tissue between bone and articular cartilage, which becomes calcified. There may be marked disorganisation of the bones.

## **Charcot's Joints**

This is characterised by marked enlargement of the joint. The cartilages are eroded, and osseous deposits occur in the ligaments, with irregular outgrowths of bone around the joint.





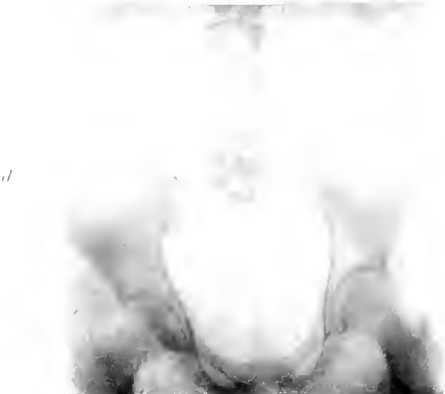
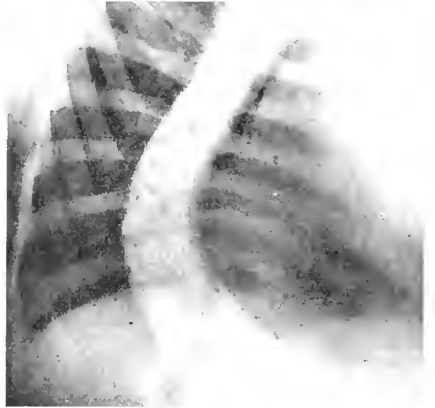
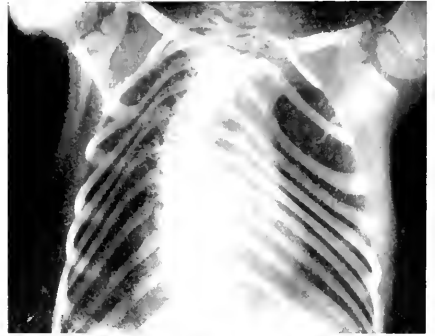
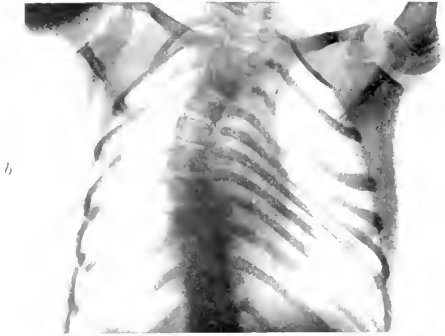

PLATE XXVIII.—DISEASES AND CURVATURE OF THE SPINE.

- a.* Caries of cervical vertebrae, lateral view.
- b.* Curvature of upper dorsal spine (scoliosis).
- c.* Curvature of spine, involving lower dorsal and lumbar vertebrae.
- d.* Caries of lumbar vertebrae and sacrum.

## DIFFERENTIAL X-RAY DIAGNOSIS IN DISEASES OF BONES AND JOINTS

It is important to be able to suggest, if only tentatively, a differential diagnosis in morbid conditions of bone, and, when the disease is near a joint, also of the condition of the joint. The tumours of bone most likely to complicate a diagnosis are (1) sarcoma, (2) cancer. The latter is generally accompanied by a primary lesion elsewhere, but the former frequently arises primarily in the periosteum (periosteal sarcoma) or in the substance of the bone (endosteal sarcoma).

It is necessary to consider the appearances presented by tumours of bone when dealing with what appears to be an inflammatory condition. The subject will be dealt with more fully later. Tumour of bone may be complicated by superadded inflammatory changes which lead to still greater difficulties in diagnosis.

Sarcoma usually attacks the shaft of the bone, and produces changes similar to those caused by certain degrees of osteomyelitis, differing, however, in that the latter show a more pronounced degree of periosteal reaction, as indicated by the deposition of new bone and the tendency to formation of sequestra. In medullary sarcoma certain areas of increased density appear which resemble spiculæ or islands of osseous material, and show actual absorption of the bone, with very few or no normal portions of bone remaining about this point. In osteomyelitis, in addition to the more definite thickening of the periosteal shadow, there is a more definite formation of new bone about the necrosed area.

### Appearance of Joints in Tuberculosis

When examining joints for evidence of tuberculosis the following symptoms should be looked for. They are met with in the course of many examinations of these cases. The earliest changes are naturally the most difficult to recognise.

- (1) Marked porosity of the bones forming the affected joint.
- (2) Actual loss of substance in the head, *e.g.* of the femur.
- (3) Actual loss of substance in the hollow bone, *e.g.* the acetabulum.
- (4) Extreme atrophy of the shaft of the bone.
- (5) Abscess formation, characterised by an increase of the normal

shadow of soft parts around the joint, accentuation and bulging of the joint outline.

(6) Necrosis of portions of the bones, with formation of sequestra.

(7) Arrested development of epiphysis, and changes at epiphyseal line.

(8) Displacement of bones, particularly at hip-joint. Where the head or neck of the femur is displaced upwards this indicates that there is a marked change in the acetabulum.

(9) Ankylosis of the bones forming the joint.

### **Tubercular Dactylitis**

This is characterised by enlargement of the affected bones, deformity, and destruction of bone tissue. Enlargement of the bone is often accompanied by rearrangement of the structure of the bone. Variations in density give the appearance of cysts in bone, the bone surrounding a rarefied area becoming sclerosed in parts; hence the cystic appearance.

### **Syphilis of Bone**

(1) Periosteal proliferation leads to considerable thickening, irregular in character.

(2) Areas of increased rarefaction due to marked absorption of the lime salts, with an effort towards new bone formation.

(3) Periostitis leads to many layers of new bone being laid down along the whole length of the bone. Generally multiple, it therefore affects many of the long bones.

In other cases the thickening may be localised, causing areas of dense new bone formation.

### **Syphilitic Dactylitis**

This is characterised by periosteal overgrowth, with little or no apparent disturbance of the bone, the appearance presented by this condition affording a fairly reliable diagnostic point in favour of syphilis.

### **Chronic infective Osteomyelitis**

(1) General infiltration causes a deeper shadow about the bone and joint when the disease appears in the vicinity of the latter.

(2) Periosteal infiltration and overgrowth lead to marked increase of the adjacent bone, and this sclerosed bone appears to be much denser than normal bone, and the shadow is greatly increased in area.



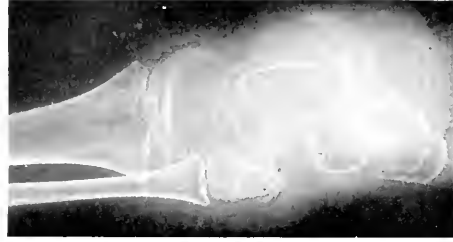
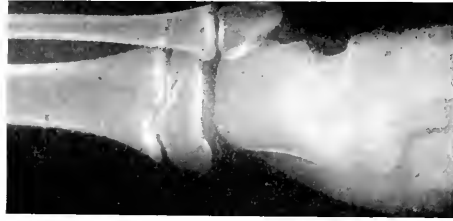
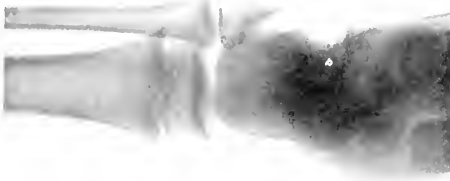

PLATE XXIX. TUBERCULOSIS OF BONES AND JOINTS.

*a*, Early tubercle of knee-joint, distension of joint and changes in condyle of femur. *b*, Later stage of tuberculous of knee, lateral view. *c*, Antero-posterior view, showing considerable destruction of epiphysis of femur. *d*, Normal ankle-joint for comparison with *e*. *e*, Ankle-joint showing extensive tuberculous. Note changes in epiphysis of tibia, and absorption of bony salts in other bones.

## Acute Osteomyelitis

The earliest X-ray appearance of an osteomyelitis, which may run through all the stages of the disease in a few weeks, may be an area of rarefaction at the epiphyseal line, commencing in the diaphysis, and later in some cases extending into and involving the epiphysis. This is followed by periosteal thickening, necrosis of bone, evidenced by areas of varying density, indicating sequestra. The disease may become localised, when radiographically it is shown by an area of lighter shading surrounded by a periphery of denser bone. The condition may arise near the epiphyseal line. Abscess of bone may be the result of the inflammatory process, a typical instance being the well-known abscess in the upper end of the tibia or lower end of the femur.

In the hip-joint a mixed infective process may give rise to appearances which have to be differentiated from tuberculous cases. Though the appearances may indicate a preponderance of evidence in favour of one or other of these diseases, it is not always possible to distinguish between them. A condition where there is a tendency to proliferation of periosteum, thickening of bone and osteophytic outgrowth is more in favour of a non-tuberculous condition. It must not be overlooked, however, that a condition which commenced as a tuberculous one may become the seat of a mixed infection or *vice versa*. An infective area of inflammation may become the seat of a subsequent tuberculous lesion. Marked evidence of bone disease in the vicinity of, but not involving, a joint, is rather an indication for a diagnosis of a non-tuberculous origin for the disease. A typical case may occur in the upper end of the femur, when an area of lessened shadow (*i.e.* a condition which allows of the readier passage of the rays through the bone substance) is due to a destructive process in the bone, with absorption of the bony salts. This is accompanied by a greatly thickened periosteum. The bone, therefore, appears on examination to be denser in the surrounding areas, in contradistinction to the general rarefaction which is so frequently seen in chronic cases of tuberculosis.

The typical X-ray picture of a case of chronic osteomyelitis in an advanced condition, when the whole of the shaft of a bone has become involved, shows :

(1) Areas of suppuration indicated by patches of varying density, rarefaction of bone, and small collections of debris and pus.

(2) Newly formed periosteal bone, shown by the deposition of successive layers of bone outside the shadows of the original bone or what remains of it.

(3) Necrosis of the cortical bone, indicated by irregular patches of denser shadow, with a well-defined periphery, beyond this being lighter shadows, where the living bone still remains.

Generally these conditions are confined to the shaft of the bone involved, the epiphyses and joints escaping. The earliest X-ray manifestation is shown by a slight increase in the periosteal shadow at one or more spots, a definite swelling of the soft parts, and possibly abscess formation.

## Acute infective Periostitis

The diagnosis by X-rays of an early infection of the periosteum is attained by noting changes, such as thickening and bulging of the periosteum. The outline of the periosteum in normal bone is sharply defined, while in acute inflammatory conditions there is a general haziness of its outline in the affected part, or it may be broken and irregular, exposing the cortex of the bone.

The formation of an abscess is shown by an increased depth of shadow in the neighbouring soft parts. In less acute cases this swelling may be due to inflammatory changes commencing in the periosteum.

## Tumours of Bone

The simple forms of tumour are often diagnosed with ease, but the malignant tumours are frequently the subject of great doubt, both clinically and radiographically. The latter method of examination is often called upon, to decide, if possible, the nature of a doubtful swelling. In all such cases great care must be exercised, and all methods of examination should be employed. To make a positive diagnosis on the radiographic appearance alone is often misleading. The most malignant type of sarcoma, for instance,

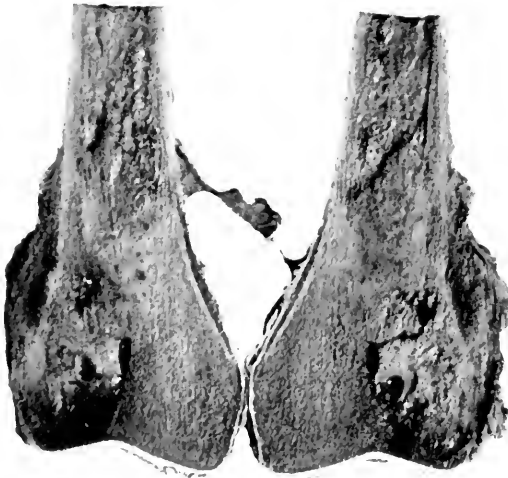

FIG. 147.—Sarcoma of lower end of femur.

The bone has been sawn longitudinally in order to show the tumour in its interior. The appearance of this tumour in the amputated limb and in the living subject are shown in Plate XXX., Figs. *c*, *e*, and *f*.

is, in the early stages at least, indistinguishable from a simple inflammatory process. Later, more decided features may be made out, but it must be insisted upon that radiographically it is often impossible to decide. The clinical history, the radiographic evidence, and in most of the early cases, at least, a fresh radiograph of the section at the time of operation should all be employed. The latter method puts the nature of the case

beyond all doubt, and decides at once the extent of the operation.

The clinical and radiographical features of cases of tumour will be dealt







PLATE XXX.—TUMOURS OF BONE.

*a.* Periosteal sarcoma of shaft of humerus. Plate XXXII fig. *a*, shows recurrence in lung two years after amputation of arm. *b.* Myeloid sarcoma of shaft of humerus confirmed by microscopic examination. There have been several fractures at the seat of growth.

*c.* Sarcoma of lower end of femur (after removal). *d.* Sarcoma of head of fibula. (Radiograph by Dr. Reid.)  
*e.* Lateral view of *c*, from living subject. *f.* Antero-posterior view of *c*.

with later, but, in passing, it may be observed that a knowledge of the macroscopic and microscopic appearances of tumours will aid the radiographer to grasp points in the progress of a case, which will often help to decide his opinion in a particular instance.

**Sarcoma** is the most important primary tumour of bone, and almost any form of this may occur. Endosteal, or central, sarcoma generally commences in the medullary cavity or cancellous tissue, and results in the so-called "expansion" of bone, which consists of an absorption of bone from within, whilst at the same time new osseous tissue is being deposited from the



FIG. 148.—Chondro-sarcoma of lower end of tibia.



FIG. 149.—Sarcoma at upper end of humerus. This is a form of periosteal sarcoma which rapidly involved the soft parts. Radiographically, the humerus showed very faint irregularity at the periphery with thickening of the bone.

under surface of the periosteum. The radiographic appearances will correspond with the pathological changes. Expansion of the bone with debris in the centre or sarcomatous new tissue, will be shown in the plate. The new bone forming from the periosteum is deposited in more or less definite layers. When considerable expansion of bone occurs, it can readily be distinguished from inflammatory change processes, or cysts of bone, by the somewhat sharp nature of the expansion. The shaft above and below the growth is normal, and suddenly expands at the site of the tumour. The growth usually commences at the end of a long bone. It seldom encroaches on the articular cartilage, so that the joint escapes, although it may be distended with fluid. Dr. Emery, of King's College Hospital, has been good enough to report on the tumour shown in Fig. 148. It consists of a cellular matrix, composed for

the most part of large, round, or oval cells, having large nuclei, sometimes multiple. There are also a few myeloplaxes. This part of the tumour is sarcomatous in type. Set in this tissue are numerous masses of cartilage, fairly well formed, but with tumour cells (like those of the matrix) instead of ordinary cartilage cells. The tumour is a chondro-sarcoma.

Spontaneous fracture is a not uncommon complication, and owing to the expansion of the bony framework, "egg-shell crackling" may be met with. Later, the growth may expand beyond the bony limits of the growth, and secondary deposits occur, the substances in which these are found depending upon the type of the primary tumour. The lungs and mediastinum are frequently the seat of secondary growths.

The periosteal type of sarcoma is not at all easy to distinguish. It may

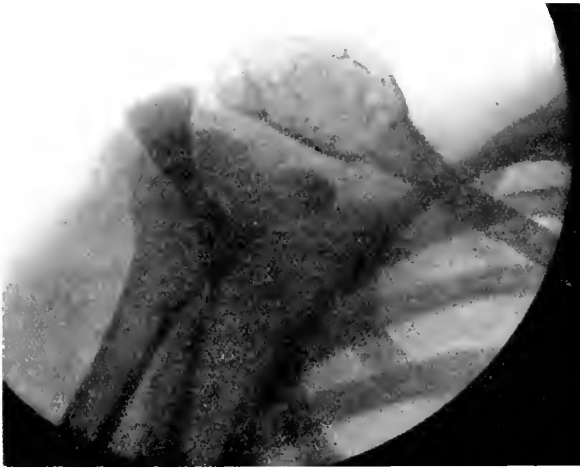

FIG. 150.—Tumour of clavicle (Radiograph by Dr. R. W. A. Salmond).

Sarcoma of acromial end of clavicle. This has the appearance of a cystic condition of the bone. It developed rapidly.

appear as a decided shadow of about the density of the soft parts, arising from the surface of the bone. It involves the soft structures, extending into them in some instances. The periosteum may show thickening, which will be revealed radiographically.

Myeloid sarcoma in its least malignant form may simulate a cyst of the bone. It is of slow growth, and occurs at the ends of long bones. Spontaneous fracture may occur in this as in cystic disease.

**Hydatid cyst** may also be met with. It is more chronic in its progress, and shows a well-defined, fairly regular outline.

**Carcinoma of Bone.**—This is usually secondary to a primary focus elsewhere—in the breast, genito-urinary tract, etc. It is generally a late secondary manifestation, the bones most frequently affected being the sternum, ribs, and spine. The disease may also invade a large joint, or the shafts of the long bones become involved. The sacrum or iliac bones may also be

invaded. The presence of these secondary deposits is shown radiographically by rounded irregular shadows of varying density, generally lighter than the normal bone. In other cases the disease takes the form of carionecrosis, when cavities filled with necrosed tissue are produced, and appear on the screen or plate as lighter areas.

**Exostoses.**—These show as projections, sometimes of normal bone tissue, and sometimes of rarefied or unusually dense bone; the situations in which they are met with are numerous, as in the ends of the long bones, bones of the feet, the pubis, etc.

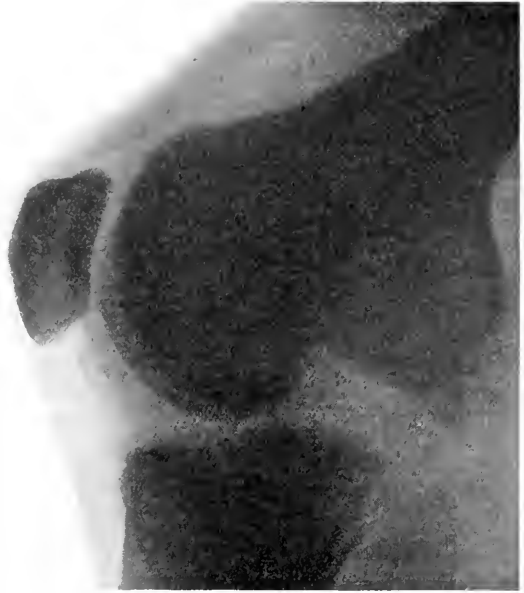

FIG. 151.—Exostosis of lower end of femur. Shows signs of inflammatory changes at end of exostosis, probably secondary to trauma.

**Chondromata.**—These may occur in any bone, but particularly in the long bones, and also in the bones of the fingers and toes.

## Differential Diagnosis of Tumours of Bone

A brief summary of the commoner forms of tumour of bone and of the points which are most useful in diagnosis is necessary. It is also well to remember that there are no positively definite signs of any particular tumour. Clinical data and radiographic records should be taken together if the examination is expected to be of value.

The appearance of a shadow of doubtful nature in one of the long bones raises most important questions of diagnosis. The benign cyst has recently been shown to be a comparatively common tumour of bone. The term benign is used in relation to the degree of malignancy and growth rather than as a pathological classification. Many of these so-called benign growths are myeloid sarcomata, which are peculiarly slow in the rate of growth. The tumours most likely to lead to difficulty in diagnosis are those which are found in the interior of the shaft of a long bone, or at its epiphyseal ends, and which have rarefied or replaced the osseous or medullary tissue, with or without expanding the bone, and which are situated within the osseous tissue of the bone. Such tumours may prove to be (1) central abscess, tuberculous or septic; (2) gumma; (3) hydatid cyst; (4) benign cyst;

(5) fibrous osteitis; (6) enchondroma; (7) endothelioma; (8) secondary carcinoma; (9) myeloma; (10) sarcoma.

The points to be considered are: (1) history; (2) physical signs; (3) evidence of disease or tumour in other parts of the body; (4) radiographic appearances, and a correct interpretation of these. The chief of these, so far as our purpose is concerned, is the radiographic appearances, though all should receive attention.

The points of importance radiographically are the site of the tumour in the bone, its density and consistence, whether subdivided by trabeculæ, its outline, whether sharply defined and surrounded by a well-defined shell

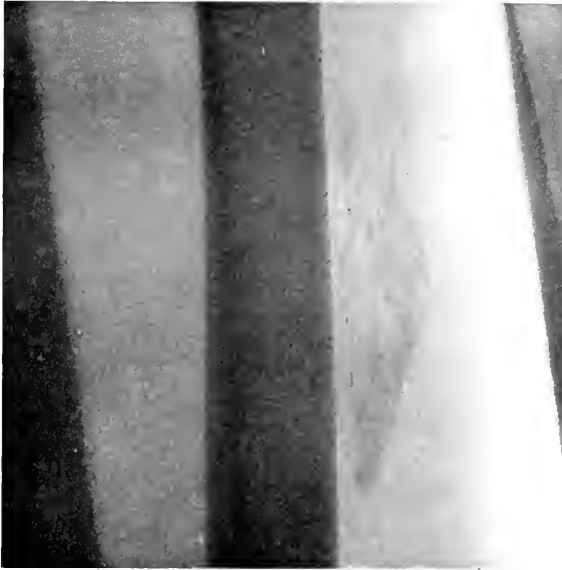

FIG. 152.—Traumatic myositis ossificans.

Note the unchanged aspect of the bone. The ossification in the muscle bundles is quite distinct from the periosteum.

of bone, whether the bone around is normal or rarefied, presence of deposits of new periosteal bone or sclerosed bone, the presence of a fracture, the evidence of erosion of the bone.

*Traumatic Myositis Ossificans.*—A condition which arises in the substance of a muscle secondary to trauma. It occurs most frequently in the arm or the thigh. The appearances are characteristic and must not be mistaken for sarcoma arising from the periosteum. Fig. 152 illustrates the typical appearances in this condition.

*Central abscess* is generally accompanied by symptoms, however slight, namely, pain and loss of power, indicating an inflammatory process, and occasionally by fluctuations in temperature. Radiographically, the cavity is not as a rule strictly central, and the surrounding dense bone is unequal in its thickness. The outline is often indefinite, the cavity is not very clear,

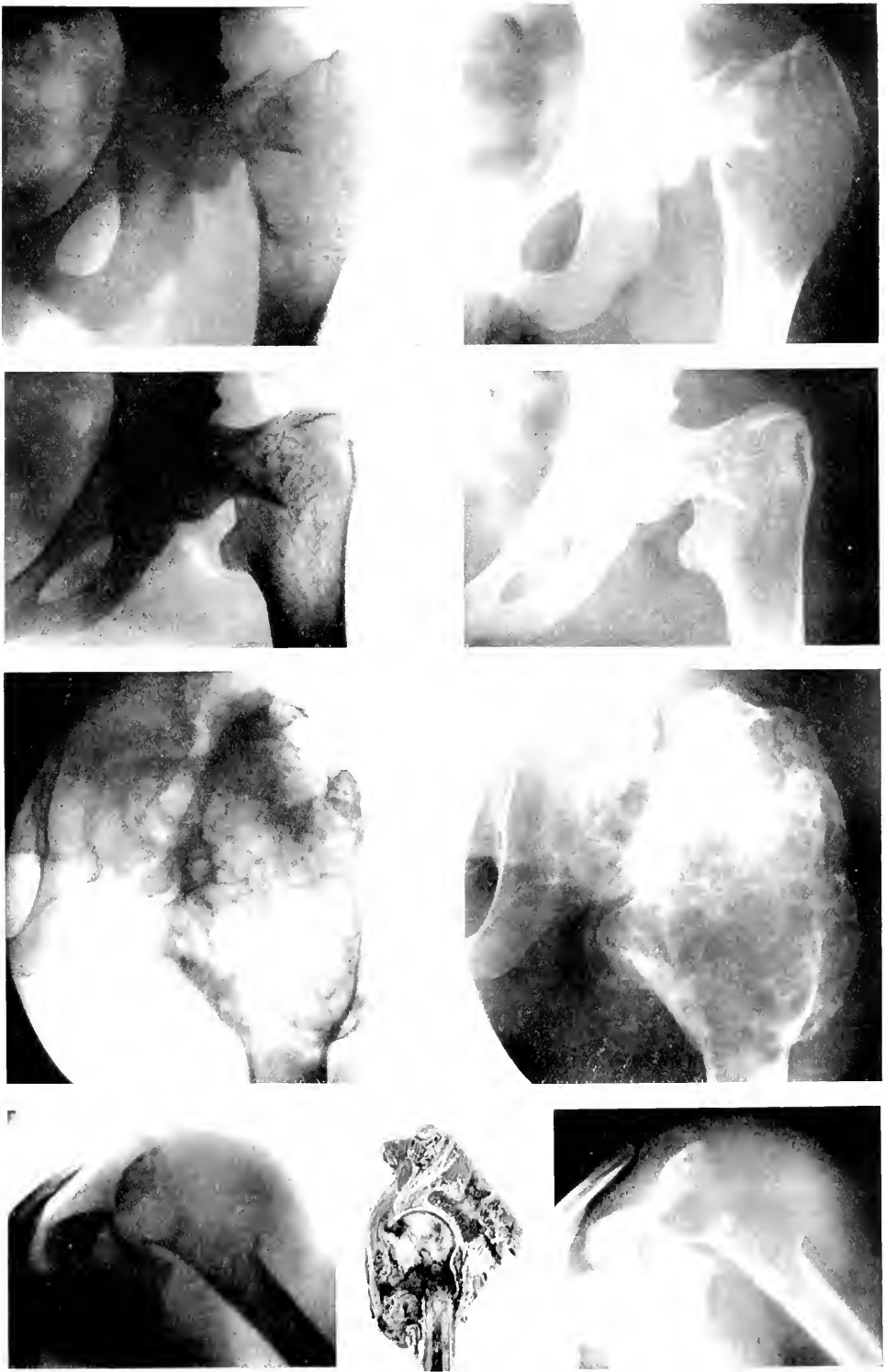

PLATE XXXI.—TUMORS OF BONE.

*a*, Secondary sarcoma affecting upper end of femur, fracture through neck. The primary lesion was a periosteal sarcoma of humerus.

*b*, Same case at an earlier stage. (Radiograph by Dr. N. S. Finzi.)

*c*, Sarcoma of upper end of femur. The diagnosis in this case is doubtful; it is most probably a myeloid sarcoma of very slow growth.

*d*, Sarcoma of upper end of humerus (inset is a photograph of the joint after removal). The humerus has been fractured probably as a result of manipulation, at or after the operation.





and there is an absence of trabeculæ. The bone around is denser, and there is generally a deposit of new bone.

*Hydatid Cyst.*—This is very rare in this country, though it should always be kept in mind when considering obscure conditions. It shows as a sharply-rounded area less dense than bone.

*Benign Cyst* is a much more common occurrence than was formerly thought. The first sign may be a so-called spontaneous fracture of the bone, this occurring as the result of violence of a mild kind. The appearances are characteristic. The cavity or cavities are situated centrally; they fill the bone uniformly, the space indicating the cyst being clear and not subdivided by trabeculæ. There is little or no sclerosis of bone, and no periosteal thickening, though this may occur as a result of fracture.

*Fibrous Osteitis.*—Probably always originates in early life. It is characterised by swelling and deformity, the latter being due to bending of the softened bone. The disease may be localised to one bone, the upper end of the femur being the most frequent site, when the bone is expanded. Skiagrams show expansion of nearly the whole shaft. There are great variations in density, and an appearance of subdivisions by trabeculæ. These appearances lead in the diagnosis to confusion between this condition and myeloma.

*Secondary Carcinoma.*—Radiographically, there may be seen a clear area in the middle of the shaft of a long bone or a rib, giving the appearance of a rarefied patch in the bone, covered by a thin shell of compact bone, and fading gradually up and down the shaft into normal bone.

*Myeloma.*—They are most likely to be confused with benign cyst or with fibrous osteitis. They are generally found at the ends of the bones. Radiographically, the distinguishing features are the expansion of the bone and the subdivision by trabeculæ.

*Sarcomata of Bone.*—These are periosteal and endosteal. The former are often difficult to distinguish from inflammatory thickening or myositis ossificans traumatica.

*Medullary Sarcoma* is probably the rarest of the endosteal tumours of bone. The bone is expanded with great rapidity, and the bony shell is often eroded. Erosion seen in a skiagram should always excite suspicion of the true nature of the disease. The appearance in a skiagram of a clear space in the shaft of a bone, expanding the bone unequally, and showing erosion of the bone substance, should lead to the suspicion of sarcoma.

# THE X-RAY EXAMINATION OF THE THORAX AND ITS CONTENTS

The complete routine examination of the thorax includes an investigation of the bony walls, the heart and aorta, the lungs, the mediastinum, and the œsophagus. The bony walls have been dealt with in the chapter on injuries of bones, and the œsophagus in that on the alimentary system. For our present purposes, therefore, the routine examination of the chest consists of a scrutiny of the heart, the lungs, and the mediastinum by the methods of Radioscopy and Radiography.

## Radioscopy

Radioscopy, or the examination of a patient with the fluorescent screen, is a method of great value, as a diagnosis can often be made from it alone, to be subsequently confirmed by radiographic exposures. To obtain reliable results it is essential that the technique should be complete.

**Technique of Examination.**—Several methods are employed :

1. *The Recumbent Position.*—The patient may be placed on the X-ray couch, the tube working from below and the operator manipulating the screen. The position of the tube and of the diaphragm aperture are adjusted to suit the requirements of the case. It is essential to have a good X-ray tube of the proper degree of hardness, and an evenly-spread fluorescent screen.

2. *The Upright Position,* with the patient standing in front of the X-ray tube, is undoubtedly the best. For this method, a well-protected screening stand, all the parts of which work with ease and smoothness, is necessary. The particular form of stand varies with the desires of the operator, but in order that good results may be obtained a good stand is essential. A convenient form is illustrated opposite. A few minutes' consideration of the mechanism will familiarise the operator with its movements, and it need not therefore be described. A rectangular diaphragm is better than one of the iris shape, as with the rectangular form it is possible to examine in detail the roots of the lungs in their entirety.

The room should be completely darkened, not even a glimmer of light being permissible when the tube is working. An open fireplace for heating purposes is not advisable, but if such is used, then efficient steps must be taken to exclude light from it during the examination. It is also necessary to enclose completely the X-ray tube and valve tubes in a box or in black

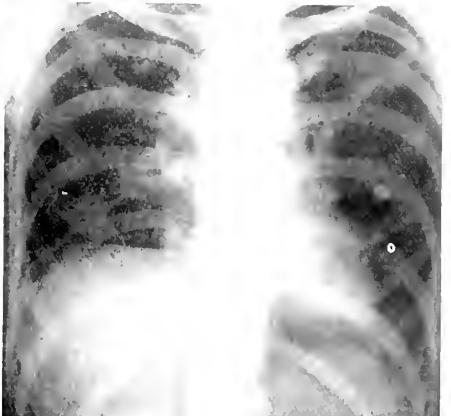
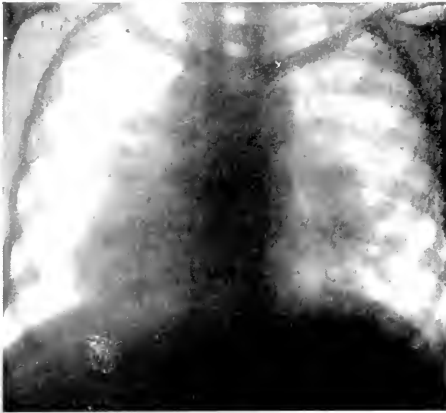

PLATE XXXII. - MALIGNANT DISEASES OF THE CHEST.

*a.* Secondary deposits of sarcoma in mediastinum and lungs.

*b.* Lympho sarcoma of mediastinum, extending outwards from root of lung towards the periphery.

*c.* Secondary deposits of cancer involving mediastinal glands, lung substance, and pleura; the diaphragmatic surfaces of the right lung and the liver are also involved.



cloth, and even the front of the X-ray box must be covered with an opaque cloth, if reliable observations are to be made.

These precautions taken, the operator should allow a few minutes to elapse in the darkened room before the current is allowed to pass through the tube, in order that the retina may become sensitive to the fluorescent appearance of the screen when the tube is working.

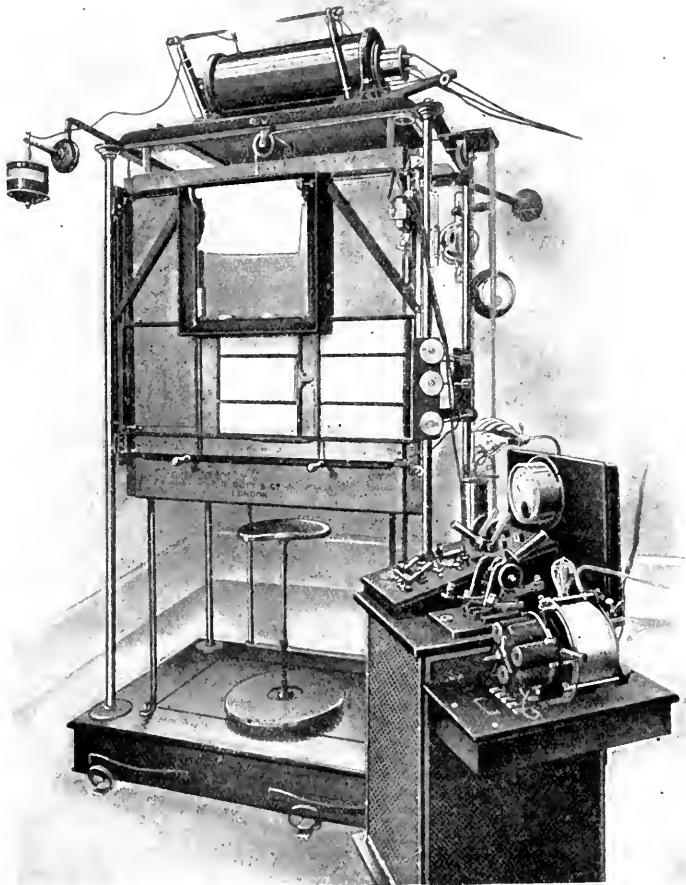

FIG. 153.—Upright screening stand, with automatic stereoscopic movements of tube- and plate-holder controlled from the switch-board. Suitable for taking radiographs of the thorax. (Butt and Co.)

**The Routine Examination.**—This should always be carried out in a definite order. The tube should be first centred over the heart, with the diaphragm opened to its widest limit. This enables a view of the whole of the thorax to be obtained. Then the tube should be carried well down, and the movements of the diaphragm examined for limitations on either side, and the presence of dullness at either base looked for.

Next the heart and aorta are carefully scrutinised for abnormalities of size, shape, or position, or for the presence of pulsation in abnormal situations.

The tube should then be moved over to the right side of the chest, and the diaphragm of the apparatus closed laterally until a long slit aperture is obtained. This is carefully adjusted over the hilus of the lung for the detection of enlarged or cancerous glands. The appearance of the shadows at the root of the lung should be noted. Repeat the observation on the left side.

Great care should be exercised in the examination of the apices of the lungs, both as regards the quantity of current passing through the tube



FIG. 154. —Thorax of an adult, showing practically a normal condition except at the root of right lung where there is a slight increase of shadow. (Exposure  $\frac{1}{4}$  sec.)

and the observation of the apices themselves. After one apex has been examined a mental note should be made of the degree of the illumination present, and the tube then passed over to the other side. Differences between the two apices should be carefully noted.

The current passing through the tube should be regulated by the operator, and this is best done by an adjustable rheostat close to his hand. With a soft tube and a small primary current, very fine detail in the lung substance can be made out. This is most important, for it is often by the

examination of this detail that a diagnosis of early tubercular disease may have to be determined.

Diagrams may be made on the read glass in front of the fluorescent screen of any particularly striking departure from the normal, alterations in the diaphragm can be sketched in, and the amplitude of movement on inspiration and expiration noted. A permanent record of the amplitude of respiratory movements of the diaphragm can be obtained by getting the patient to inhale fully and hold the breath. An exposure is made. Then the patient exhales forcibly, and holds the breath while another exposure is made. The two



PLATE XXXIII. CHEST SHOWING PLEURAL EFFUSION AND ITS ABSORPTION.

Three plates from the same patient at intervals of several months.

*a*, Plate on anterior aspect of thorax, shows practically a normal condition. Note level of diaphragm on both sides.

*b*, Effusion at left base. The level of the diaphragm on left side is much higher than in above plate.

*c*, The effusion has been absorbed but the level of the diaphragm remains higher, indicating the presence of adhesions fixing the dome of the diaphragm on the left side.





shadows on one plate show the degree of diaphragmatic excursion. All observations of this kind should be immediately transferred to paper on completion of the examination, and entered in the notes of the case.

These observations are of the greatest value in all cases ; but if they are to be useful a note must be made at once, otherwise the personal element will enter largely into the case. Even under the most favourable conditions this factor must be considered, since it is the great objection to all screen examinations. In no other region of the body are we so absolutely dependent upon screen examination of a patient. The trained eye of the observer may detect changes in movement in lungs or heart which it is impossible to record upon a plate. But radiographs which are taken instantaneously are of great value as confirmatory evidence of changes in the organs, and should always be taken to complete the examination. The importance of having a thoroughly reliable fluorescent screen must be borne in mind. It is also essential that the screen be smooth on the surface, and kept scrupulously clean. The lead glass protection should also be kept well polished, for even a trace of dirt or pencil mark on its surface may lead to trouble, the importance of this point being readily understood where fine detail is being dealt with.

It is also of importance to have the patient perfectly still, especially when radiography is employed, since the slightest movement during the exposure may ruin the value of a plate.

The screening stand should be connected to earth by a wire, in order to avoid giving the patient a shock from the electrical discharges which are given off from the tube and metal fittings when the former gets hard.

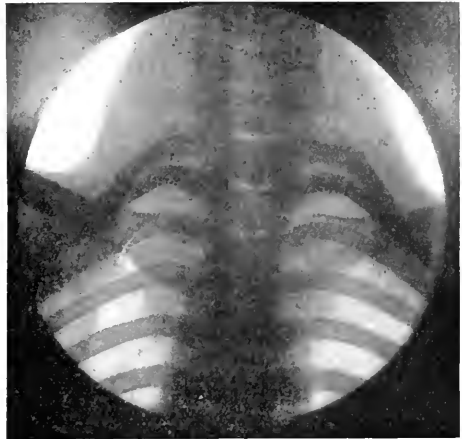

FIG. 155.—Normal lower cervical and upper dorsal vertebrae, showing the position for demonstration of cervical ribs. The apical part of both lungs is also well shown.

## Radiography

In radiography of the lungs for diagnostic purposes it is necessary to use a soft tube in order to obtain the best results. It is detail in lungs and not in bone that we look for. A soft tube of about 3-inch spark-gap will allow a large quantity of current to pass through it, and will give very good detail in the soft parts.

Time exposures of any length are of no great value for diagnosis ; if we are to get plates which will to any extent reproduce what we have seen on the screen, the exposure must be exceedingly short ; in fact, the shortest obtainable is the best. With a powerful modern installation the exposure

may be cut down to  $\frac{1}{100}$  of a second. The resulting picture is of great value, because everything is absolutely sharp, the heart being represented in outline by the sharpest possible line. The diaphragm is also sharp, and may be caught in a stage of contraction. This is well shown in a print from a case of early phthisis (see Plate XXXV., Fig. b).

The hilus of the lung is also well shown. The branching of the bronchi and larger vessels can be followed to the periphery, and if the tube has been in the proper condition a faint mottling all over the surface represents the lung substance.

From a comparison of such pictures obtained from normal subjects it is quite easy to detect changes which occur in diseased conditions, especially in the very early stages of tuberculosis of the lung. Even with the most up-to-date apparatus it is still necessary to use an intensifying screen, if the exposure is to be of the shortest possible duration. With a screen of this kind quite good pictures may be obtained with much less powerful installations, but their diagnostic value in very early cases is not nearly so great.

The important point in these very rapid exposures is that they reproduce one phase of what one sees when a screen examination of the chest is made, with all the movements of the parts eliminated, so that when compared with the result of a prolonged screening they afford valuable confirmatory aid to the making of a diagnosis. Plates taken with time exposures can only be of value when a gross lesion is present. Another point in favour of these rapid exposures is that involuntary movements on the part of the patient are not so likely to spoil the result.

In radiography of the thorax and bones of young children there is always difficulty on account of movements during the exposures. The child has often to be held on the plate. The rapid exposure is of great value in such cases, for even when the child is moving a sharp radiograph may be obtained with an exposure of  $\frac{1}{100}$  of a second. The exposure is so short that movement is practically eliminated and good detail is obtained. Short exposures are, therefore, particularly useful in radiography of the thorax.

**Attention to Detail.**—In this branch of the work, and indeed in all branches, only the most careful attention to detail in all directions will aid us in the production of reliable pictures, and a good routine is essential. Mechanical contrivances which facilitate movements of apparatus, and enable us to reproduce at subsequent examinations the same relative positions of tube, patient, and plate, will be found of the greatest service. The fluorescent screen should be adaptable for the ready insertion of the plate when an exposure has to be made. Since the work is conducted in the dark, all metal points should be insulated or the whole apparatus earthed, and all the controlling factors must be at hand. Nothing is more trying than work of this exacting nature with the factors out of order. Consequently, great care should be exercised in the selection of all apparatus, with all the features of which the operator must be perfectly familiar.

It is important for the operator to have control of the X-ray tube when

screening. A convenient form of regulator is the Bauer air-valve, a most ingenious method of admitting a small quantity of air into the bulb, the pressure of a small hand-pump forcing it through a mercury valve. By this contrivance the operator can regulate the hardness to the requisite degree without stopping the examination.

Experience in the use of the Bauer air-valve for regulation of the vacuum of the X-ray tube leads to the conclusion that unless great care is exercised in its manipulation the tube soon becomes hard, and requires to be constantly regulated when in action. Other forms of regulator may therefore be useful, such as the Osmosis regulator, where a small gas flame can be used to soften the tube. The control pump for the gas supply may be placed at a point convenient for the operator. When neither of these regulators is available the operator must regulate the tube by the usual method of sparking until it is at the proper degree of hardness for the particular case he is examining. The vacuum can then be kept more or less constant by regulating the quantity of current passing through the tube by means of the regulating rheostat. It is a good practice to commence the screen examination with the tube slightly on the hard side. A prolonged screening will reduce the vacuum, and when a radiograph requires to be taken, it will be found that the tube has attained the requisite degree of hardness. It is an advantage to keep one tube for radiography and another for screening.

The Bauer air-valve is figured in the chapter on apparatus (see page 46). The Bauer regulator is also attached to the valve tubes when these are used. The two hand-pumps controlling the valve and X-ray tubes can be placed within the reach of the operator. The control table may also be within easy reach. A foot switch to control the lighting of the room is also useful. Then the operator has all the factors under his personal control during the screen examination of the patient.

A point to be insisted on is that in every case examined a consideration of all the factors in the case is essential, and a diagnosis should never be made on the X-ray appearances alone. The physical signs are most important, and some guide should be given by the physician to the radiographer if the best value is to be obtained. The findings by X-rays are frequently only a confirmation of an opinion already formed. It is true that in some cases the extent of the disease may be greater than the physical signs indicated, or an area of disease may be shown to exist in unsuspected regions, but on the other hand radiography may fail to show a definite lesion when all the signs and symptoms strongly indicate its presence. The type of case which most frequently calls for a radiographic investigation is that of incipient phthisis. Tuberculosis of the lung in all its varieties and stages will fall to be examined, but it is the doubtful case which proves the value of radiography. Here the rapid exposures will help greatly in settling the diagnosis. The expert clinician can foretell changes which radiography may fail to demonstrate, but the fact of its failure does not negative their presence.

The expert radiographer may be more accurate than the inexpert

clinician. The combination of the expert radiographer and the expert clinician cannot fail to enhance the value of the observations of each. Cases will occur when both may be wrong. Repeated examinations at intervals by both may show the changes at a later date, and the record furnished by radiography of the progressive stages of a disease must lead to the accumulation of knowledge valuable for both.

The value of repeated examinations of the thorax in some diseases is shown by the results obtained at the Cancer Hospital, London. All cases of cancer of the breast and other parts are systematically examined at intervals, valuable evidence being thus obtained of the condition of the pleura, the roots of the lungs, and the mediastinum. The progressive changes caused by secondary deposits in the pleura, the lungs, and the mediastinum are frequently shown.

## Diseases of the Thorax

A brief consideration of the pathology of conditions affecting the thorax and its contents is necessary before discussing the radiographic appearances and the differential diagnosis. This review must necessarily be brief, for it is not within the scope of this work to do more than mention the various forms, with a short reference to the macroscopic appearances of such diseases, their common situations, and some points of difference in their origin and spread which have a bearing on the radiographic interpretation. The conditions that will be referred to are :

- (1) Diseases of the lungs.
- (2) Diseases of the pleura.
- (3) Diseases of the heart.
- (4) Diseases of the mediastinum.
- (5) Malignant disease of the thorax, including tumours of the heart and pericardium, the lungs and pleura, the mediastinum, the œsophagus, the spine, and the chest walls.
- (6) Foreign bodies in the thorax.

**Diseases of the Lungs.**—As these are classified and described in textbooks on pathology and medicine, it will be sufficient to recall briefly the chief points which will be likely to aid the radiographer. Many of them are referred to in the section dealing with the differential diagnosis.

*Circulatory Disturbances in the Lungs.*—(1) *Congestion.*—Two forms of congestion are recognised, the mechanical and the hypostatic, the latter being the one most likely to show signs on radiographic examination. All grades of change may be seen passing into consolidation.

(2) *Broncho-Pneumonia.*—The lung is fuller and firmer than usual, on section, and the general surface has a dark-reddish colour. Projecting above the level of the section are lighter-red or greyish-red areas, representing the patches of broncho-pneumonia. These may either be isolated and separated from each other by uninflamed tissue, or they may be in groups, or the greater part of a lobe may be involved. The disease may pass on to the stage to

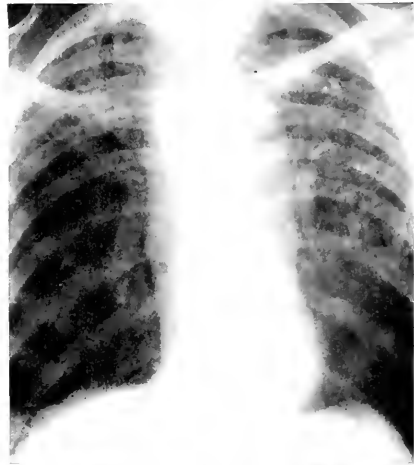

PLATE XXXIV.—CHESTS SHOWING PULMONARY TUBERCULOSIS.

*a*, Right apex showing advanced consolidation; left apex involved but disease not so advanced; roots of lung both involved but more so on right.

*b*, Left side of chest extensively involved; both apices are involved; heart small and "vertical." These two cases are both affected by active tuberculosis.

*c*, Healed tuberculosis of long standing; both apices show signs of involvement; roots of lungs show evidence of calcified glands. Patient had no active symptoms.



which the term splenisation has been given, when it may be accompanied by a condition of collapse of parts of the lung.

(3) *Chronic Interstitial Pneumonia (Cirrhosis of the Lung, Fibroid Phthisis)*.—There are two chief forms, the massive or lobar and the insular or broncho-pneumonic form. In the massive type the disease is unilateral, the chest of the affected side is sunken and deformed, and the shoulder much depressed. The heart is drawn over to the affected side, the unaffected lung being emphysematous, and covering the greater portion of the mediastinum. There may be dense adhesions, and the pleural membranes may be greatly thickened. In the broncho-pneumonic form the areas are smaller, often central in position, and are found most frequently in the lower lobes.

(4) *Lobar Pneumonia* is classified by physicians amongst the specific infectious diseases, but for radiographic purposes it may be described together with the more chronic forms of pneumonia. Three stages of the process of inflammation are recognised: (a) engorgement, (b) red hepatisation, (c) grey hepatisation. In red hepatisation the lung tissue is solid, firm, and airless, it may be friable, and the surface has a granular appearance. Grey hepatisation is a further stage in the inflammatory process, and it may, though rarely, go on to abscess formation. The disease is usually confined to a single lobe of the lung, but the adjoining lobes may, however, be congested, and in some instances the whole lung or both lungs may become involved.

(5) *Tuberculosis of the Lungs*.—All forms may be met with.

**Diseases of the Pleura.**—These require to be briefly considered, because the occurrence of one or other of them may give rise to a difficulty in diagnosis; and also in the course of a malignant tumour of the lung, pleurisy and effusion are common sequelæ. The simple form of pleurisy is easily recognised. Hæmorrhagic pleurisy may occur when carcinoma of the lung is present. Diaphragmatic pleurisy may be limited partly or chiefly to the diaphragmatic surface. It is often dry, but may be accompanied by effusion, either serofibrinous or purulent, which is circumscribed to the diaphragmatic surface. Serous or purulent effusions of any size confined to the diaphragmatic surface are very rare. Encysted pleurisy may lead to a loculation of the resulting empyema, which will give a shadow that may be quite indistinguishable from that caused by a new growth or a primary abscess of the lung. Interlobar pleurisy is another condition which must be borne in mind when considering a doubtful negative.

**Diseases of the Heart.**—Tumours of the heart are rare, but there are conditions which may simulate tumour, and which must, therefore, be mentioned. These are tuberculosis and syphilis.

*Tuberculosis of the Heart.*—This occurs as: (a) scattered miliary tuberculosis; (b) large caseous tuberculosis, extremely rare; (c) sclerotic tuberculous myocarditis. The disease generally proceeds from a mediastinal gland, this fact being important from a radiographic point of view.

*Syphilis.*—Gummata are the only manifestations of this disease likely to attract the attention of the radiographer in the cardiac region.

**Diseases of the Mediastinum.**—In simple lymphadenitis and suppurative lymphadenitis, the glands are large and infiltrated, but are not usually dense enough to cast shadows sufficient to complicate a diagnosis. Suppurative lymphadenitis may, however, lead to abscess formation, and then a large shadow may be found due to the presence of pus. Both these conditions may simulate tumour. Abscess of the mediastinum is not at all uncommon, and may be of considerable size. It is secondary to an infective process, *e.g.* erysipelas, eruptive fevers, and tuberculosis. Indurative mediastino-pericarditis is a condition in which the pericardium may be greatly thickened by a great increase of the fibrous tissue. This may give rise to changes in the mediastinal shadows.

**Malignant Diseases of the Thorax.**—The tumours most commonly met with will be considered first, then the rarer conditions, and finally tumours involving the bony structures composing the walls of the thoracic cavity, namely, the vertebræ, ribs, sternum, and costal cartilages, will be briefly considered.

*Tumours of the Heart* are very rare. An enlarged, hypertrophied, or dilated heart may, however, complicate a diagnosis when a malignant process is situated in the near vicinity. Primary cancer and sarcoma are extremely rare. Secondary tumours—sarcomata and carcinomata—may occur, either directly or by extension from the pleura and pericardium. Calcareous patches occurring in a greatly dilated aorta may, when viewed laterally, simulate the appearance of secondary growths in the mediastinal glands. When these occur the outline of the dilated aorta is seen as a rule, particularly if there is an associated condition of arteriosclerosis, and these shadows should, therefore, be capable of differentiation from the more serious condition of growth. A hydropericardium may lead to difficulty when the pleura also contains fluid, both of these structures becoming involved when there are secondary deposits of malignant disease in the pleura.

*Tumours of the Lungs and Pleura.*—Primary tumours are rare, and primary cancer or sarcoma as a rule involves only one lung. Secondary growths are not uncommon, and may be of various forms, generally following tumours of the digestive tract, the genito-urinary organs, or the bones, and, most frequently of all, cancer of the breast. The types most usually met with are in order of frequency: (1) scirrhus cancer; (2) epithelioma, which may be primary in the bronchial tract; (3) sarcoma; (4) fibroma; (5) enchondroma; (6) osteoma (very rare). The lungs may also be involved in Hodgkin's disease. The primary growth generally forms a large mass, which may occupy the greater part of the lung. It may by extension outwards involve the parietal and visceral pleura. The tumour mass may necrose, and a cavity result. The diffuse cancerous growth may resemble a tuberculous pneumonia. The metastatic growths are nearly always disseminated; they may vary from a miliary type to quite a large growth, and all variations in size may be met with in the same patient. The symptoms may be slight or marked according to the accessory lesions which accompany the new growth, such as pleurisy; this may be dry or accompanied by effusion.





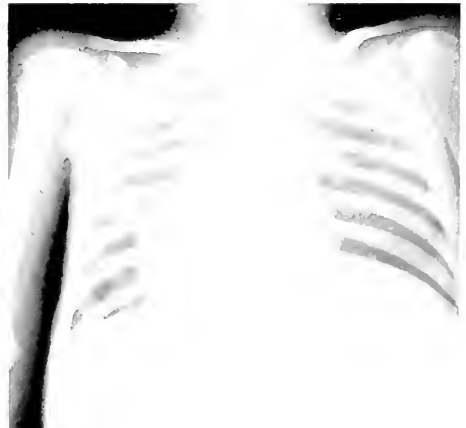
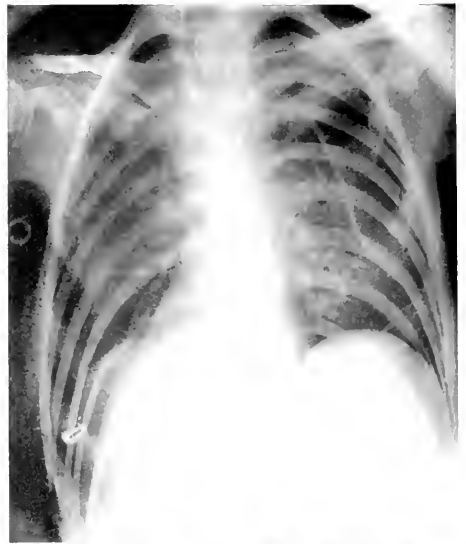

PLATE XXXV. CHESTS SHOWING PULMONARY TUBERCULOSIS.

- a.* Post-mortem subject. Note fine shading in lung substance. Tuberculous broncho-pneumonia.  
*b.* Early tuberculous of lungs, peribronchial thickening, irregularity of diaphragmatic shadow on right side, with sharpness of all detail. Exposure 1/2 second, intensifying screen used.  
*c.* Acute general tuberculous of both lungs (miliary tubercles).

*Tumours of the Mediastinum.*—Cancer is the most common form of tumour in the mediastinum. There are three chief points of origin: the thymus, the lymph glands, and the pleura and lungs. Primary sarcoma is more frequent than primary cancer. Lympho-sarcoma and lymphadenoma frequently give rise to large tumours.

*Tumours of the Œsophagus.*—The most common tumour is epithelioma, and it occurs more frequently in males than females. The middle or the lower third of the œsophagus is the most usual situation in which the growth is found. It is at first confined to the mucous membrane, but soon breaks through and extends into the mediastinal tissue, stricture occurring in the lumen of the tube. Later on, when ulceration of the mucous surface occurs, the stricture may be less marked than in the earlier stages. In the course of the disease the œsophagus above the growth becomes dilated, and a degree of hypertrophy follows. The ulcer may perforate the trachea, the lung, the pleura, the mediastinum, the aorta or one of its branches, or it may erode the vertebral column.

*Tumours of the Spine.*—Tumours, simple or malignant, may arise in connection with the spine, the ribs, the intercostal spaces, and the costal cartilages. These may by extension involve the adjacent organs, and when the lungs and pleura become implicated shadows are obtained which are indistinguishable from new growths of primary origin in those structures. Conditions involving the spine which may lead to error are: (1) Tubercular caries. In the early stages an inflammatory process leads to thickening and abscess formation which simulate new growths of the spine: rise of temperature and other signs of tuberculosis should be looked for. (2) Abscess following caries is a frequent cause of difficulty in diagnosis. (3) Sarcoma arising from the costal cartilages and sternum may lead to the formation of a definite cystic condition indistinguishable from hydatid cyst. A hæmorrhagic condition in the tumour may simulate the appearance presented by a cyst.

*Tumours of the Chest Walls.*—Sarcomata in these positions are occasionally met with. They may be solid, or, when growing rapidly, may become cystic or hæmorrhagic, and when examined show shadows which may be mistaken for new growths of the lungs or pleura.

**Foreign Bodies in the Thorax.**—Various forms of these may be met with, particularly in children. A foreign body should first be located by means of the screen, and stereoscopic radiographs taken for exact localisation. If an operation is contemplated, then the examination should be repeated just prior to the time of operation, in order to obviate the risk of change of position of the foreign body. The thorax and cervical region require to be carefully examined when a foreign body is suspected to be present. Lateral pictures are useful, particularly when the foreign body is located in the upper air passages.

## Differential Diagnosis in Diseases of the Lungs

The differential diagnosis of these conditions is always difficult, particularly from a purely radiographic point of view. The X-ray findings are usually shadows of abnormal growths, invading shadows representing the normal structures, and it is often on slight variations of these normal shadows that a diagnosis may be made. A fine departure from the normal may be the earliest manifestation of a commencing new growth, and its presence may be detected before physical signs or symptoms call attention to the presence of serious mischief. On the other hand, however, it is occasionally found that persistent symptoms, such as pain, slight cough, dyspnoea, may be present for months before the presence of a neoplasm can be detected by radiographic examination. This is particularly evident in the *recurrent forms of carcinoma* after operation, where pain at a fixed point may for a very long time be the only sign of recurrence. Later this may be followed by the demonstration of a gradually increasing shadow, or a slowly accumulating pleural effusion, indicating that the pleura has become involved. The occurrence of these infiltrating secondary carcinomata of the pleura is interesting. The extension is usually by direct continuity from the chest wall, the growth developing through the intercostal spaces, slowly involving the pleura on the parietal aspect, spreading along the internal aspect of the ribs, and forming flat plaques which do not penetrate to any degree. These plaques are shown as fine shadows along the lines of the ribs. Fluid is slowly exuded into the pleural sac, and, later, the visceral layer of the pleura becomes involved, at a still later stage the lung itself becoming invaded by masses of slowly increasing size. In contradistinction to this it must be borne in mind that the secondary invasion of carcinoma may begin in the mediastinal glands or those at the roots of the lungs. It then spreads along the bronchial glands, and at a late stage of the disease we may find the pleura studded with plaques on its parietal and visceral aspects, with an accumulation of fluid in the pleural sac, the mediastinal glands enlarged, and the whole of the lung riddled with growths of various sizes. Radiographically, all these stages of secondary carcinoma may be shown in the same case if examinations are made during the progress of the disease. The various progressive stages of this form of malignant disease are well worthy of careful study, for all these forms are sure to require investigation. In the earlier stages it is extremely difficult to establish a diagnosis on radiographic evidence alone; all the facts of the case require careful consideration, and other methods are helpful, particularly in some cases where tuberculosis may be the alternative diagnosis, or where it may be an accompanying condition. The combination of the two diseases is rare, but they may occur in the same patient. Hæmoptysis may be a determining factor in the diagnosis, especially if it occur to any extent. Hæmorrhage to a marked extent from a secondary carcinoma is comparatively rare, whereas in tuberculosis it is often the first symptom to call attention to the disease.

**Simple Tumours of the Lung.**—These are very rare. Tumours of



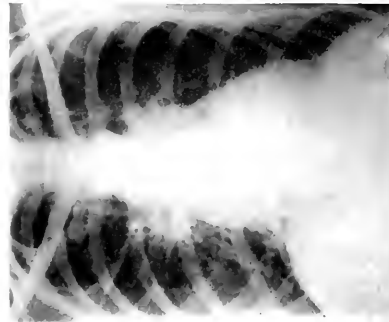
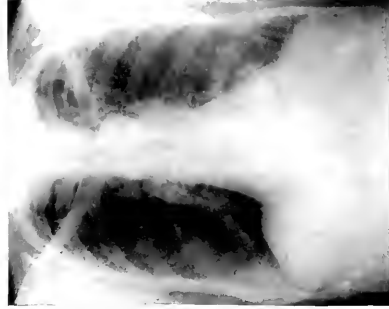
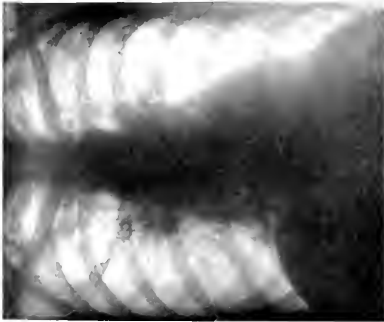
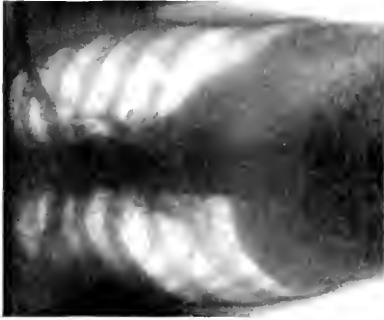
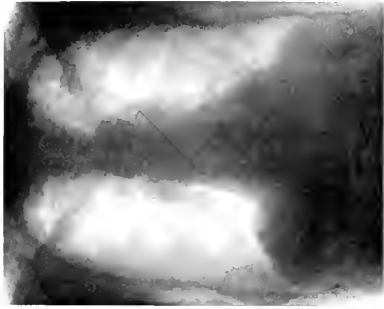

*d*

*c*

*b*

*a*

PLATE XXXVI.—CHESTS SHOWING SECONDARY CARCINOMA.

Radiographs from patients who had been operated on for cancer of the breast; all four patients had recurrent growth in the thorax; these were observed at various stages of the disease. *a*, Secondary deposit of cancer at root of right lung, spreading out from the mediastinum. *b*, Secondary deposit at root of right lung. *c*, Widening of mediastinal shadow in upper part, occurring in a patient who had the breast removed for cancer. *d*, Enlarged glands in mediastinum; patient has been slightly rotated to one side to show the glands.

the chest wall are fairly common, and may give rise to shadows which have to be differentiated from tumours of the pleura and lungs. Such tumours may be enchondromata of the costal cartilages and bones. Osseous tumours will give dense shadows, and should present no great difficulty in diagnosis.

**Primary Malignant Growths of the Lung.**—These are rare, but they do occur, and when a shadow is seen in the thorax, in a case which gives no evidence of a primary lesion elsewhere, the assumption is that it may be a primary malignant growth. Before the diagnosis is made, however, every care should be taken to investigate for a primary lesion, and the whole thorax should be carefully examined, particular attention being paid to the larynx, trachea, and œsophagus. Primary growth in the œsophagus is frequently not examined until late in its course, or until the presence of secondary deposits in the mediastinum calls attention to it. A large endothelioma may develop in the mediastinum, and invade the lung to a considerable extent before giving rise to any symptoms. Tumours of this type are of singularly slow growth, and tend to become encapsuled. The shadow given by these tumours will be well defined, and may simulate an aneurism.

**Hodgkin's Disease.**—This produces well-defined shadows in the mediastinum, and when the bronchial glands are involved these give rise to shadows which may simulate malignant growth. The shadows from a simple enlargement to a most pronounced type of sarcoma are finely graded, and any of these may present appearances indistinguishable from a well-marked malignant invasion. Time and clinical observations will help to clear up the diagnosis.

**Lympho-sarcomata.**—Malignant growths arising in connection with and having the structure of lymphatic tissue are not infrequently found in the mediastinum, invading the root of the lung. They tend to produce metastases, and may be very malignant; when well advanced they lead to rapid emaciation.

**Sarcoma of the Lung.**—This generally arises in the glands of the mediastinum, and spreading into the lung substance by direct extension, the tumour tends to become solid, and may eventually compress the lung towards the periphery. Sometimes there is a rapid spread of metastases all over both lungs. This type of tumour is frequently secondary to a lesion elsewhere. From a radiographic point of view it is often impossible to distinguish between sarcoma and endothelioma and secondary carcinoma. The history of an operation for removal of carcinoma or sarcoma of another part of the body will often settle the diagnosis. A rapidly-growing sarcoma may be disseminated all over the lung and pleura, but in the early stages the nodules will be small, and may simulate a miliary tuberculosis.

The clinical history is generally shorter in acute phthisis than in sarcoma. In secondary carcinoma the nodules are generally larger, tend to become more irregular, and may in early stages be more located to the periphery or central portions of the lung, while the presence of pleurisy or a chronic pleural effusion should help in the establishment of a diagnosis. An acute lobar pneumonia will give a well-defined shadow, generally confined to one

lobe or a part of a lobe of the lung. A few days will suffice to clear up the diagnosis, but when the pneumonic process is slow to resolve, and the lung tends to fibrosis, then a condition arises which may lead to serious errors in prognosis if full consideration is not given to all the facts of the case. Other forms of pneumonia may lead to difficulty in diagnosis, and it must be remembered that a patient suffering from primary or recurrent cancer is in a debilitated state of health, and in consequence rather prone to develop broncho-pneumonia. This may be a terminal stage of the disease, even when recurrence has located itself in the lung; the apparent extent of the mischief may be greatly exaggerated by a concurrent attack of broncho-pneumonia. When radiographs of such a condition are taken, a grave error in prognosis may be made if a large shadow in the lung substance is mistaken for a malignant deposit; further, the subsequent resolution of a pneumonic process may give the impression of an improvement in the condition of the patient, and a subsequent shrinkage of the shadow may lead to the erroneous conclusion that the tumour itself is disappearing. Similarly a pleural effusion, with thickening of both layers of the pleura, may give the impression of an actual new growth in the lung. Tapping of the pleural sac and withdrawal of the fluid, with a resolution of the inflammatory process, may be another source of error in diagnosis and prognosis. Hæmorrhage into the lung substance may also simulate a growth of considerable size.

**Infarction of the Lung (Pulmonary Apoplexy).**—This condition comes on suddenly, and may be accompanied by pain and signs of pulmonary embarrassment. The examination of a patient after the symptoms have subsided may show a fairly well-defined shadow in the lung substance, which gives rise to grave suspicions when the patient is already the subject of a cancerous invasion.

**Tuberculosis.**—As already stated, tuberculosis of the lung may be met with in all its stages, the later stages being readily recognised by the gross departure from the normal. In very early or incipient cases of phthisis it is more difficult to make positive statements, but the combined findings of the clinician and radiographer are most helpful.

The various forms of tuberculosis met with in the pulmonary system require to be dealt with in the differential diagnosis. Cases with enlarged bronchial glands will cause some difficulty. The peribronchial forms of phthisis give rise to marked increase of the hilus shadows, which are extremely difficult and often impossible to differentiate from new growth. The chief point of distinction between the two lies in the fact that in the peribronchial form of phthisis the increase of shading is more evenly distributed at both roots, and may extend up to the apex or down to the base of the lung, forming "tree root" shadows, with nodular enlargements of small size, the latter indicating the presence of calcified or fibrosed bronchial glands. When a recurrence of cancer occurs at the roots of the lungs it tends to be more definitely localised to one spot, and spreads outwards into the lung substance, while the remaining portion of the bronchial tree on that side may show no marked increase. The bronchial ramification on the other side is generally





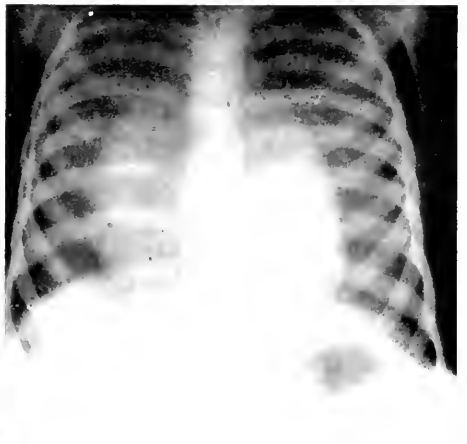
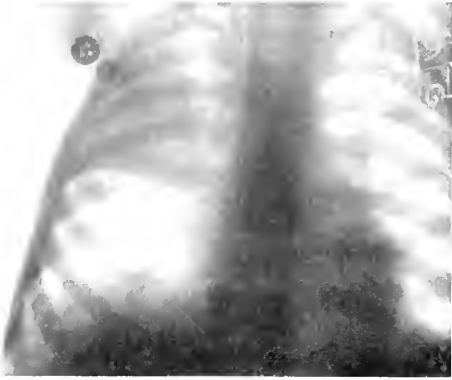

PLATE XXXVII.—CHESTS SHOWING CHANGES IN HEART AND LUNGS.

- a.* Lobar pneumonia, localised to right upper lobe.  
*b.* Secondary carcinoma of mediastinum spreading out into lung substance.  
*c.* Greatly enlarged heart. Hypertrophy and hydropericardium.

free. A bilateral increase of shadows is more in favour of a tuberculous condition than a malignant growth. The tuberculous condition may, however, be present in a patient who subsequently develops a cancer or a sarcoma of the lung.

When disease has been shown to be present, it is often difficult to determine whether it is active or not. The distinction between *active* and *healed* tuberculosis has often to be made. In the former the mottling of the lung shadows is more marked, in the latter the appearances conveyed are more those of streaking, indicating a fibrotic condition. In some cases the shadows appear to be denser, and occasionally it is possible to make out areas of calcification. These may be seen at the apices, but more frequently at the root of one or both lungs.

Jordan has drawn attention to the appearances of the hilus shadows when he states that a great number of cases examined showed peribronchial thickening. He ascribes this condition in nearly every case to the presence of tubercle, and states that nearly all the cases he examined showed a condition of this kind. When these bronchial shadows are accompanied by mottling the condition is said to be active. He also contends that in the majority of cases the disease started at the hilus by an infection of the bronchial glands, and an extension from these glands takes place towards and involving the apex.

Bythell records the results of an examination of several hundreds of children. He found in a large percentage of these cases signs of tuberculous infection in the glands at the roots of the lungs.

While admitting that in the examination of a large number of chests these shadows are to be seen, the writer cannot agree that a diagnosis of tuberculosis can be made in every case. It is quite probable that other conditions than tuberculosis will give rise to peribronchial thickening. Thus chronic bronchitis, asthma, and any disease which leads to chronic irritation of these parts, may cause an increased formation of fibrous tissue around the bronchi; the repeated inhalation of dust and smoke, which is a concomitant of dwelling in towns, might quite easily cause a peribronchial thickening. These peribronchial shadows are frequently present in the chests of patients who are suffering from cancer, but it would be absurd to argue that in every case these increased shadows indicated the presence of a peribronchial invasion by cancer cells. Nor would it be reasonable to assume that the victims of cancer were also afflicted with tuberculosis.

The appearance of the chest shadows in many patients known to have cancer is strongly suggestive of peribronchial phthisis. It must be borne in mind that both diseases may be present in the same patient. It is quite possible that some of the patients may have had phthisis in early life, and what we see later are changes caused by the healing in the lung tissue. In the opinion of the writer there is undoubtedly a large number of cases, especially among patients at middle life or later, where the excess of fibrous tissue leads to very definite peribronchial shadows, which are due entirely to the thickening around the bronchi, and are diagnostic neither of tubercu-

losis nor cancer. In many of these cases the thickening of the bronchus may be seen on cross-section. It frequently happens, especially on the right side of the chest, that one or more nearly circular rings are shown. These are caused by a cross-section of the bronchus, where it bends nearly at right angles on its way to the deeper part of the lung.

The radiograph facing page 201 well illustrates the peribronchial thickening: it is from a case of malignant disease (Plate XXXVII., Fig. *b*), the branching of the bronchi being very well seen. The patient did not suffer from phthisis, nor had she any secondary deposits of cancer at the roots of the lungs. The grosser manifestations of tuberculosis of the lung require no lengthy description. A few radiographs will illustrate the appearances met with.

*Cavities* may readily be shown, especially when they are large and contain air, though the localisation of a small cavity in an area of consolidation is not always possible.

It must be borne in mind that other conditions than tuberculosis give rise to appearances identical in every respect. *Actinomyces* of the lung in the earlier stages is practically indistinguishable from a widespread tuberculous infection. In the later stages, however, more marked changes in the former might lead to a correct diagnosis. The nodules tend to become coarser than in miliary tuberculosis, and the tendency to suppurate should put us on guard when examining a suspicious case. It should also be noted that in actinomyces the tendency is for the disease to spread and involve the pleura, while localised abscesses of the chest wall would also occasionally occur.

The early stages of a sarcoma, when widely spread through the lung substance, might readily be mistaken for a miliary tuberculosis, but even in these early stages the occurrence of a rise of temperature in tuberculosis should be sufficient to lead to a correct diagnosis. In the later stages the small centres of growth rapidly increase in size, and appear to be much larger and coarser in structure than in tuberculosis. The history of the patient is also a help, as is also the presence of a primary lesion in other parts of the body.

Plate XXXII., Fig. *a* illustrates the mediastinal glands and lung substance in a boy aged six, who two years before had had his arm removed on account of a primary growth in the humerus. The secondary extension can be well seen in the glands and lung substance. The primary growth of the humerus is seen in Plate XXX., Fig. *a*.

**Syphilis.**—Syphilis of the lung or bronchi may cause some difficulty in diagnosis, especially if there be a tendency to the formation of gunmata, which might be mistaken for new growth or deposits of tubercle. The history of the case and a positive Wassermann reaction should clear up the diagnosis.

**Pneumonia.**—Acute lobar pneumonia, when well defined, is characterised by a large, comparatively dense shadow, occupying the portion of the lung involved. It may be quite localised to one lobe, or may involve the whole of one lung, while the other lung may show signs of congestion. It may be

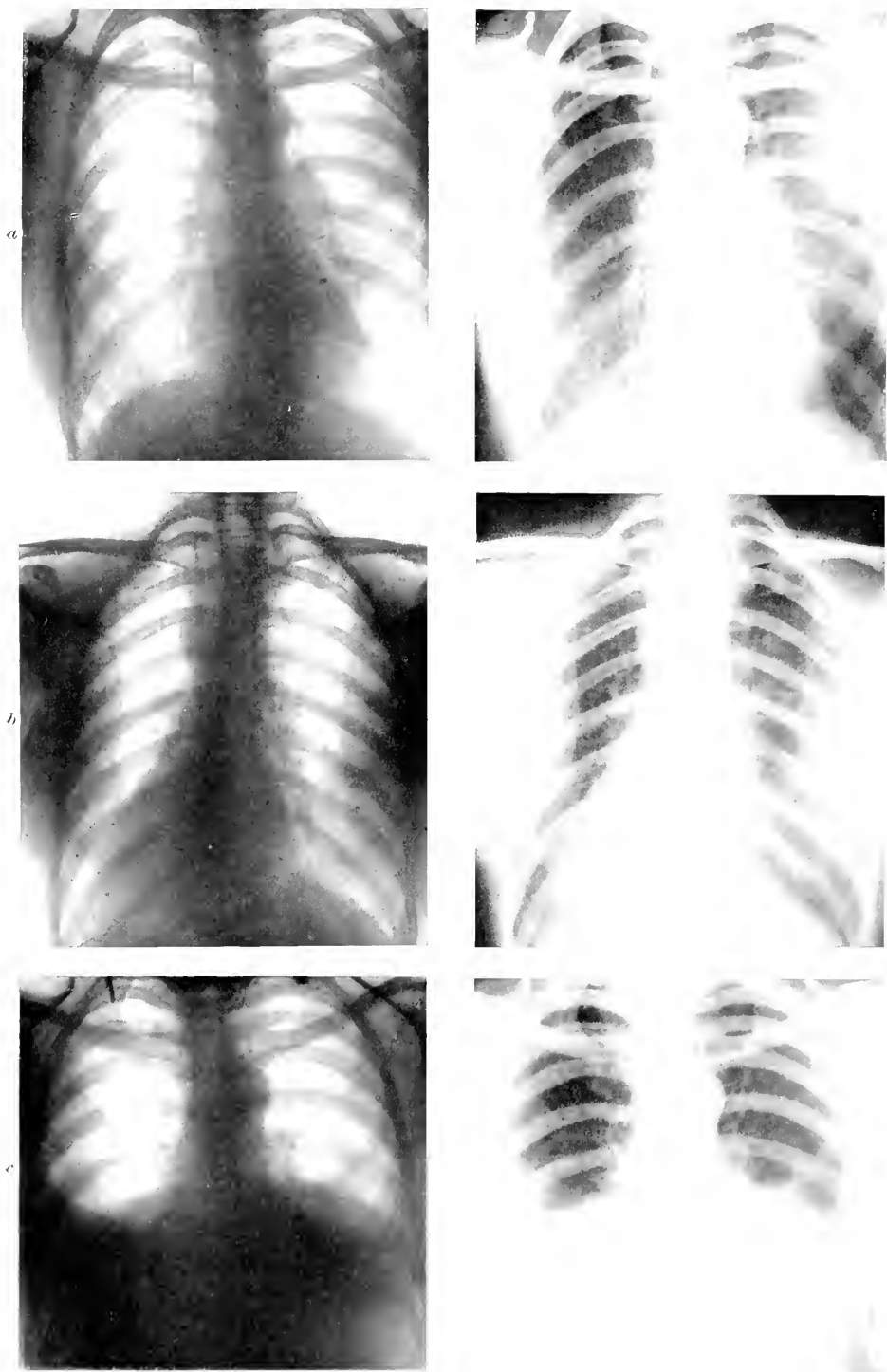

PLATE XXXVIII.—CHEST SHOWING CHRONIC PLEURISY WITH BI-LATERAL EFFUSION.

(From the same patient at several months' interval.)

*a.* Thorax taken with plate on anterior aspect.

*b.* Plate on posterior aspect. Shading at bases indicates involvement of pleura by carcinoma.

*c.* Double pleural effusion.

The patient had been operated upon for carcinoma of the breast, and died with signs of secondary deposits in the lungs and pleura.



accompanied by a pleural effusion. The clinical history and the feverish state of the patient should give a clue to the nature of the disease, and the subsequent resolution of the inflammatory process, with the slow subsidence of the shadow seen on radiographic examination, will help to clear up the diagnosis. An acute pneumonia may, however, not resolve quickly, and a shadow in the substance of the lung may be visible for several weeks after the inflammatory symptoms have subsided. Later on the affected portion of lung may become fibrosed. It is this class of case which gives rise to great difficulty in radiographic diagnosis. Acute broncho-pneumonia, when occurring in children, is another condition which leads to great difficulty in diagnosis, especially as an acute miliary tuberculosis gives nearly the same appearances on radiographic investigation.

**Interstitial Pneumonia.**—The forms of interstitial pneumonia which result in an increase of the fibrous tissue of the bronchi and lungs may also give rise to difficulties of diagnosis. The most commonly met with are : (1) Those following an acute pneumonia ; (2) those due to inhalation of dust ; (3) those due to the chronic action of bacterial poisons, *e.g.* tuberculosis, syphilis, actinomycosis.

**Pneumokoniosis.**—Interstitial pneumonia due to the inhalation of dust. There are three varieties of this according to the type of dust inhaled : (1) Anthracosis, coal-miners' lung ; (2) silicosis, stone-masons' lung ; (3) siderosis, needle-grinders' lung. In all these forms the foreign particles are inhaled and absorbed by the lymphocytes. They are deposited along the course of the lymphatics, forming nodules, and tending by chronic irritation to a marked degree of fibrosis. The lymph-glands are enlarged and indurated. In all these types the distinguishing feature, in contradistinction to that of malignant disease, is the more uniform distribution of patches of induration all over the lung and bronchial tracts.

**Abscess of the Lung.**—Abscess of the lung is occasionally met with, an area of consolidated lung tissue surrounding a central opacity. Radiographically, the appearances may simulate new growth, and an exploratory operation may be the only definite way of establishing a correct diagnosis.

**Bronchiectasis.**—This condition may be found in patients also suffering from chronic bronchitis and tubercular and malignant disease. A marked degree of dilatation and peribronchial thickening may cause shadows which are sometimes indistinguishable from those caused by a localised new growth.

**Differential Diagnosis in Diseases of the Pleura.**—Acute pleurisy is frequently characterised by an effusion of serum into the pleural cavity.

*Serous pleural effusion* is readily recognised. It may obscure the whole of the lung shadow, or the lung may be pushed upward and inward towards the middle line.

*Chronic Pleurisy.*—When this involves the parietal and visceral layers considerable thickening of the pleura may ensue, and this may lead to a degree of compression of the lung which may give the impression of a malignant growth.

*Secondary cancerous deposits* must also be looked for. The pleura is most frequently involved in these cases, thickening at the bases with or without an effusion being frequently met with, or the growth may extend outward to the lung substance. The earliest manifestation of a recurrence of cancer may be found in the pleura; the mode of invasion is described on p. 196. Radiographically, the recurrence may be shown as fine irregular opacities on the inner surface of a rib, and spreading along the pleura covering the rib, involving also the pleura covering the intercostal muscles. The shadow may show merely an increase in striation of the pleura, or it may appear as comparatively dense plaques. The mediastinal glands may be involved, being seen at the hilus of one or both lungs, where discrete glands may be demonstrated. The anterior mediastinum is occasionally involved, and in order to show these deposits it is necessary to take an oblique lateral view, when the enlarged glands may be seen just behind the sternum. Glands in the axilla and in the supraclavicular areas may also be met with, and should be shown on radiographic examination.

*Purulent Effusion, Empyema.*—This may readily be recognised. The shadow is very dense, and limited more or less according to the amount of pus present. Localised empyema may give appearances of a like nature, especially when the process is interlobar. Empyema which has been drained and followed by collapse of the lung is another condition which must be considered. The presence of an opening into the pleural sac will be a guide as to the nature of the case, but when a doubt exists, the cavity may be injected with bismuth emulsion and its exact size determined.

*Abscess of the Lung* is sometimes met with apart from an empyema. It may be deep-seated and very difficult to determine.

*Pyo-pneumo Thorax.*—Pus is present in the lower part of the pleural sac. A clear area is seen above the level line of pus, and lung tissue above the clear space.

*Foreign Bodies in the Pleural Cavity.*—Occasionally a drainage tube gets into the pleural cavity after an operation for draining the pleura. This can readily be located. Efforts for removal may be facilitated by a screen examination, and the forceps guided to the tube.

**Irregularities in the Outline of the Diaphragm**, to whatever cause they may be due, will often give appearances which lead to difficulties in diagnosis; moreover, a secondary involvement of the liver is not at all uncommon in cases where a growth in the lung exists.

*Tumours of the chest wall* may also have to be excluded.

*Hydatid cyst*, though not common in this country, must not be overlooked. The appearance of such a cyst is diagnostic, and a rounded, sharply-cut shadow in any part of the lungs should excite suspicion of hydatid disease. Cysts may arise from any of the structures composing the walls, *i.e.* sternum, ribs, costal cartilages, or spine. The appearances presented by a case of primary sarcoma arising from the inner aspect of a rib are typical of cyst—a rapidly growing sarcoma, which becomes hæmorrhagic, the walls of the growth consist of thickened pleura, and the cavity is filled with



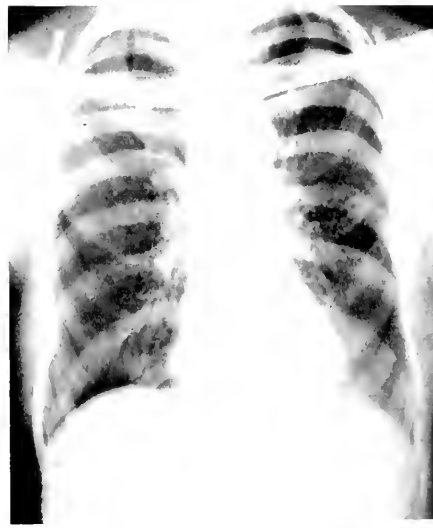

PLATE XXXIX.—CHESTS.

*a*, The arch of the diaphragm on the left side is high, the clear area is caused by gas in a distended stomach. Note fluid level at the lower limit of the clear area.

*b*, Extensive distribution of calcareous glands in thorax, axilla, and cervical regions. Healed tuberculosis of many years' standing.

*c*, Calcified glands at roots of both lungs. Healed tuberculosis.



blood-clot and growth. The X-ray appearances will show it to have a well-defined wall with semi-fluid contents.

## The Examination of the Heart and Aorta

**Variations in the Size, Shape, and Position of the Heart.**—The heart may be greatly enlarged in all directions, or it may show a marked hypertrophy of the left ventricle. Dilation of the right side of the heart may be distinguished from hypertrophy by the lack of density in the shadows.

The heart may be displaced to one or other side. It is sometimes seen on the right side of the thorax, the aorta in such a case bearing down to the right of the middle line.

The radiographic appearances of hydropericardium are characteristic. The cardiac outline is greatly enlarged in all directions, and there is a marked increase in the breadth of the shadow. It is bulged out, and gradually lessens in size towards the base of the heart, the shadow appearing to be widened at the apex where the heart rests upon the diaphragm. The outline of the heart may be faintly seen through the shadow caused by the dilated pericardium. The usual pulsation of the heart is lost or only seen faintly at the apex.

There are many variations in the appearance of the heart-shadow which have a definite significance in diagnosis. The small "nervous" heart of the neurotic patient is characteristic. In thin patients the contractions of the heart can be plainly seen, while in some instances, where there is irregularity in the heart-beat, the intermissions may be observed on the fluorescent screen. Similarly, in cases of Stokes-Adams disease, where there is a slowing of the pulse with alterations in the cardiac rhythm, these phenomena may readily be seen on the screen. The vertical heart seen in many cases of tubercle of the lungs is also a recognised feature in the radiography of the thorax. The heart may be enlarged irregularly in syphilis, gummata may cause shadows which might be mistaken for other conditions, and aneurism of the heart may cause an irregular shadow indistinguishable from gumma or new growth. The heart may also be the seat of a malignant neoplasm which may be primary or secondary to a lesion on the lungs, pleura, or mediastinum.

Cysts in the heart are rare, but the possibility of their occurrence should be kept in mind when an abnormal shadow is seen on the cardiac area. Hydatid cyst is extremely rare in this situation.

Screen examination of the heart is often very serviceable in diagnosis; the organ may be seen pulsating and the phases of the cardiac cycle studied.

**Thoracic Aneurism.**—The screen examination is very important, and should be employed in every patient sent for diagnosis. A radiograph is necessary also, but in this, as in all thoracic examinations, it must be insisted upon that the plate is merely a permanent record of what we see on the screen, and only a phase of what can be seen when a thorough screening is carried out.

The patient must be examined in at least three positions: (1) antero-posterior; (2) postero-anterior; (3) right lateral oblique, in which the patient faces the screen, and turns half round towards his right. In the first two positions the heart is well seen, but the normal aorta is almost entirely masked by the central opacity formed by the spine behind and the

sternum in front, with the exception of the left lateral aortic bulge, which is not evident in all cases.

In the case of aortic aneurisms there will be seen shadows of varying density and size, projecting to

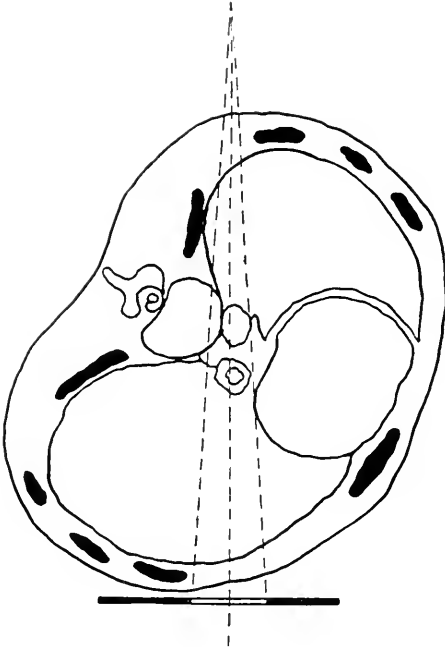

FIG. 156.—Position of thorax for lateral oblique position, to show position of plate and source of X-rays. This is a useful position for the examination of the aorta, oesophagus, and mediastinum.



FIG. 157.—Diagram to illustrate the appearance of thorax in semi-lateral position.

lying nearer to the front than the back indicates an aneurism of the ascending aorta, whereas a similar bulge to the left, and lying nearer the back than the front, indicates the presence of an aneurism of the descending aorta.

There are other methods of detecting the position and origin of an aortic aneurism:

(1) The tube may be moved from side to side or up and down.

(2) The patient may be rotated, and observations made of the change in shape of the shadows as the patient moves. The size of the shadow as seen in the ordinary methods of examination is misleading, the distortion caused by the nearness of the tube to the patient making the resulting shadows appear larger than they really are, the distortion being equal on all the structures recorded on the plate.

If the exact size of the organs is required, then we must use orthodiagraphy or tele-röntgenography. The former consists of an accurate drawing



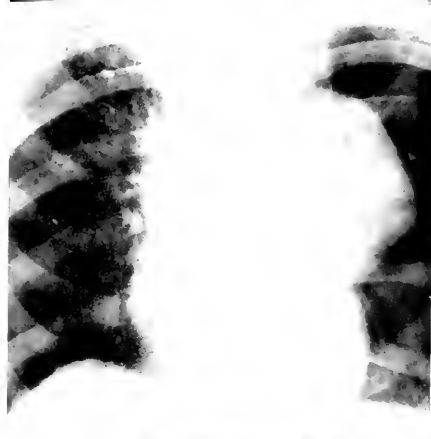
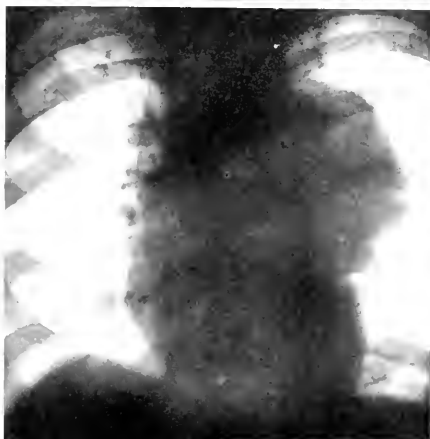
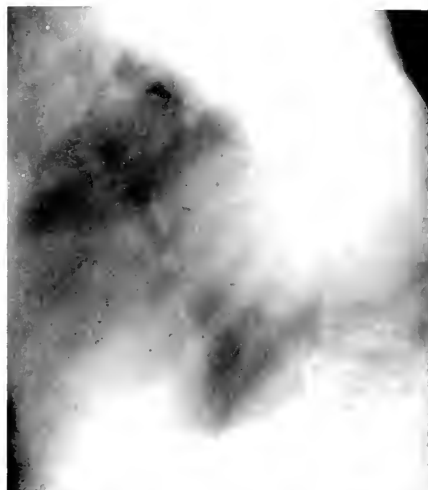

PLATE XL.—CHESTS SHOWING ANEURISM AND NEW GROWTH.

*a.* Aneurism of descending aorta, lateral.

*b.* Same case antero-posterior position.

*c.* Secondary growth in mediastinum, simulating aneurism.

of the size of the heart and aorta on a paper in front of or behind the patient, a somewhat complicated mechanical device being necessary. This method is very rarely used in this country, though it has been extensively used by

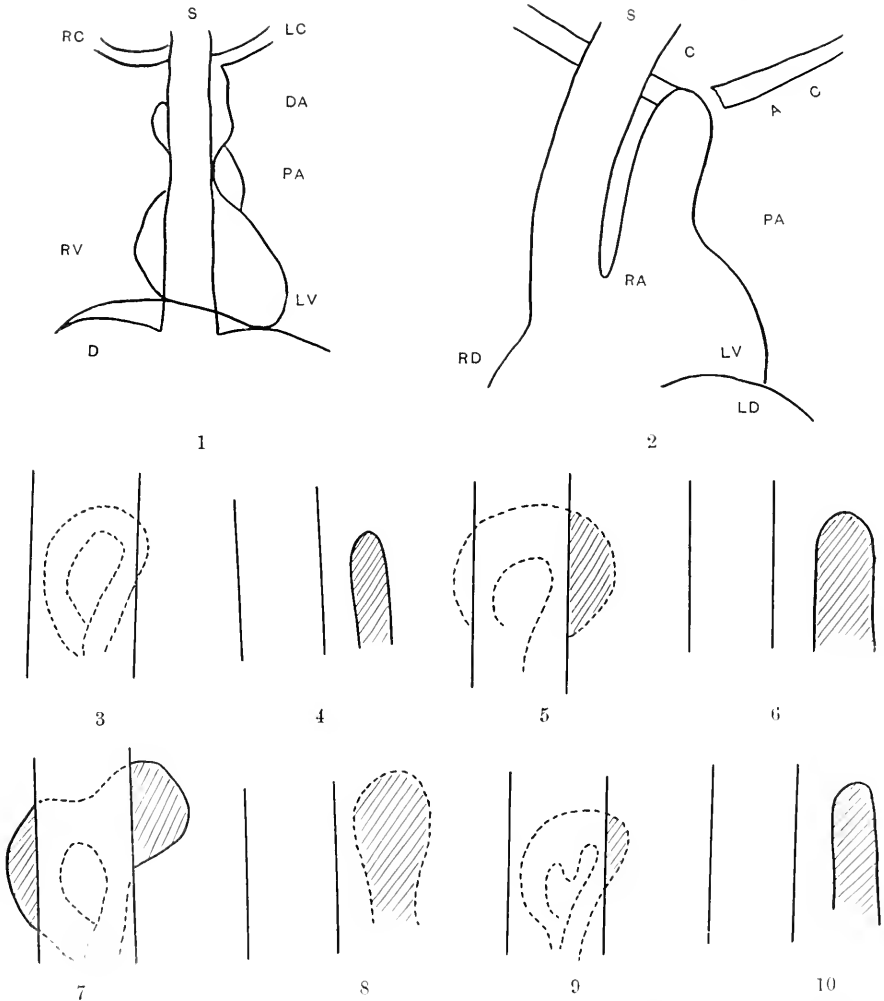

FIG. 158.—Diagrams to illustrate points of difference between dilated aorta and aneurism (after Holzknacht).

1. Normal heart and aorta seen from the front.
2. Normal heart and aorta, lateral oblique view.
3. Normal aorta in antero-posterior position.
4. Normal aorta in lateral position.
- 5 and 6. Appearances seen in dilated aorta. Antero-posterior and lateral positions.
- 7 and 8. The appearance seen in aneurism. Antero-posterior and lateral positions.
- 9 and 10. A small aneurism arising from the under aspect of the arch.

continental workers, notably by Groedal of Mannheim, who gives many interesting diagrams of typical cardiac conditions. He differentiates between the cardiac outlines in various forms of cardiac disorder, such as mitral stenosis, aortic insufficiency, etc.

Tele-röntgenography consists of making pictures at a considerable distance from the anti-cathode of the tube. When the distance is from 6 to 6½ feet the size of the shadows practically approaches the actual size of the organs. To obtain good pictures the exposure must be rapid, and this can only be obtained when a powerful installation is used.

The presence of pulsation must be carefully looked for. When found it is often difficult to determine whether it is caused by the pulsation of the aorta, or is the normal, or that communicated through a tumour in the mediastinum.

The most important position for the determination of aneurism of the aorta is the *right lateral oblique*, first described by Holzknecht in 1901. By its means we are able to demonstrate nearly all aneurisms; but the great value of the method lies in the demonstration of quite small aneurisms, which in the other positions are masked by the central opacity. To assume this position the patient stands with his back to the tube and his face to the screen or plate, and turns half round towards his right side, holding his arms above his head.

The important points to determine and to differentiate must be borne in mind. A dilated aorta will simulate an aneurism on the screen. It pulsates, and there is a widening of the aortic shadow. The normal aorta in a number of cases shows at the arch a distinct bulge to the left, which must not be mistaken for an aneurism.





## THE X-RAY EXAMINATION OF THE ALIMENTARY SYSTEM

The routine examination of the alimentary system is one of growing importance to the radiologist. So much can be ascertained by a thorough examination with the aid of the opaque meal that a lengthy description is necessary.

*Methods of Examination.*—(1) *Radioscopy* by means of the fluorescent screen. (2) *Radiography* by the action of X-rays upon photographic plates, a comparison being made of plates taken at intervals. Both methods are extremely useful, and neither can be dispensed with if a thorough examination and record of observations made are necessary for the completion of the investigation of any particular case. By these methods many observations of value may be made. The localisation of a foreign body becomes easy, while strictures in the œsophagus, and diseases of the stomach and bowels are now daily subjects for Röntgen examination.

### The Examination of the Œsophagus

The presence of diverticula of the œsophagus can readily be shown by the use of a quantity of bismuth emulsion and subsequent examination by screen and plates. The substances most commonly used are bismuth in the shape of (1) *Cachet*; (2) *Emulsion*; (3) *In food*, e.g. *sugar of milk*, *bread-crumbs*, *porridge*, etc. The cachet is open to the objection that unless it is very small it is apt to be arrested in a normal œsophagus. The best medium to employ is the emulsion, which may be of a fairly thick consistence.

The œsophagus may be examined in two positions:

1. *The Anterior*, when shadows of tumours may sometimes be shown.
2. *The Right Antero-lateral*.—This is the important position. The patient stands upright with the tube behind, and the fluorescent screen placed in front. The patient is then adjusted so that the position of the spine relative to the heart and aorta gives the maximum clear space between the two, this clear space containing the œsophagus. A little practice enables the operator to get the best position. The patient is told to swallow some bismuth food, and the operator keeps a careful watch for its passage down the œsophagus, this being indicated by a dark rapidly moving shadow passing down the œsophagus to enter the stomach. Any delay in transit should be

carefully noted. By this method of examination it is possible accurately to locate stricture of the œsophagus or obstruction at the cardiac end of the

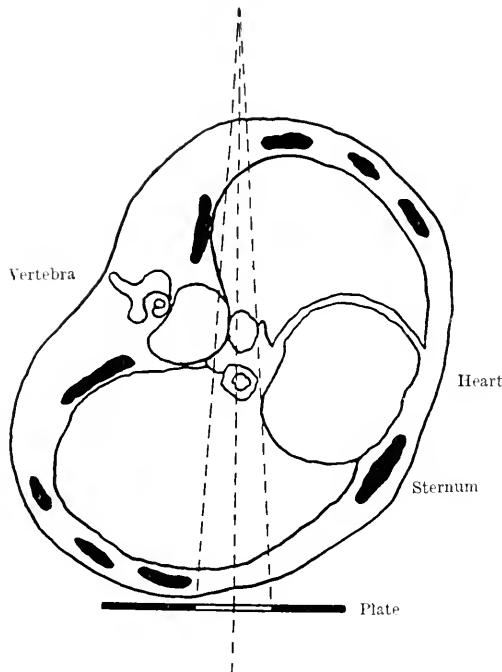

FIG. 159.—Diagram to show the position for lateral oblique examination of the thorax, and the path of the rays from tube to plate.

stomach. Foreign bodies may readily be detected in the œsophagus and accurately located.

### Examination of the Stomach

The examination of the stomach and intestinal canal has become one of the most important spheres of radiographic work. Its value in diagnosis is very great, but much remains to be done before a claim can be laid to expert knowledge in the interpretation of the results obtained. Even now, when the method has become general, authorities are found to hold conflicting views on the interpretation of the results. The technique followed by the observers differs in many respects, and this, no doubt, to some extent accounts for the conflicting opinions. In spite of the great difficulty in the way of correct interpretation, it is satisfactory to know that by means of X-ray examination it is possible to ascertain much about the position, size, and movements of the stomach, the process of digestion, and departures from the normal.

At the meeting of the Electro-therapeutic Section of the British Medical Association, held in Liverpool in 1912, a joint discussion took place with the



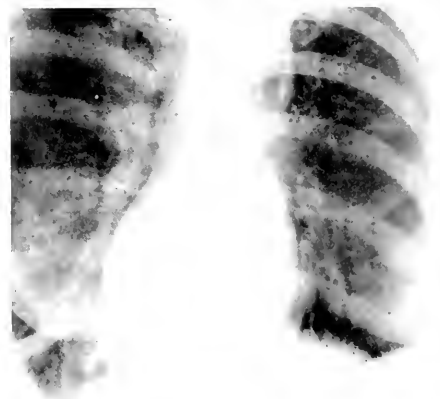
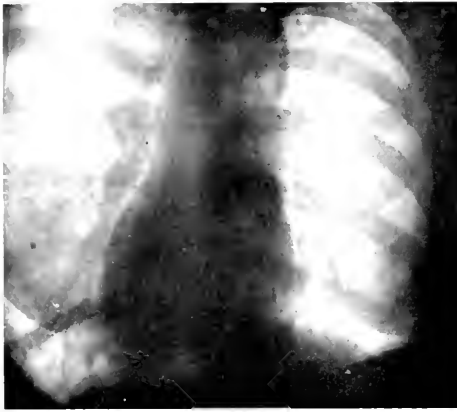

PLATE XII. CHEST SHOWING DILATATION OF OESOPHAGUS.

*a.* Oesophagus dilated and filled with food.

*b.* Oesophagus empty after an interval of 3 days, showing irregular shading in mediastinum.

*c.* Lower portion of dilated oesophagus containing bismuth food: point of stricture is seen, and food which has passed into the stomach.

Anatomical Section on the normal stomach. It was almost unanimously agreed that radiography had modified the opinion held formerly as to the position of the normal stomach. Hertz describes three positions of the stomach: (1) When one-third full; (2) when half full; (3) when fully distended.

The following is quoted from Hertz's paper:

**Anatomy of the Stomach**

*The Subdivisions of the Stomach.*—

The œsophagus enters the stomach very obliquely, the acute angle it forms being called the incisura cardiaca. The cardiac orifice, though not surrounded by a definite sphincter, has a much smaller diameter than the lower extremity of the œsophagus, as great a period being consequently required for the passage of a mouthful of food through the cardia as for its passage down the whole length of the œsophagus.

The stomach can be divided into a larger cardiac part and a smaller pyloric part. The cardiac part consists of the fundus and body, the fundus being the segment of the stomach which lies above a horizontal

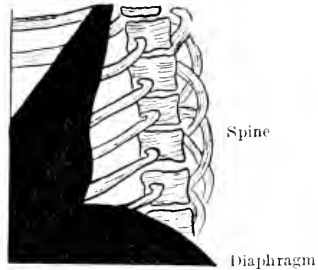

FIG. 160.—Diagrammatic representation of the lateral view of thorax.



FIG. 161.—The appearances seen on the fluorescent screen after the patient has taken bismuth food are shown diagrammatically. The shadows represent the passage of a number of mouthfuls of food down the œsophagus; when a large quantity is swallowed in successive acts of deglutition, a continuous line of dark shadow is seen. This may be seen to vary in diameter, corresponding with the contractile movements of the œsophagus.

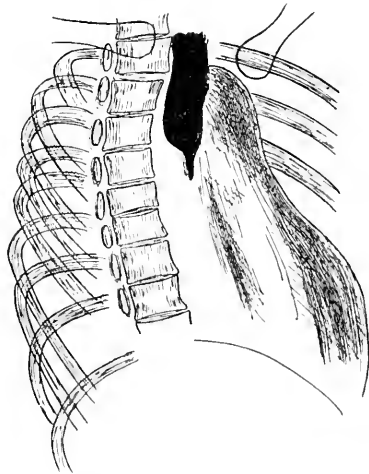

FIG. 162.—Diagram to illustrate the appearance seen in a semi-lateral view of the thorax. The dark shadow at the top is caused by bismuth food in a dilated œsophagus. The point of stricture is seen at the lower extremity of the dark shadow.

plane passing through the cardiac orifice. The body is situated entirely to the left of the middle line. In the erect position it is either vertical, or, especially in men, slightly inclined towards the right; in the recumbent position it

is always rather more oblique. Its axis is inclined forwards as it passes downwards.

The incisura angularis, a well-marked depression on the lesser curvature, most obvious in the erect position, separates the body from the pyloric part of the stomach, but there is no definite depression on the greater curvature marking

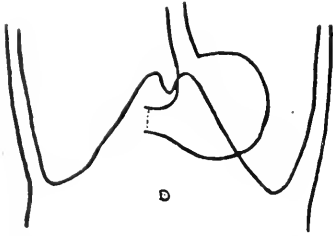

FIG. 163.—Diagram from a text-book of anatomy showing position of stomach. (Hertz.)

This shows what was supposed to be the shape and position of the stomach before the radiographic method of investigation was introduced. It is worthy of note, however, that some anatomical writers described a different shape and position. The Edinburgh Stereoscopic Atlas of Anatomy illustrates a stomach which for shape and position might easily be an exact reproduction of the normal stomach as demonstrated by the radiographic method.

attains its greatest development at the duodeno-pyloric junction, where it is separated by a connective tissue septum from the circular coat of the duodenum. Only a few of the longitudinal more superficial fibres are continuous with those of the duodenum, the majority forming distinct fasciculi, which penetrate the substance of the sphincter, in which some end, whilst others reach the submucous tissue.

*The Empty Stomach.*—In the empty condition the upper third of the stomach is pear-shaped and contains gas. The rest of the organ passes to the pylorus in the form of a collapsed tube. The pylorus is situated in the transpyloric plane, midway between the upper margin of the manubrium sterni and the upper margin of the symphysis pubis in the middle line, or very slightly to the right. The greater curvature in the erect position reaches the level of the umbilicus or slightly above it. In the horizontal position the stomach lies more obliquely, and the greater curvature scarcely reaches below the pylorus.

*The Half-filled Stomach.*—When the stomach is partially filled by a standard bismuth meal, half a pint in volume, its body is almost uniform in diameter, and its axis corresponds in position with that of the empty organ. As the diameter of the fundus is rather greater than that of the body, a slight constriction marks the separation between the two parts of the stomach. The diameter of the

the separation. The pyloric part of the stomach consists of the pyloric vestibule and pyloric canal, the termination of which is the pylorus. The pyloric vestibule is directed upwards and slightly backwards as it turns towards the right; it generally reaches just beyond the middle line. The pyloric canal is about 3 cm. in length; it is directed more definitely backwards than the pyloric vestibule, but is inclined slightly upwards and to the right. Its termination projects into the duodenum, producing a striking resemblance to the portio vaginalis of the cervix uteri.

The position of the pylorus is only occasionally marked by a slight constriction on its outer aspect; it can be more readily recognised by a venous ring, the position of which corresponds closely with it. Both the circular and longitudinal muscular coats are much thicker round the canal than in the rest of the stomach. The circular fibres are disposed in the form of a sphincter, which

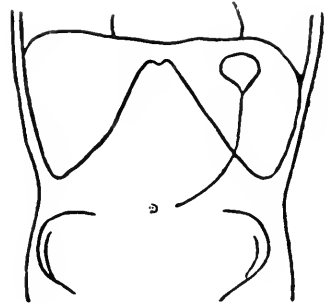

FIG. 164.—The position of the empty stomach. Diagrammatic representation of the screen examination. (Hertz.)



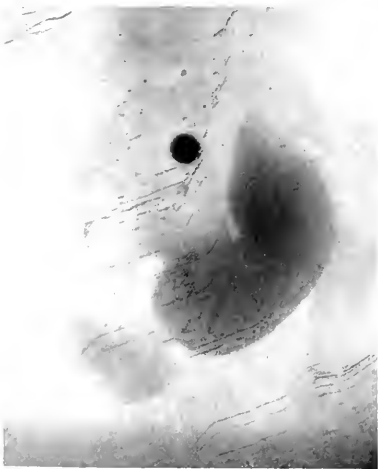

PLATE XLII.—STOMACH SHOWING PYLORIC STENOSIS.

- a.* Marked delay in emptying caused by cicatricial contraction resulting from healed gastric ulcer.  
*b.* Four hours after—food taken. Shows food passing along duodenum.  
*c.* Eight hours after—food still in stomach. The organ is not now contracting well.



pyloric vestibule becomes slightly smaller as it approaches the pyloric canal. The pyloric canal is always closed, except when chyme is passing through it into the duodenum, although its cavity is generally more or less expanded in post-mortem specimens. Even when the sphincter is relaxed for the passage of food, the canal is so narrow that nothing more than a very fine line can be seen with the X-rays, joining the gastric and duodenal shadows. In the vertical position the greater curvature almost always reaches below the umbilicus, the average distance being  $2\frac{1}{2}$  cm. in men and 5 cm. in women. In the horizontal position the greater curvature is on an average 6 cm. higher, its lowest point being conse-

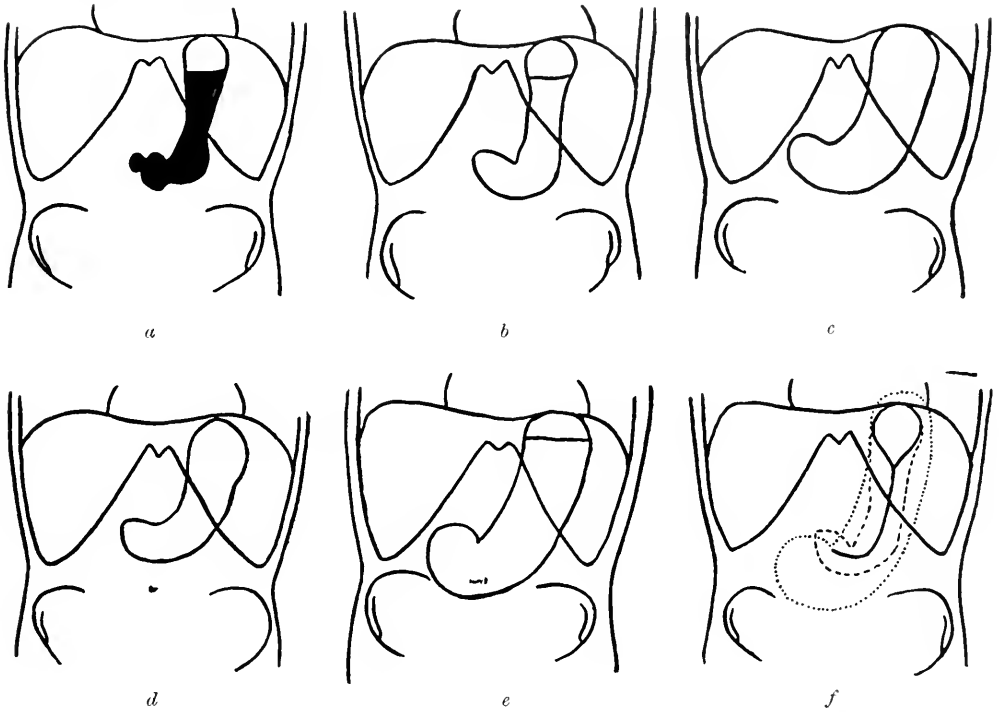

FIG. 165.—Diagrams showing stages of filling of stomach by opaque meal. (After Hertz.)

- (a) Stomach as seen after a bismuth meal showing depressions produced by peristaltic waves.
- (b) Half-filled stomach in vertical position, depressions caused by peristaltic waves not shown.
- (c) Filled stomach in horizontal position as seen with the X-rays.
- (d) Half-filled stomach in horizontal position as seen with the X-rays.
- (e) Filled stomach in vertical position as seen with the X-rays.
- (f) Superimposed outlines of empty, half-filled, and full stomach as seen with the X-rays in the vertical position.

quently above the umbilicus. The junction between the horizontal and descending portions of the duodenum is fixed, but the pylorus is mobile, and in the half-filled stomach it is situated distinctly lower in the erect than in the recumbent position. The fundus does not drop from the diaphragm when the erect position is assumed, but, as the diaphragm itself falls slightly, the fundus is also a little lower in the vertical than in the horizontal position.

*The Full Stomach.*—Owing to the greater resistance of the structures in contact with the lesser curvature than those in contact with the greater curvature, when the stomach is filled with a large meal its walls expand more in the direction of the latter than the former, so that its axis comes to lie outside, and below

that of the empty and the half-filled stomach. The left dome of the diaphragm is pushed upwards until it reaches as high as, or higher than, the right dome. The diameter of the body of the stomach is so greatly increased that the constriction between it and the fundus disappears. The collection of gas—the “magenblase” of the German radiographer—is wider and more shallow than that of the half-empty stomach. The diameter of the body is uniform; that of the pyloric vestibule is almost as great as that of the body, but it diminishes as it approaches the pyloric canal, which invariably remains closed. The pyloric vestibule is so greatly widened that it reaches considerably beyond the middle line, and when viewed from the front completely hides the pyloric canal, which now points either directly backwards, or even slightly towards the left, in spite of the fact that the pylorus itself also moves slightly towards the right.

**The Opaque Meal.**—The examination of the stomach is carried out by means of the “Bismuth Meal,” or, to use a more general term, the “Opaque Meal.”

The preparation of the patient prior to the ingestion of the bismuth meal is a point of considerable importance. Authorities differ as to the exact procedure, and will probably continue to do so, in spite of efforts to establish a standard opaque meal, and a routine method of preparation and examination. While such widely diverse methods as those suggested by Hertz, Morton and others, and the special technique recommended by Jordan, are used, great discrepancies in results must follow. Given the use of a standard opaque meal, a routine method of preparation, and a definite system of examination, it should be possible for individual observers to establish a normal condition of affairs, and from this we should be able to demonstrate marked departures from the normal. In time the results of many observers would harmonise, and definite statements could be made by comparing a large number of such results.

The method of preparation of the opaque meal described by Dr. Morton, in opening a discussion on the standard opaque meal, is that followed by the majority of operators. The average quantity of bismuth oxychloride or carbonate or barium sulphate is about three ounces, the basis of the meal consisting of bread cut into small cubes, the diluting medium being warmed milk sweetened with sugar. The milk is poured over the bread cubes, and the whole is gently mixed, the opaque substance used being gradually added, and the stirring continued until a fairly stiff mixture is obtained. The patient takes the whole of this mixture, and the routine examination is proceeded with.

A preliminary examination should be made of the abdomen before the patient takes the meal, and a plate taken for comparison later on. By this method it is possible to eliminate other conditions than gastric or intestinal lesions. Thus stone in the kidney pancreas or gall bladder may be shown. Dr. Case of Battle Creek has obtained a number of excellent plates of gallstones in the gall bladder and bile ducts in the examination of a large number of stomach cases. The stomach should be observed while the opaque meal is passing into it, as valuable data of the normal and abnormal condition of the alimentary tract may thus be obtained.

Franz Groedel uses 400 grammes of wheat-meal porridge with 10 per cent of bismuth subnitrate. This preparation of bismuth, however, is never used now, the carbonate, oxychloride of bismuth, and more recently sulphate of barium being substituted, care being taken that the latter salt is absolutely pure. He gives the following results :

Stomach emptied in 2 to 4 hours after the meal.

Small intestine emptied in a maximum of 4 to 5 hours after the meal.

Cæcum begins to fill in 2 to 3 hours after the meal.

Cæcum filled in 4 to 6 hours (right flexure).

Transverse colon filled in 4 to 12 hours (left flexure).

Ampulla of rectum reached at latest in 24 hours.

Rieder, using carbonate of bismuth (pure), gives the following results :

Stomach empty in 3 to  $3\frac{1}{2}$  hours after the meal.

Small intestine begins to fill in  $3\frac{1}{4}$  to 4 hours after the meal.

Small intestine empty in 8 to 9 hours after the meal.

Hertz, using oxychloride of bismuth, gives the following results :

Cæcum visible  $4\frac{1}{2}$  hours after the meal.

Left flexure visible  $6\frac{1}{2}$  hours after the meal.

Right flexure visible 9 hours after the meal.

Rectum visible 18 hours after the meal.

Groedel, using a meal composed of 250 grammes of barium sulphate, 20 grammes of maize flour, 20 grammes of sugar, 20 grammes of chocolate or cocoa, and 400 c.c. of water, gives quite different results :

Stomach empty in  $1\frac{1}{2}$  to 2 hours after the meal.

Cæcum begins to fill in 1 to  $1\frac{1}{2}$  hours.

Cæcum filled in 2 to 6 hours (right flexure).

Transverse colon filled in  $4\frac{1}{2}$  hours (left flexure).

Rectal ampulla reached 24 hours at latest.

These figures show that with barium sulphate the stomach empties itself just twice as fast as with bismuth subnitrate, and that the carbonate and oxychloride have practically the same action as the subnitrate.

Groedel concludes that bismuth somewhat decreases the normal motility of the stomach, and he considers that barium sulphate is the best contrast material for the Röntgen examination of the stomach, and that bismuth leads to false conclusions, since we are dealing only with comparative results.

Corresponding to the increased motility of the stomach we get with barium sulphate an increased flow of well-contrasted chyme in the small intestine, which is markedly more pronounced than after the bismuth meal. This, he holds, is a great advantage for many diagnostic purposes. The duodenum and small intestine are flooded with opaque chyme, and show as ribbon-like shadows, almost as broad as the large intestine. Other advantages of the more rapid emptying of the stomach are that the cæcum is

already visible an hour to an hour and a half after the meal, which is much earlier than is the case with the ordinary bismuth meal, and that the small intestine is emptied, and the ascending colon filled, much more quickly.

The four opaque substances used have none of them any great influence on the motility of the large intestine, the time of evacuation being approximately the same in all four cases. Hence barium sulphate is the most suitable opaque substance for the Röntgen examination for the following reasons :

(1) It gives sufficient data for the determination of the physiological motility of the alimentary canal.

(2) It is much cheaper.

(3) It stimulates the flooding of the small intestine with a well-contrasting chyme, thus greatly facilitating the Röntgen examination.

(4) The taste of the barium porridge is much pleasanter than that of any other of the opaque meals.

(5) The use of the barium meal is a saving of time, since in consequence of its stimulating action the examination may be made at shorter intervals.

It would appear that none of these four substances necessarily gives the correct time factors on which to base definite conclusions regarding the physiological action of the stomach and intestine, the bismuth salts appearing to delay the motility of the stomach, while the barium sulphate stimulates it. The conclusions we wish to draw, however, are comparative only, therefore it matters little which salt is employed so long as the same one is used in all cases.

A useful routine method, for the examination of the intestinal canal, which may be varied to suit the particular case and convenience of the operator, may be formulated :

(a) 9 A.M. Examination of the stomach in the process of filling. Record of the shape and position of the full organ. Screen examination is usually sufficient, but any marked departure from the normal should be radiographed in order that a permanent record may be obtained.

(b) 9.15 A.M. Examination of the duodenum, screen and plate if necessary.

(c) 10 A.M. *One hour after the meal.*—Determination of the degree of gastric evacuation. At this stage the small intestine is well seen. In some cases the cæcum may be seen commencing to fill.

(d) 11 A.M. *Two hours after the meal.*—The normal stomach is usually completely empty, the cæcum well filled.

(e) 1 P.M. *Four hours after the meal.*—Small intestine empty ; ascending colon visible.

(f) 7 P.M. *Ten hours after the meal.*—The large intestine is visible as far as the left flexure.

(g) *Twenty-four hours after the meal.*—The large intestine is filled as far as the rectum.

These are roughly the times for a barium meal ; when a bismuth salt is used the time given must be proportionately lengthened.

There are several variations from the routine which may be employed to suit individual cases, *e.g.* the screening may be greatly prolonged when it is desirable to make observations on the motility of the stomach, or in cases of irritable stomach with or without duodenal ulcer. In pyloric ulcer or cancer of the pylorus valuable observations may be made by the screen method.

Dr. Jefferson, working in the X-ray department at the Cancer Hospital, London, has obtained a number of most interesting plates of these conditions. Conditions of the alimentary tract commonly met with will best be shown

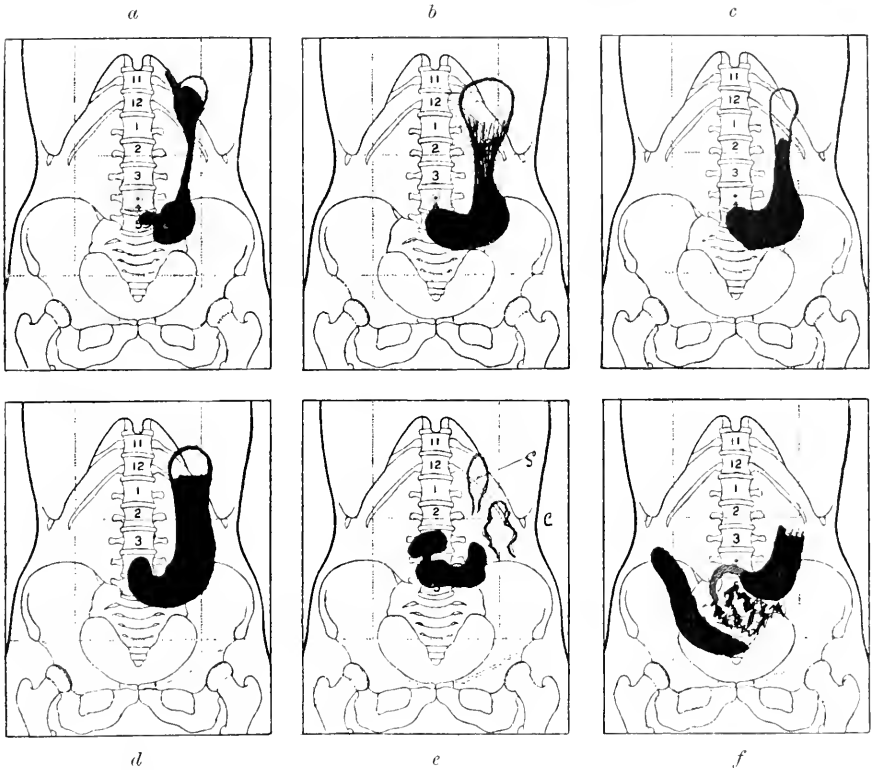

FIG. 166.—Diagrams to illustrate the stages of a bismuth meal.

*a, b, and c* show the stomach in process of filling with the bismuth food.

*d* shows the fully distended stomach immediately after completion of the meal.

*e*, Several hours after: Food passing from the stomach through pylorus into duodenum; food in small intestine.

*f*, Stomach nearly empty; food in small intestine (ileum), and commencing to fill up the caecum.

by taking a number of plates dealing first with the normal and later with the departures from the normal.

The radiographic method is of the greatest value when a succession of plates can be obtained, as the stomach may be observed during the process of filling. Small quantities may be watched passing into the organ and taking a definite course along the lesser curvature.

**Modifications of the Opaque Meal for Special Investigations.—**

The bismuth or barium sulphate may be made very thin and a small quantity given when we wish to test the motility of the stomach carefully. Having observed the movements, the next step is to fill the stomach completely and determine its position and size, plates or drawings being taken as need arises.

There are other modifications of the bismuth meal which are useful. Haenisch recommends the following method for the investigation of the large intestine :

Thoroughly mix 500 grammes of warm water with 300 grammes of kaolin and 150 grammes of barium sulphate ; then add 500 grammes more of warm water, and finally 150 grammes of barium. To inject, introduce a soft rectal rubber tube a few inches into the rectum. To the outside end of this attach a few inches of glass tubing (thus enabling the injection to be seen), from which india-rubber tubing is led to a douche can. Place the barium solution in the can, and raise it to allow the injection to flow. The patient is lying on a couch with the X-ray tube below, and the injection is watched upon the fluorescent screen ; then by lowering the can the injection will flow from the bowel, and thus any abnormal condition can be studied with the solution flowing in either direction.

*Haudek's Double-meal Method.*—A bismuth meal is given at 7 o'clock, and the stomach is examined at 1 o'clock for residue or otherwise, and the bowel for the position of the meal. A watery infusion of bismuth is then given, to determine the size, shape, and motility of the stomach itself. This method allows of the whole examination being made at one sitting, and certainly shortens the time during which the patient is under observation. On the other hand, it is not reliable, and in some cases many observations require to be made. This method is capable of further modification. Instead of the watery infusion a complete barium meal may be given. The whole of the intestinal tract may then be shown at different times.

**Precautions to be observed in the Conduct of the Examination.—**

With the screening-stands and tables now in use, the distance is sufficiently great to prevent any serious damage to the patient with prolonged screening ; but where, as often happens, the operator is not fully equipped for this class of work, and where his apparatus is not sufficiently powerful to ensure satisfactory results, he is tempted to approximate the tube and patient as closely as possible, and, if great care is not exercised, the skin in sensitive patients may be severely damaged. Under such conditions prolonged screening should be avoided. When it is necessary to screen thoroughly the patient should be at least two feet from the anti-cathode of the tube, and even then the interposition of a thin aluminium filter will be a safeguard. In cases of doubt it is better to test by placing a Sabouraud pastille or Kienböck paper in the position occupied by the patient, and the tube allowed to run for the length of time which would correspond to the full examination contemplated. A comparison of the pastille or paper with the usual standards will show approximately the dose which would be administered to the skin

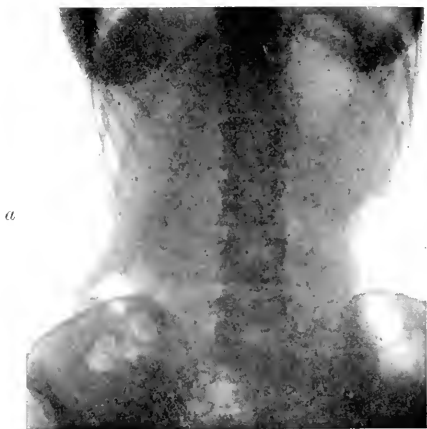

PLATE XLIII.—STOMACH AND COLON SHOWING VISCEROPTOSIS.

*a*, Abdomen before the meal; this shows the shadows caused by gas in the stomach and large intestine.

*b*, Stomach well filled, situated low down in the pelvis, elongated.

*c*, Stomach emptying slowly.





surface during the examination. In this way it is possible to save damage to the patient and anxiety to the operator.

**Radiographic Appearances.**—Holzknecht, in an exhaustive paper on the bismuth examination of the stomach, groups radiographical and clinical signs under one "symptom complex," so as to show their true diagnostic value.

This is a most important step in technique. Clinical signs and symptoms should always be considered together with the radiographical findings, if we wish to get the best value from the examination. A consideration of the clinical signs will often determine the exact method of investigation we should employ, and will save time.

He describes a number of groups; two examples will illustrate the method:

**Symptom Complex A.**—(1) Bismuth residue six hours after meal; (2) Normal shadow of stomach seen on the screen; (3) Achylia.

Diagnosis: a small carcinoma of the pylorus.

**Symptom Complex B.**—(1) Small bismuth residue after six hours; (2) Sensitive pressure point and resistance in the pars media; (3) transverse contraction of the pars media; (4) diverticulum, without an air bubble in the small curvature; immovable.

Diagnosis: a callous ulcer of the small curvature of the pars media.

He lays great stress upon the importance of hyperacidity or otherwise, and many of the X-ray diagnoses are based upon the X-ray findings, plus or minus the acidity. Thus in Symptom Complex A the diagnosis is made on the following points: (1) As long as the pylorus is free, achylia is always associated with hypermotility in an empty stomach in from two to three hours; (2) A residue after six hours must mean organic obstruction; (3) Spasm of the pylorus is never associated with achylia but with hyperacidity.

The X-ray findings may be diagnostic of simple ulcer or malignant disease. In the former the ulcer is rarely seen, but if the case is observed on the screen the presence of the ulcer may be suspected from the absence of shadows indicating the passage of food through the pylorus. In malignant disease involving the lesser curvature and spreading round the pylorus, the latter point is more or less fixed, and held higher up than usual; food may be seen passing through the stricture; a sharp and persistent angle or irregularity in the pyloric region is generally indicative of malignant stricture; finally, a shadow of the growth may at times be seen on the radiographs.

Rieder and Rosenthal have demonstrated the normal and abnormal contractions of the stomach wall by a method of cinematography. They take 8 or 9 pictures in rapid succession. An outline sketch is taken of each on transparent paper, the whole are superimposed, and a picture obtained of a peristaltic wave passing along the whole organ. Definite departures from the normal are indicated by an arrest of the contraction wave at one particular spot, showing the presence of an ulcer, which may be simple or malignant.

The value of an X-ray examination of the stomach is great, but reliance should not be placed on it alone. Repeated examination should be made and chemical examinations carried out simultaneously, and, lastly, full consideration should be given to the history of the case and the palpation of the stomach at the time of the examination.

**Variations in the Position and Size of the Stomach.**—The normal stomach is variable in form and position. There are certain types which must be considered normal since each is capable of performing its normal function. Later anatomical studies undoubtedly prove that the living stomach is correctly shown by the Röntgen picture. Variations in the shape and size of the normal stomach have been described; but radiographic interpretation would be facilitated if the division into groups according to muscular tone were adhered to in the future, these groups being of the hypertonic, orthotonic, hypotonic, and atonic forms. These are illustrated diagrammatically below.

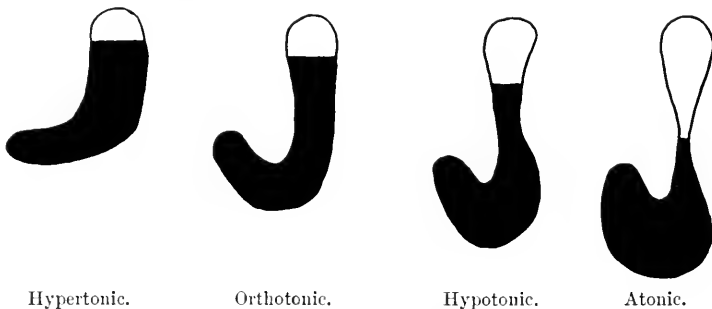

FIG. 167.—Types of stomach.

The emptying time, or normal period taken to empty these different types of stomach of the opaque meal, is an additional aid in differentiating each type. The hypertonic requires from two to three hours to empty itself, the orthotonic three to five hours, the hypotonic four to six hours, and the atonic six to eight hours.

The form of the normal stomach and its position depend largely upon the shape of the upper abdomen and the general anatomical characteristics of the individual. When the intercostal angle is wide and the upper abdomen is broad, the stomach assumes an oblique position. With a narrow upper abdomen and a more acute intercostal angle, the stomach is perpendicular. Thus, in some individuals an atonic type of stomach is normal, *i.e.* if its function is not delayed, while the same type in an individual of a different build, but incapable of emptying itself, is the result of a ptosis. Again a hypertonic form of stomach may be found where the abdomen is broad and the intercostal angle wide, and yet it will be found to be orthotonic or even hypotonic.

**Functional Disturbances of the Stomach.**—*Tonicity of the Stomach.*—The phenomena observed while the opaque meal is passing into the stomach. The manner in which the opaque meal enters the stomach is



PLATE XLIV. STOMACH AND COLON SHOWING VISCEROPTOSIS.

- a.* Six hours after ingestion of food, stomach still containing considerable quantity of food.  
*b.* Two hours later, eight hours after ingestion, stomach contracting vigorously on the bismuth residue.  
*c.* Twenty-four hours after meal: food in colon.



an indication of its muscular tone. The empty normal stomach lies in the form of a collapsed tube, with its walls in contact, except in the fundus, which contains the so-called *magenblase*. (See Fig. 164.) A portion of the opaque meal is first seen in the upper part as a funnel-shaped shadow, which is quickly forced downwards, separating the walls, and finally reaching the sinus, and filling the pyloric canal. The length of the stomach remains fixed, while the corpus, sinus, and pyloric canal increase in girth, and accommodate themselves to the amount of the meal ingested. This type of filling phenomena is characteristic of the orthotonic stomach. In contrast to this, the opaque meal in entering an atonic stomach seems to fall through the corpus directly into the sinus. The direction of the passage of the meal is outwards and downwards to the left.

In a markedly atonic stomach the distension commences in the sinus, the opaque meal collecting there in a half-moon form, while the walls of the body remain in contact, and the fornix filled with gas preserves a more or less oval form. Gross changes in the contour of the stomach can be observed during the ingestion of the opaque meal. The benign and the malignant hour-glass stomach differ entirely in filling phenomena from the normal stomach.

*The Motility of the Stomach.*—Definite conclusion as to the motility of the stomach can be arrived at from the study of the swaying intensity and form of the peristaltic waves, and the time required for the opaque meal to pass, when combined with the information given by the shape, position, and form of the residue remaining in the stomach. These peristaltic waves can be shown on the fluorescent screen. Rieder and Rosenthal have shown the complete wave by means of a number of radiographs taken in rapid succession. The late Dr. Leonard showed that there is a constant change in the length and breadth of the stomach during every cycle of respiration. It has been noted by surgeons during operations under anæsthetics, that while peristalsis is absent and the sphincters are relaxed, the contents of the stomach are ejected into the duodenum in jets synchronous with the respiratory movements.

The form and depth of the peristaltic wave differ in the varying types of stomach, and in the same stomach with the patient in different positions. It also varies with the character of the ingesta.

*The Time taken by the Stomach to Empty.*—The relation of the emptying time of a stomach to that of the normal type is the most accurate way of determining its motor efficiency. Thus, as already stated, it has been determined that the emptying time of the four types of stomach is as follows :

A standard Rieder meal of 350 grammes of food and 50 grammes of bismuth should pass through the hypertonic stomach in two to three hours, the orthotonic in three to five, the hypotonic in four to six, and the atonic in six to eight hours ; the presence of a residue of bismuth in a stomach of any one of these types, after the normal time for that type, shows that there is deficient motility. Differences will be found to occur according to (a)

modifications of the quantity of food and bismuth, (*b*) the substance used to render the meal opaque, and (*c*) the placing of the patient in different positions. As far as possible the examinations should be made in the upright position, the recumbent position being used in most cases as a check observation. No other food should be taken by the patient until the stomach has emptied itself, or until the observer has determined that no further observation on the emptying time of the stomach is necessary.

**Pathological Conditions of the Stomach.**—The excellent summary of these conditions by the late Dr. Lester Leonard, in his report to the Radiology Section of the International Congress, held in London in August 1913, is so complete that this part of the work will be largely modelled on his lines.

*Disturbances of Secretion.*—The Schwartz capsule may be employed to estimate the amount of free hydrochloric acid in the stomach. This capsule is made of gold-beaters' skin of known thickness, containing 4 grammes of chemically pure bismuth and 25 grammes of pure neutral pepsin; the latter is added to hasten the digestion of the capsule, so that it will occur within five hours, and to make the time of digestion entirely dependent upon the amount of hydrochloric acid by providing an excess of pepsin. By experiments *in vitro* the time has been determined which is required to digest the capsule with fixed amounts of free hydrochloric acid. These results were found to conform to the time taken to digest these capsules in a large series of cases. The patient is given in the morning, while fasting, a test meal consisting of 200 grammes and a measured quantity of bread. The capsule is taken and observations made at regular intervals by means of the fluorescent screen, in order to see when the capsule is digested as indicated by dissipation of the bismuth.

*Pathological Changes in the Form and Position of the Stomach.*—While studying the changes in position and shape of the stomach itself, one must bear in mind those changes due to pressure from without. Among these may be mentioned pregnancy; tumours of the viscera, such as fibromata, cystic conditions, or tumours involving the abdominal walls. The presence of peritoneal bands or adhesions must also be considered. These may be suspected when during an examination any particular part of the organ appears to be unduly fixed, or when the whole organ is relatively higher than normal. These adhesions are a frequent accompaniment of healed gastric ulcer, inflammatory conditions of the gall-bladder, etc.

*Ptoxis.*—The most obvious and frequent change noted in the stomach is that of ptoxis. In true gastropnoxis the bismuth meal is seen to fall through the stomach quickly, the lack of muscular tone allowing the food to pass rapidly through and collect in the sinus. The pylorus and œsophagus with the fornix are firmly fixed by their ligaments, and the ptoxic stomach therefore increases in vertical length, the bismuth meal distending the lower portion of the stomach, while in the median part of the body the walls are approximated, the fornix being generally distended with gas. The peristaltic waves are almost entirely absent in the erect position, and show then

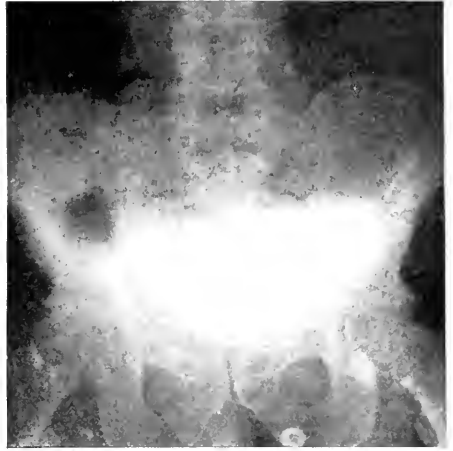
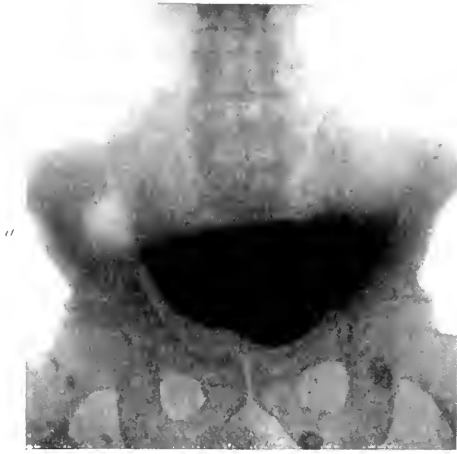

PLATE XLV. —OPAQUE MEAL IN STOMACH AND COLON.

- a*. Opaque meal in stomach twenty-four hours after ingestion ; pyloric obstruction confirmed at operation.  
*b*. Delay in stomach due to adhesions at pylorus, which was attached to anterior abdominal wall.  
*c*. Colon from the same patient, showing a sharp bend in transverse colon, which was adherent to anterior abdominal wall, confirmed by operation.





only in the pyloric canal. They are more frequent and deeper when the patient lies down. In most of these cases a condition of atony of the stomach wall supervenes. Then great dilation may follow, though the atony may be compensated for by muscular hypertrophy. In ptosis with atony the stomach is incapable of emptying itself for six to eight hours, or even longer, after ingestion of the meal.

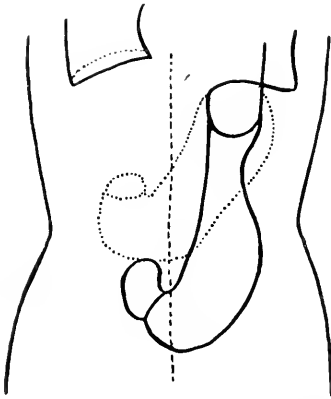

FIG. 168.—To show position of stomach in ptosis. Pylorus is also dropped. Dotted line represents the normal position.

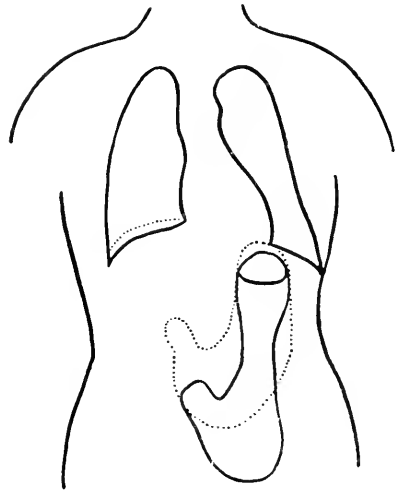

FIG. 169.—Diagrammatic representation of pyloroptosis, with some atony of the stomach.

*Pyloroptosis.*—This is a pronounced form of ptosis, involving the pylorus, which is often as low as the fifth lumbar vertebra.

*Ulcer of the Stomach.*—The diagnosis of gastric ulcer by the Röntgen method is one of its greatest advances. The extent to which the stomach wall has been involved in the pathological process influences the accuracy of the diagnosis, simple ulcer involving only the gastric mucosa being the most difficult to distinguish. Perforating ulcers that involve the muscular wall can be recognised in a much larger percentage of cases, while perforating ulcer of the callous type can be detected in the majority of cases. Chronic ulcers with or without perforation that have produced contractions, present a picture of hour-glass contraction, and are easily recognised.

Care should be taken to watch the meal entering the stomach. Hour-glass contraction can readily be recognised, and the presence of a narrow canal between the two segments is diagnostic. A large shadow in the upper segment is often clearly seen, soon a fine pencil of bismuth may be detected passing through the stricture, and later the whole of the meal may be located in the lower segment. This class of case must be differentiated from the malignant hour-glass contraction and the intermittent and pseudo hour-glass contraction. Perforating hour-glass contraction, which has not changed the form of the stomach through the contraction of scar tissue, is the most readily diagnosed ulcerative condition, except hour-glass contraction. Haudek first established their radiographic diagnosis, and has formulated their Röntgenologic symptom complex and signs as follows :

(1) *A diverticular* projection from the stomach shadow, mostly on the lesser curvature.

(2) *Movability* of the bismuth mass by palpation.

(3) *The persistence* of a bismuth shadow at a particular point.

(4) *A hemispherical* collection of gas above the bismuth shadow.

(5) The constant and marked contraction of the greater curvature of the stomach at a point opposite to the shadow, approximating in form to an hour-glass contraction.

(6) *A displacement* to the left of the pyloric portion of the stomach, especially noticeable in males, with a perpendicular outline on the right border of the greater curvature.

(7) *A retardation* of motility, so that six hours after the ingestion of the bismuth meal a large portion remains in the stomach. This residue is placed to the left of the median line when the ulcer lies high.

(8) *Antiperistalsis*.

(9) The presence of an acutely tender spot, with a sense of resistance on pressure, in the epigastrium, in the region of the left rectus muscle. This is frequently seen in ulcer of the body of the stomach.

It is of practical importance to remember that these ulcers, while occurring most frequently on the lesser curvature of the stomach, may be found on the anterior and posterior walls. During the examination, therefore, the patient must be rotated, or the tube displaced from side to side, in order to bring ulcers in these positions to the profile of the stomach shadow. Unless this is done they will be entirely hidden by the mass of bismuth in the stomach, and escape detection.

The neighbouring organs most frequently involved in perforating ulcers are the liver and spleen. When the liver is involved the shadow rises and falls with respiratory movements.

*Callous Ulcers.*—The most common seat of callous ulcers is upon the lesser curvature of the stomach, the contraction due to cicatricial changes after healing giving rise to a shortening of the lesser curvature. Haudek has pointed out that this leads to a dragging of the pylorus to the left, and has shown that a difference can be noted in the shape and position of the residue in the sinus and its relation to the bulbus duodeni. In perforating callous ulcers, and in florid ulcers with or without penetration, the residue in the sinus has a sharp, straight, almost perpendicular outline on the right side, with the shadow of the bulbus duodeni to the left of the umbilicus, and nearly above the sinus. In carcinoma of the pylorus the residue has a poorly defined jagged right border, while the bulbus duodeni is well to the right of the umbilicus. In uncompensated stenosis of the pylorus the residue is broader, is drawn out in the form of a crescent, and extends to the right and left of the middle line, while the shadow of the bulbus duodeni is far to the right.

Plate XLII. illustrates phases in the passage of the food from the stomach in pyloric stenosis.

Plate XLV.. Fig. *a* illustrates the appearance shown by the bismuth food in a large atonic stomach, with pyloric stenosis, due to the healing contraction

occurring in pyloric ulcer. Note the level upper surface of the bismuth shadow.

*Penetrating Ulcer.*—Penetrating ulcer of the stomach differs markedly from perforating ulcer, in that instead of the rounded diverticulum filled with bismuth and gas, there is only a slight bud or spur-like projection from the profile of the stomach shadow. The right lateral portion is of value in these cases. A variation in the technique is described by Schwartz, in which he employs a watery solution of bismuth in small quantity. It is used with the patient on the back. The patient is then turned gently first on one side and then on the other, and finally on the abdomen. This is to coat the mucosa, so that shallow ulcers will retain a small amount of bismuth, when the patient stands erect. He has succeeded in this manner in locating small ulcers on the posterior wall of the stomach. The simple ulcer is the most difficult to demonstrate, and is frequently missed altogether. The florid or indurated ulcer, either with or without erosion, is also very difficult to recognise,

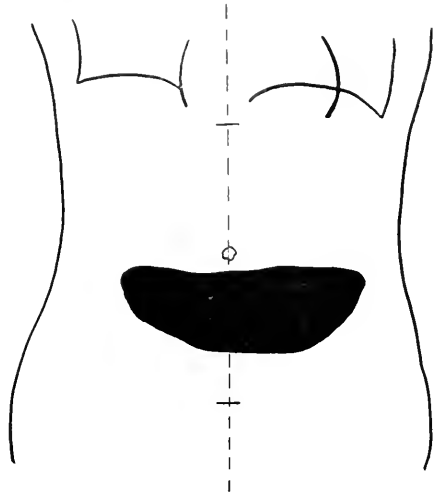

FIG. 170.—Diagram to represent a condition met with in examination of the stomach. This is typical of atony of the stomach walls secondary to pyloric obstruction.

as are also ulcers situated in the pyloric canal or in the neighbourhood. Except in rare cases of perforating ulcer, the X-ray picture is not definite. The diagnosis must be based on the obstructive signs :

(1) The spasm of the pylorus is more marked ; (2) there is a decrease of the motility, and a large residue of the bismuth meal is left in the stomach after six hours. This is the result of the intermittent opening of the pylorus in the presence of spasm.

If care is taken to examine the patient frequently at the time when the food is engaging in the pylorus, a small streak of the bismuth is occasionally seen entering and passing through the narrow canal. It may remain for an appreciable time in the stricture.

*Pseudo Contractions of the Stomach.*—These are the result apparently of various neuroses that produce a contraction of the greater curvature. A deep infolding of the greater curvature of the stomach is the result of these contractions. Atropine given hyperdermically frequently aids in clearing up the diagnosis. This type must be differentiated from the intermittent hour-glass contraction of the stomach as well as from the benign and malignant hour-glass contraction.

*Intermittent Hour-glass Contraction.*—This may simulate in every detail the true hour-glass contraction. It may take the form of a contraction in

the middle of the stomach, with apparently two equal portions ; or the upper segment may contain all the meal with the magenblase well marked above. The greater curvature shows a marked depression in other cases. There



FIG. 171.—Hour-glass stomach. Photograph from a post-mortem specimen. Shows a well-marked constriction, resulting from a healed ulcer. There were a number of small active ulcers in both segments of the stomach.

is no retardation of motility, and there may be even an increased rapidity of emptying, the administration of atropine leading to no change in the condition. Such cases require to be examined on more than one occasion before an accurate diagnosis can be made. There is never any residue after six hours. The normal stomach picture will be

obtained on one examination, and the hour-glass contraction at another time. The appearance of hour-glass contraction may be reproduced in the same patient on more than one occasion. It is possible that the condition of the colon, bound by adhesions, may be an explanation of the contraction.

*True Hour-glass Contraction.*—There are three varieties met with : (1) *Congenital* ; (2) *Non-malignant* ; (3) *Malignant*.

(1) The existence of true *congenital* hour-glass contraction is doubted by many authorities, and when it does occur it may be regarded as an anatomical curiosity.

(2) The *non-malignant* form is generally due to the existence of ulceration of the stomach wall, with resulting cicatricial changes, leading to con-

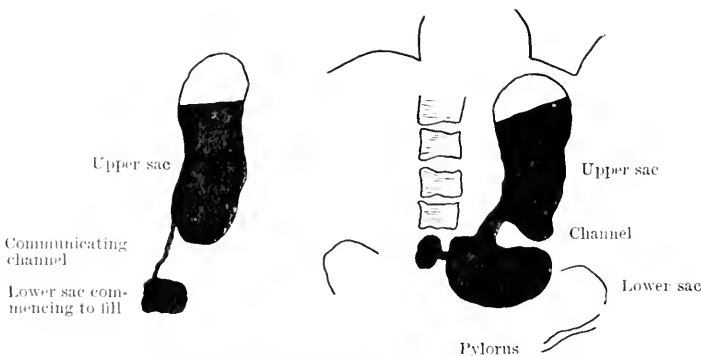

FIG. 172.—Hour-glass contraction of the stomach. (1) Soon after ingestion of food. (2) Several hours after ingestion.

traction in particular parts of the walls, ulceration generally beginning on the lesser curvature of the stomach. The frequency of hour-glass contraction is probably greater than was at one time supposed. No doubt many more

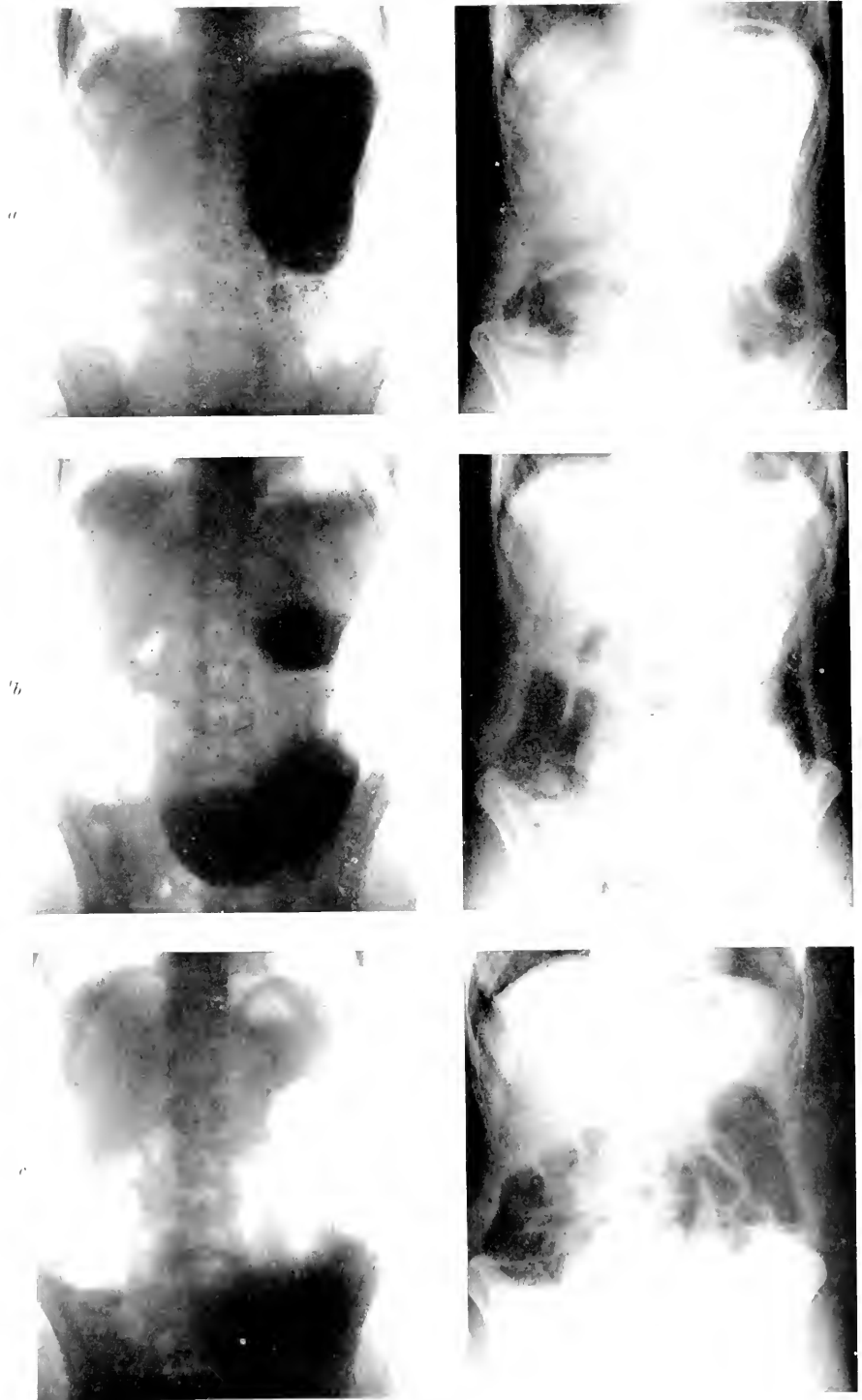

PLATE XLVI.—HOUR-GLASS CONTRACTION OF THE STOMACH.

*a*, Shortly after ingestion of barium meal. Note shape of stomach and small portion of the meal engaging in a narrow channel of communication.

*b*, Same stomach several hours later; the greater portion of the meal is now in the lower sac. Upper sac is empty, nearly all of the meal is now in the lower sac. Eight hours after ingestion very little of the food has passed through the pylorus.

*c*, Radiograph taken at ten hours, and later showed marked delay in emptying time of stomach.

Diagnosis, hour-glass contraction of stomach, also pyloric stenosis secondary to another ulcer, confirmed by operation.



cases are now recognised, as a result of improvements in the technique of examination. The entrance of food into the stomach is an important feature in diagnosis; the opaque meal collects in the upper zone of the organ, and only gradually passes through the tortuous canal into the pyloric portion. The appearance of an hour-glass stomach is quite typical, and not likely to be overlooked when once it has been seen. The emptying time is necessarily increased by the delay in passing from one portion of the stomach to the other, spasmodic contractions also in part adding to the already lengthened emptying period. Benign hour-glass contraction may also be combined with ulcerative pyloric stenosis; or several acute ulcers may be present in a stomach which has at an earlier date had an ulceration at the lesser curvature, with the subsequent formation of an hour-glass contraction. Fig. 171 shows a post-mortem stomach, which is markedly hour-glass; it had several small ulcers in both segments.

*Malignant Hour-Glass Contraction.*—The invasion and concentric spread of a growth in the circumference of the body of the stomach results in an hour-glass form of stomach, the growth spreading in all directions, upwards, downwards, and concentrically, though the growth may not be equal in all directions. The resulting Röntgen picture is, therefore, not only one of lacunar biloculation, but also of a ragged irregularity and deficiency in the stomach shadow, which may have a funnel-shaped entrance and exit. The food on entering the stomach passes directly through the canal, if it has any degree of lumen, into the lower pole of the stomach. The emptying may not be delayed, unless the pylorus is also involved. In malignant disease the normal relations are more nearly maintained, as there is not so much displacement due to cicatricial contractions. The question of a callous ulcer taking on the malignant characteristics must be referred to. In all probability the great majority of simple ulcers remain so to the end, evidence being rarely produced to show that the malignancy has been implanted on a chronic simple ulceration. The possibility of such an occurrence renders an absolute differential diagnosis impossible in all cases.

*Cancer of the Stomach.*—This is one of the most important diseases for the use of Röntgen rays in diagnosis, for in no situation is the early diagnosis of cancer so essential as when it locates itself in the stomach. Taken in conjunction with the history and the evidence of chemical examinations by means of the test meal, the Röntgen method completes the picture, and enables us to make a positive diagnosis not only of the presence of a growth, but also of its position and size, the involvement of neighbouring organs, and the possibility of an early radical operation. This point has been well demonstrated by repeated examinations of cases. Several illustrations are given to show the value of a thorough bismuth meal examination.

Carcinoma may be found in any portion of the stomach, the most common situations being the cardiac orifice, the pylorus, with the adjoining stomach wall, and the lesser curvature of the body of the stomach. The characteristic appearance is that of a stomach shadow more or less ragged and irregular in a part of its extent, with generally a delay in the passage of

the food : masses of the growth project into the bismuth food, and so cause



FIG. 173.—Three examples of carcinoma of the stomach. (Haudek.)

irregularities of the shadow. All cases examined which show irregularity should be re-examined in order to confirm the diagnosis.

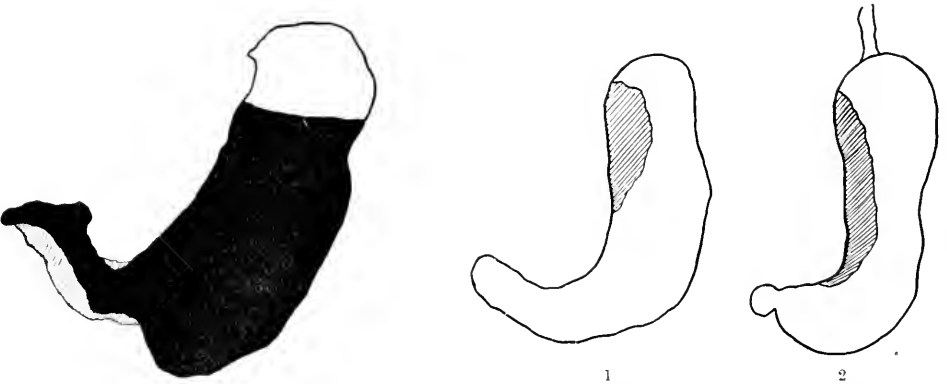

FIG. 174.—Illustrating the appearances seen in carcinoma at pyloric end of stomach. The shaded area represents the tumour.

FIG. 175.—Situations of tumour of stomach.

(1) Tumour situated near the cardiac end of the stomach. The stomach in this case contained bismuth food twenty-four hours after ingestion. There was no pyloric obstruction found at the operation.

(2) Large carcinoma involving lesser curvature. The stomach emptied rapidly in this case. A large tumour was found converting the lumen of the stomach into a funnel-shaped channel.

*Malignant disease in other organs* may press upon the stomach, and so give an erroneous impression that this organ is involved ;

in a particular instance the stomach at operation proved quite free from growth. Infiltrating malignant disease results in a thickening and hardening of the stomach walls, producing a form of stomach like the hypotonic. Peristalsis is wanting, sometimes to a marked degree, in the portion of stomach wall involved, and the whole stomach may be converted into a rigid canal of small calibre, through which the bismuth meal flows quickly into the duodenum. In carcinoma of the pylorus the defects in the stomach shadow vary in form with the extent and position of the tumour.



## Examination of the Small Intestine

Bismuth food passes so rapidly through the small intestine that the determination of a peristaltic wave is a matter of great difficulty. With the exception of a small mass in the *bulbus duodeni*, and the collection of masses in the convoluted portion of the ileum, little is seen in normal cases, but rapid radiographs show small flakes scattered throughout the duodenum, jejunum, and the upper portion of the ileum. It is very important to be able to demonstrate the duodenum in the normal condition, and in morbid conditions due to various causes.

**The Duodenum.**—The duodenum comprises the first nine or ten inches of the small intestine. It passes from the pyloric end of the stomach, at first backwards and then downwards, until it disappears behind the transverse colon. Passing to the left of the spine, it ascends for a short distance, and at the level of the second or third lumbar vertebra passes into the jejunum, forming a sharp bend forwards and downwards, which is named the duodeno-jejunal flexure. It makes a curve round the head of the pancreas. The first portion is nearly horizontal, and is free and movable like the stomach. The second or middle portion descends, and is about 3 inches in length. The third, or inferior portion, is the longest of all. After crossing from right to left of the spine it ascends to end in the jejunum, opposite the second or third lumbar vertebra.

The bismuth meal passes rapidly through the duodenum, in from 25 to 60 seconds. Special technique is necessary to show successfully the duodenum in the normal subject, departures from the normal being more easily shown. Observations on the duodenum may be made with the patient standing up or lying on the X-ray couch. It is better to examine the patient in the upright position, centering the tube over the pyloric end of the stomach. A slight degree of lateral rotation of the patient throws the duodenum well into the field of vision, and on screening, the bismuth is seen throughout its whole course along the duodenum. Jordan describes a method by which he claims to be able to demonstrate the duodenum in nearly every case. He uses a preparation of bismuth carbonate with sugar of milk, and examines the patient in the right lateral position upon the X-ray table. His special technique for the examination of the duodenum is as follows :

### METHOD OF EXAMINATION FOR INTESTINAL STASIS

The patient takes his usual breakfast. About one or two hours later he comes for his first examination.

An emulsion is prepared consisting of bismuth carbonate, 4 oz. ; sugar of milk, 1½ oz. ; water in amount sufficient to make an emulsion which is not thick.

The whole drink makes less than a tumblerful. In the case of big subjects, 5 oz., or even 6 oz., of bismuth carbonate are given, with a correspondingly greater amount of sugar of milk and water ; even this makes no more than a tumblerful. The water should not be quite cold, especially in winter. I have not had a single case in which this dose has produced the slightest untoward result.

The sugar of milk in this "standard meal" has a threefold function : (1)

to make a satisfactory emulsion, (2) to increase the bulk of the meal, and (3) to make the meal pleasant. In some cases it has a mild laxative effect.

The patient is first examined upright on a revolving saddle seat with canvas back. The chest is examined, first in the anterior view, and then in the right anterior oblique view. While in this position (R.A.O.) the patient begins to drink the bismuth emulsion, and its course down the œsophagus is well shown; if this appears normal, and the bismuth begins to enter the stomach at once, the patient is swung round to the anterior position, and the level of the great curvature of the stomach is noted as the first portions of bismuth reach it. The final level of the great curvature is lower than usual, the difference being due to the weight of the bismuth.

After the vertical examination the patient is examined on the couch—supine, supine after lying on the right side, prone. All details regarding the size, shape, and position of the stomach and duodenum may be determined at this examination, and accurate observations may be made of the motor activities of these organs. Subsequently the bismuth passes through the small and large intestines, and enables them to be studied to great advantage.—*B. M. Journ.*, Nov. 22, 1913.

**Duodenal Ulcer.**—These may vary in character from the simple to the perforating. In superficial ulcer the emptying time of the stomach is normal or decreased in contrast to the delayed emptying in cases of gastric or pyloric ulcer, which produce a spasm of the pylorus, the stomach generally having the hypertonic form. Penetrating ulcer of the duodenum is less frequent, and in addition to the symptoms of superficial ulcer has the characteristic diver-



FIG. 176.—Opaque meal in ileum and caecum, five hours after ingestion. Stomach was completely emptied. Note the contracted ileum entering caecum, dilatation behind the contraction, and stasis of food in small intestine. Figs. 176 and 177 being reproduced from positives the position of the caecum is reversed.

ticulum outside the normal shadow of the duodenum, which persists as a small bismuth residue after the duodenum is empty. The bismuth shadow is therefore more marked in duodenal ulcer, because a characteristic of all ulcers of this part is the retention of the opaque chyme for a longer period than normal, as the result of a mild stasis, due to spasm at the duodeno-jejunal junction.

**The Jejunum and Ileum.**—These may be subject to ptosis when a general viscerop-tosis is present, though this is not common. Dilatation of the ileum may be the result of an obstruction at the ileo-caecal valve or

in its vicinity, when there is a delay in the passage of food to a marked degree. Malignant or inflammatory strictures may be shown, while the ileum may



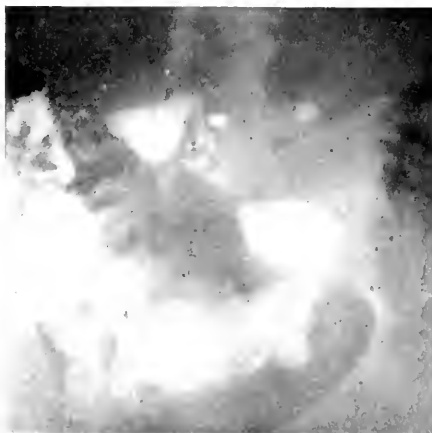
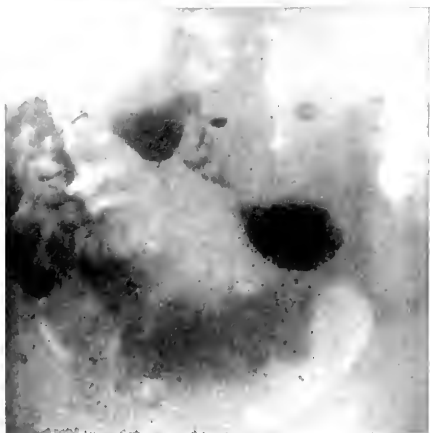
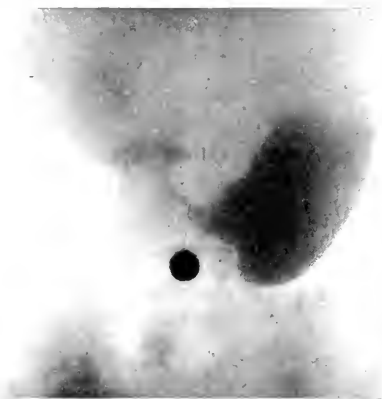

PLATE XLVII.—STOMACH SHOWING OBSTRUCTION AT PYLORUS.

- a.* Stomach showing marked delay in emptying time, due to cicatricial contraction at pylorus. Diagnosis, pyloric ulcer, confirmed at operation.
- b.* Showing prolonged delay at pylorus. Note irregular outline and narrow channel. Diagnosis, carcinoma of pylorus, operable. Confirmed at operation, tumour excised.
- c.* Marked delay in emptying of stomach, narrow channel connecting stomach and duodenum. Diagnosis, cicatricial contraction at pylorus, due to gastric ulcer, confirmed at operation.

attain to a diameter equal to that of the colon, the obstruction producing these changes being generally chronic in its nature, and the result of malignant or tubercular disease, or of adhesions or contractions due to chronic appendicitis, or other inflammations of the cæcum and colon. These kinks have been described by Sir Arbutnot Lane, and demonstrated by Dr. Jordan by means of the bismuth meal. It is worthy of note that an ileal kink can be demonstrated in one position while in another it is not shown. These kinks should always be shown with the patient in the erect position where possible. In a true kink the intestine should be distended on the proximal side of the kink, and there should be definite evidence of narrowing at the point of obstruction. Figs. 176 and 177 show a condition of ileal stasis which was definitely diagnosed by the radiographic examination. The case was sent as a doubtful condition of appendix, with a suggestion that the condition was due to the presence of gallstones; the physician in attendance suspected adhesions in the region of the appendix. The X-ray examination revealed a condition of ileal stasis, which showed definitely in examinations lasting over several hours. A positive diagnosis of obstruction due to adhesions was given. The surgeon who operated reported as follows :

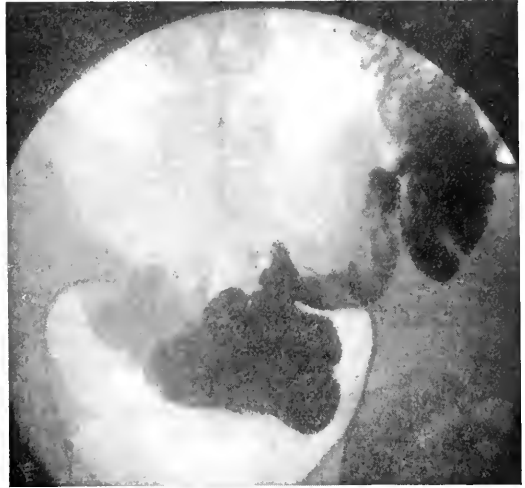

FIG. 177.—Same case at a later stage, ten hours after ingestion. The cæcum contains more of the food. The contraction is still seen at the entrance to cæcum, and there is a marked degree of dilatation and stains in small intestine.

Diagnosis : adhesions in neighbourhood of ileo-cæcal valve.

“The ileum was kinked by a fibrous band 4 to 5 inches from the ileo-cæcal valve in the position depicted by the skiagram. The gall bladder was quite free.”

## Examination of the Large Intestine

The large intestine is divided into (1) Cæcum ; (2) ascending colon ; (3) hepatic flexure ; (4) transverse colon ; (5) splenic flexure ; (6) descending colon ; (7) sigmoid flexure ; (8) rectum. The anatomical relations of these parts should be clearly understood.

The cæcum is that portion of the colon which lies below the ileo-cæcal valve. It is almost entirely surrounded by peritoneum, and, being freely movable, it may consequently vary in position in different subjects. It may

be found in the pelvis or displaced upwards. The appendix is sometimes seen filled with bismuth, and may be the seat of concretions or foreign bodies. Pus, the result of an inflammatory process, may occasionally be seen.

The ascending colon extends upwards and backwards, into the iliac fossa, and reaches nearly to the liver, where it forms a more or less acute angle.

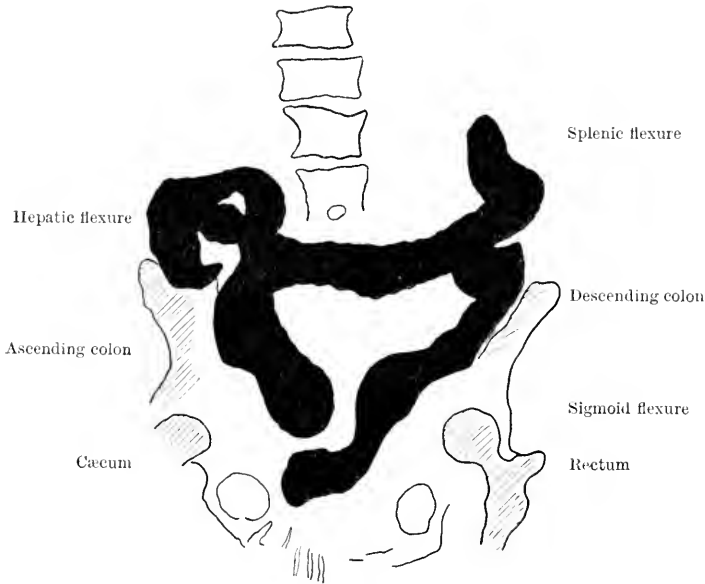

FIG. 178.—Diagrammatic representation of colon filled with bismuth food.

The hepatic flexure, together with the first portion of the transverse colon, is frequently ptosed, drawn forwards and downwards; but this condition need not necessarily give rise to symptoms.

The transverse colon extends from the hepatic flexure to the splenic flexure. It varies greatly in position, frequently forming a well-marked loop reaching down into the pelvis. The ascending and transverse colons may be entirely in juxtaposition when the latter is ptosed, adhesions sometimes binding the two together. The transverse colon forms a tense band around the greater curvature of the stomach, the *latter* third of the transverse colon rising almost perpendicularly to the splenic flexure, where it forms an acute angle with the descending colon. It is often difficult to differentiate the one from the other by the ordinary radiograph. Stereoscopic radiographs are useful when doubt exists as to the condition present.

The splenic flexure is firmly held up to the diaphragm by a strong ileocolic ligament.

The descending colon extends from the splenic flexure to the brim of the pelvis.

The sigmoid flexure is variable in shape, length, and position, as it is attached by a mesentery which varies in length.

The rectum is the most distensible portion of the colon.

*Chronic constipation* is a condition which frequently calls for radiographic examination. With some individuals it involves observation on the case for three or four days. The colon is frequently low in the pelvis, and it may be bound down by adhesions.

*Tumours of the large intestine* may cause partial or complete obstruction of the bowel. The double method of giving bismuth by the mouth and injecting the bowel from below is useful, the screen examination being useful when the latter method alone is employed, because we can watch for the point of stricture. Plates may be taken to confirm these observations.

*Intestinal Stasis.*—Jordan adds to the knowledge of intestinal stasis. He associates ileal stasis with a distended duodenum, especially in its first part, and employs a special technique to demonstrate this condition. The jejunum is found to be pulled down vertically, forming a sharp kink with the fixed end of the duodenum. He ascribes this to the direct result of gravity upon the overloaded lower ileal coils. The obstruction produced by the duodeno-jejunal kink is sometimes increased by tension of the first few inches of the jejunum.

Hertz has never observed true stasis of the duodenum, except in cases of organic obstruction, and to a less extent in extreme gastropnoia, in which a kink may occur at the point where the duodenum is fixed. He is convinced that kinking plays no part whatever in the ætiology of duodenal ulcer; nor does he believe that ileal kink is of any importance in the causation of simple constipation. He shows that all cases of constipation fall into two groups:

(1) Delay in the passage through the colon, defæcation being normal, "intestinal constipation."

(2) Dyschezia, in which the passage through the colon, is normal, but defæcation is inefficiently performed.

## Foreign Bodies in the Alimentary Canal

Patients are frequently sent for the determination and subsequent localisation of foreign bodies in the alimentary canal. As it is impossible to indicate in what positions they may be found, an examination of the entire tract is necessary, and the technique will be described in some detail. The foreign bodies most frequently met with are (1) coins, (2) metal toys, (3) pins, needles, safety-pins, (4) nails, (5) teeth and artificial plates, (6) hair-pins, (7) enteroliths and gall stones, (8) hair-balls.

The whole alimentary tract from the pharynx downwards must be examined, especially in children. For the pharynx and œsophagus the lateral position gives the best result. It is often difficult to locate the precise position of foreign bodies in the stomach. In doubtful cases a small quantity of bismuth food may be given, and the position of the foreign body in relation to the stomach shadow determined. When the foreign body has been located in the stomach, the question is raised as to whether it is likely to pass through the pylorus; the necessity, or otherwise, of operation is often decided by the radiograph, and depends to a large extent on the nature of the foreign

body and the presence of urgent symptoms. A foreign body which causes no symptoms and no irritation may lie in the stomach for weeks and ultimately be passed. The passage of sharp-edged or pointed bodies may be greatly facilitated by administering small pledgets of moistened cotton wool. The most usual spot at which to find a foreign body blocking the intestine is the ileo-cæcal valve. When a foreign body has been located in the alimentary tract the patient should be screened and radiographed at regular intervals. The body is thus kept under rigid observation, and should an operation become necessary it can be conducted with the least possible delay. Stereoscopic radiographs taken immediately prior to an operation, or the use of X-rays at the time of operation, when the fluorescent screen may be used from time to time, will be found useful as a guide to the surgeon. By the former method the object may be located with fair accuracy; by the latter method the operator may be able to guide his instruments to the foreign body. Work of this special character requires to be carried out in the dark under aseptic conditions. The top of the couch must be made aseptic and the fluorescent screen one that can be sterilised.



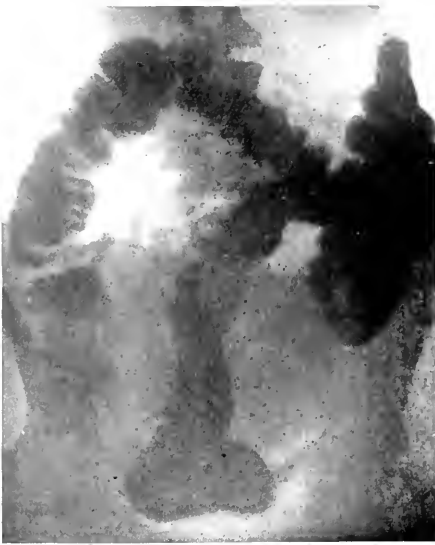

PLATE XLVIII.—OPAQUE ENEMA IN COLON.

*a*, Bismuth enema, showing rectum, pelvic colon, sigmoid flexure, splenic flexure, transverse colon, hepatic flexure, and caecum. *b*, Same after partial evacuation. The two plates *a* and *b* were taken in the horizontal position; when the patient assumed the vertical position the transverse colon formed a distinct loop with the convexity towards the pelvis. *c*, Marked delay in descending colon. From a case of obstruction of the colon on left side. At operation the colon was found to be stretched over an enlarged kidney, which contained fluid.



## THE X-RAY EXAMINATION OF THE URINARY TRACT

Radiography has now attained to an important position in the examination of the urinary tract. From a diagnostic point of view the information it gives is of the highest importance. Every case of suspected disease should be thoroughly examined before surgical interference is decided upon. In cases of suspected urinary calculus it is of great service in determining (1) the presence of a stone ; (2) its position and size ; and (3) the prognosis and treatment of the particular case, which are largely determined by a correct interpretation of the radiographic examination. It is, however, not only in cases of calculi that the use of radiography is helpful. Tuberculous disease of the kidney, ureter, and bladder may be demonstrated, and in other diseases of the urinary tract the use of X-rays may be helpful. Tumour of the kidney and bladder can be shown ; cystic disease of the kidney is sometimes demonstrable ; while it may be possible to show chronic cystitis when phosphatic deposits occur in the bladder. Hypertrophy of the bladder and other conditions present themselves for consideration, when an exhaustive examination of the organ is required.

### Technique

A thorough examination of the urinary tract should be undertaken in all cases that come up for diagnosis. If stone in the kidney is suspected, it is not sufficient to examine the suspected kidney alone ; the whole tract should be systematically gone over. There are several points which are of the greatest importance in carrying out a thorough examination of the regions suspected.

*A. The preparation of the patient* is the first item for consideration. In all cases the patient should be prepared in the same manner as when an operation is contemplated. The bowels should be thoroughly cleared the evening before the examination, and a large enema should be administered just before the patient comes to the X-ray room. The selection of a purgative is of importance. Where possible, a vegetable purgative should be employed in preference to a chemical one, as the latter may cause shadows in the bowels, superimposed over the various parts of the urinary tract. This may not appear to be of any importance, but we have to bear in mind that the cause of the trouble may be a very small calculus in the ureter, and if it is to be shown, it is of the greatest importance that there should

not be any conflicting evidence in the nature of shadows cast by small crystalline bodies in the intestines.

*B. Examination of the Patient.*—There is considerable latitude in the choice of a position for the examination of a patient suspected of having a stone in the urinary tract. It will be well to describe the commoner methods of examination, and then leave it to the operator to use the one he is best acquainted with.

Screen examination of the patient should always be done as a matter of routine. If the patient is placed face downwards on a couch with the tube underneath, it is possible to examine thoroughly the whole region. The fluorescent screen is placed on the patient's back, and by moving the tube about underneath the table, both kidneys, ureters, and bladder may be carefully examined. By this method of examination the majority of stones may be seen, also the size and position of the kidneys, the motility of the organs during respiration, and the size and position of the bladder. In some cases it may be useful to distend the bladder with sterile water before commencing the examination. In cases of suspected ureteric stone, an opaque catheter may be placed in the ureter from the bladder, and a stone may be located by this method. Before removing the patient it is well to take a series of plates in the position in which the screen examination has been conducted. This is useful as a permanent record of the screen examination. In particular cases a tracing may be made of the exact appearance of the parts under examination. In these circumstances a large plate may be employed. Should it be desirable to radiograph particular areas in this position, the tube is centred under the particular part, the diaphragm is closed down to a suitable aperture, a plate is placed on the back, pressure applied, and the exposure made.

With a rapid exposure movement of the organs due to respiration need not interfere with the result, but when longer exposure is necessary some form of compressor must be employed, such as a large air cushion under the patient, and pressure from above on the plate sufficient to steady the parts, in order to get a good radiograph.

The second method employed for the examination is to place the patient on his back; the plate is placed under the region required, and the tube is operated from above. In this method the screen examination is not possible, and therefore we have to depend entirely upon the examination of negatives so obtained. Here it is necessary to examine the whole tract in sections. The employment of some form of compressor is of value in this method. Any compressor which steadies the parts and arrests respiratory movements is sufficient for the purpose. The table may either be used with the tube below the patient for screening and for the taking of radiographs, with a compressor upon the plate over the part to be examined; or by turning the patient on the back, the plate can be placed underneath, and the tube-holder with a large extension tube brought down on to the abdomen. A thick pad of cotton wool may be used to compress still further the abdominal contents, this also serving the further purpose of minimising the inconvenience of great pressure. Many elaborate forms of apparatus have been designed;

the best is that introduced by Dr. Albers Schoenberg of Hamburg. Figs. 179 and 180 show the essential parts of the apparatus, and its use in practice.

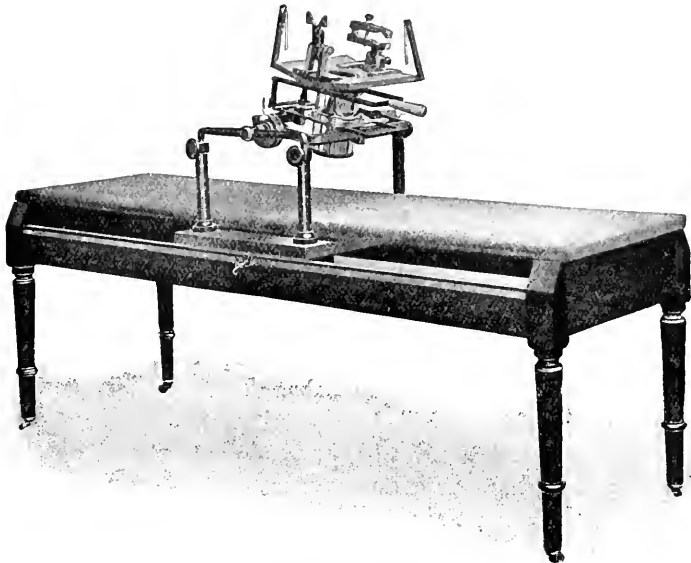

FIG. 179.—Couch fitted with kidney compressor.

It is possible by this method to get small accurate pictures of the kidneys, bladder, and ureters. A later improvement of this compressor is the

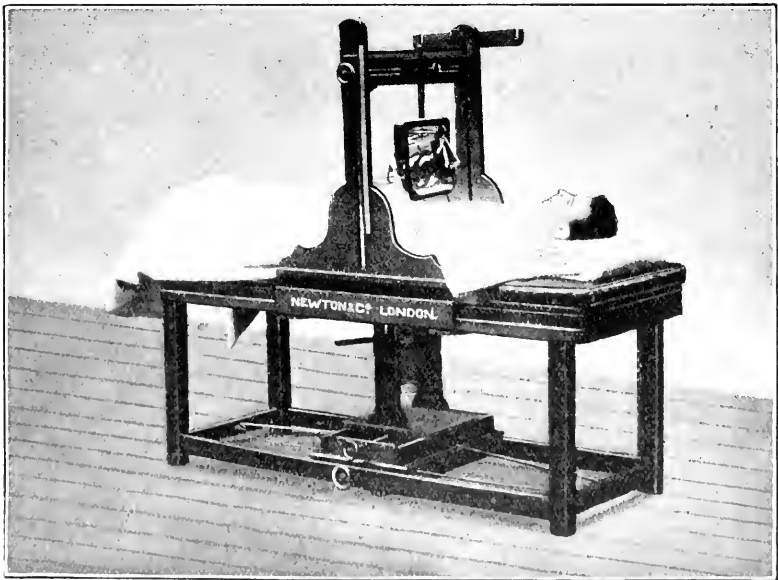

FIG. 180.—X-Ray couch to illustrate method of compression.

addition of a stereoscopic movement to the apparatus, thus enabling stereoscopic pictures of the urinary tract to be taken.

In all cases it is important so to compress the parts that a good radiograph is obtained with long or short exposures. The shorter the exposure the better is the result. Where possible, the patient should be instructed to hold his breath during the exposure. When this does not exceed 20 or 30 seconds, it is possible with a little practice for the patient to hold his breath. In this way two pictures may be obtained, (1) at the end of inspiration, and (2) at the end of expiration. When the compression is perfect, it is possible to get good radiographs with exposures of one or two minutes.

The next important point in the taking of good radiographs lies in the management of the X-ray tube. Here, again, a great deal depends upon the operator and his knowledge of the apparatus at his command. Good pictures can be obtained with almost any ordinary apparatus. It is not necessary to have elaborate installations in order to get good results. Many of our radiographs have been obtained by the use of a 10-inch coil, a mercury interrupter, and an ordinary X-ray tube. The exposure necessary may vary from an instantaneous flash to five minutes. With a 12-inch coil, a moto-magnetic interrupter, and a heavy anode Müller tube it is possible to get all the necessary detail with an exposure of about ten seconds or less.

The controlling factors are : (1) the amount of current passing through the X-ray tube, (2) the distance of the tube from the plate, and (3) the body weight of the patient. The latter factor is important because the larger the subject the further away from the plate is the tube likely to be.

It cannot be too strongly insisted upon that the controlling factor in all radiographic exposures is the X-ray tube : given a good tube, working at its proper spark-gap and allowing an adequate amount of current to pass through it, one cannot fail to get accurate results. When an imperfect tube is used, no apparatus will give the proper degree of penetration.

When a considerable amount of work has to be got through, it is well to have a number of tubes in working order. If possible, the same type of tube should always be employed, and they should be kept at as nearly as possible the same degree of vacuum. It is possible to keep a tube in good working order by never allowing it to run too long. A good tube will keep in working order for months, if it is carefully looked after. A record of all exposures, time, quantity of current used, and results obtained will be helpful in practice, for then one gets to know exactly what a tube is capable of doing. Prolonged screen examinations are harmful to any tube. Where possible, a special tube should be employed for all such work. In practice, good kidney radiographs have been obtained with all varieties of tubes.

The development of the plate deserves some notice. The radiographer requires to have a special knowledge of this section of his work. Where possible, in all important cases the radiographer should develop the plate himself. In hospital practice this is not possible, but there one generally has a nurse or photographer who looks after the development. In any case it is of importance that the person who develops the plate should have some knowledge of the conditions under which the radiograph has been taken. The developer is usually one containing metol and hydroquinone, though

in some cases pyro-soda may be employed. In a properly exposed plate, the development is generally completed in about five to ten minutes.

The plate is fixed in the ordinary way. It should be allowed to fix out in the dark or in a ruby light, though the negative is frequently examined by electric light before it is thoroughly fixed.

We have not seen any harmful results from this premature examination, but nothing is to be gained by a hasty examination, and it is evident that harm may result, so a good rule is never to examine a plate until it has been allowed to fix out thoroughly.

## Anatomical Relations of the Urinary Organs

The kidneys are a pair of bean-shaped organs, each measuring about  $4\frac{1}{2}$  inches in length,  $2\frac{1}{2}$  inches in breadth, and  $1\frac{1}{4}$  inches in thickness, and each weighing about  $4\frac{1}{2}$  ounces. They lie in the hypochondriac, epigastric, and umbilical regions, and are placed behind the peritoneum in a kind of lymph space in the fat-bearing subperitoneal tissue, opposite the last dorsal and three upper lumbar vertebræ, the right usually lying about half an inch lower than the left. The long axis of each is directed downwards and outwards. Its antero-external or visceral surface is directed outwards and forwards, its postero-internal or parietal surface looking backwards and inwards. Its outer border representing the angle of junction of its two surfaces is narrow and convex; its inner border, looking obliquely inwards, forwards, and a little downwards, is convex above and below, but slightly concave in its middle third, and fissured by the hilum. The upper extremity is rounded and supports the suprarenal body, which encroaches also upon its anterior surface and internal border. The lower extremity, also rounded, lies further from the median

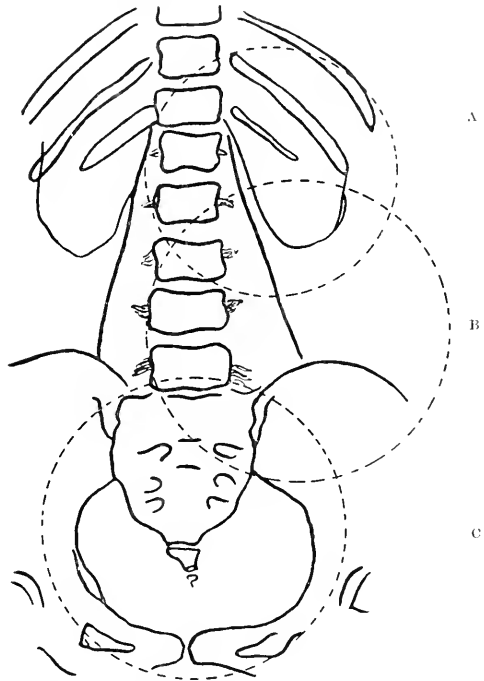

FIG. 181.—Diagram to illustrate the "areas" to be examined in radiography of the urinary tract.

Three exposures are necessary when using the compressor. A, kidney, B, ureter, C, pelvis. Note that each area should overlap the one above it if the whole tract is to be examined. The same procedure has to be followed for the other side. By using a larger extension tube the whole tract may be examined with three exposures, but in that case the tube must be centred over the middle line instead of to either side.

The dotted circles represent the area covered by the extension tube in positions A, B, and C. In region marked A the compressor is tilted upwards, in B the direction is at right angles to the plate, and in C the compressor is tilted downwards towards the feet of the patient.

plane than the upper. The hilum is a slit-like aperture in the middle of the inner border of the kidney, bounded in front and behind by two prominent lips. It forms the entrance into a deep depression or cavity, the sinus, at the bottom of which are (1) the renal papillæ, perforated by the openings of the secreting tubules; (2) the apertures transmitting the vessels and nerves to the organ; and (3) the attachments of the "calices" of the main duct, each embracing one or two of the papillæ. The kidney may, in fact, be regarded as a hollow organ.

*Relations.*—In front of the right kidney are the right lobe of the liver, the second stage of the duodenum, the hepatic flexure of the colon, a branch of the colica dextra artery, and more or less of the parietal peritoneum, on the inner side of the latter. In front of the left kidney are the stomach (with the peritoneum of the lesser sac), the splenic artery, the pancreas and the splenic vein, the splenic flexure of the colon, the parietal peritoneum, a branch of the colica sinistra artery, and the spleen (at the outer border). Behind both kidneys are the diaphragm, the psoas and the anterior lamella of the transversalis tendon (covering the quadratus lumborum), with the respective fasciæ of those muscles and the last dorsal, the ilio-hypogastric and the ilio-inguinal nerves. The diaphragmatic area is generally larger on the right side, and may be considerably increased on either, when the external arcuate ligament passes to the second lumbar process instead of the first.

The ureters are about a foot long, and lie in a sheath of subperitoneal tissue over the psoas muscles, passing behind the spermatic vessels, and after crossing the common or external iliac artery, disappear into the pelvis, where they can be traced to the bladder. The right ureter runs behind the second stage of the duodenum, and lies close to the inferior vena cava. In the female, both ureters approach the sides of the cervix uteri, and lie in contact with the upper part of the vagina, crossing it obliquely to reach the base of the bladder. The proximal extremity of each ureter begins with eight or nine short tubes called calices, which surround the renal papillæ at the bottom of the sinus. These join each other, with or without the intervention of short passages called infundibula, to form usually two tubes, the upper and lower pelvis, and the union of the two pelvis constitutes the common pelvis renales, which generally narrows to the size of a goose quill, and becomes the ureter proper. The ureters pierce the bladder at the junction of the posterior or lateral walls, about an inch and a half above the base of the prostate. The left ureter is contained in the root of the posterior false ligament of the bladder (or in part of the broad ligament in the female), and can be traced beneath the peritoneum to its entrance into the fundus of the bladder.

## Diseases of Urinary Tract

In order to make a diagnosis from negatives of the urinary tract in disease, it is necessary for the radiographer to be familiar with the appearance of good normal negatives from the region of the kidneys, ureters, and bladder.





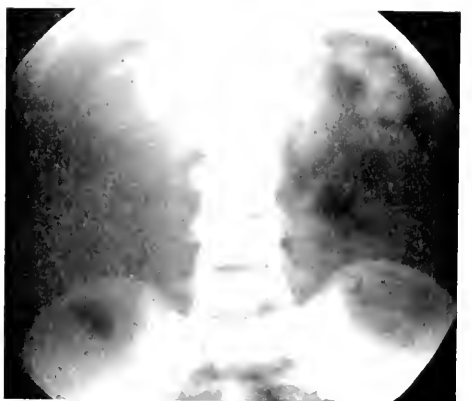
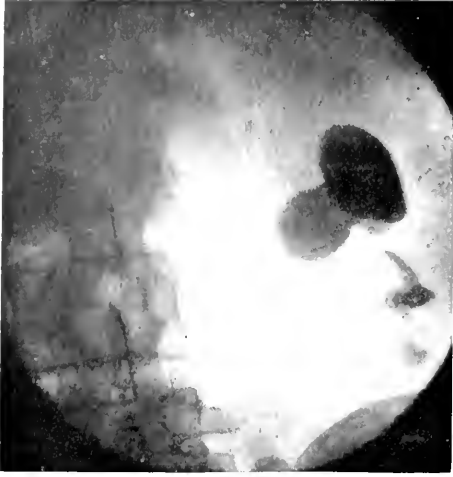

PLATE XLIX.—URINARY CALCULI.

- a.* Calculi in kidney.
- b.* Calculi in kidney. (Radiograph by C. Thurston Holland.)
- c.* Focal mass in kidney area simulating calculus.

This knowledge can only be acquired by regular practice, though it is possible to demonstrate the essential points by means of a series of radiographs. A good radiograph of the kidney area should show the outline of the organ, and should cover the whole of the kidney. In order to get the whole of the area, it is necessary to get the two lower ribs in the picture.

Bearing in mind the normal appearances of the urinary tract, we now proceed to a consideration of the abnormalities which may be met with in the investigation of diseases of the urinary organs. Before considering those diseases in order, it is necessary to consider some of the conditions which, when met with, are apt to mislead the observer and cause errors of diagnosis. Those are numerous and ever increasing in number as fresh cases are recorded.

(1) Fæcal matter in the intestines. This is a common cause of mistake in diagnosis, but if the necessary preparatory measures recommended are carefully carried out this cause should never occur.

Plate XLIX., Fig. *c*, illustrates an instance of this kind, where a large shadow is seen in the pelvis of the kidney, which might easily have been diagnosed as a large stone. A second radiograph, taken two days later after free purgation, shows the mass lower down in the colon. The point which led to a diagnosis of fæcal matter was the loaded condition of the colon over the opposite kidney region.

(2) Foreign bodies in the intestine may be mistaken for calculus.

(3) Enlarged and calcified mesenteric glands are another element leading to error in urinary diagnosis.

(4) The case of foreign bodies in the kidneys, introduced at the time of a previous operation, must not be overlooked.

(5) Concretions in the appendix have been mistaken for ureteral calculi.

(6) Phleboliths are another common cause of mistaken diagnosis. These are found low down in the pelvis, and may be mistaken for stones in the ureter.

**Urinary Calculi.—1. In the Kidney.**—Stones may be found in any part of the kidney. The most frequent position is in the pelvis or calices.



FIG. 182.—Kidney area, showing stone in right kidney. (*a*) inner edge of kidney; (*b*) stone; (*c*) edge of psoas muscle. The tube has been centred over the middle line. Both kidney areas are in the picture.

They vary in size and composition. The commoner stones are the oxalates and the uric-acid and phosphatic varieties, the uric-acid calculi being the most frequently met with. A rarer variety is composed of cystin. The great majority of kidney stones, however, are of mixed composition. It is very rare to get a pure uric-acid calculus. The shadows thrown by stones vary in density, the oxalic variety giving the densest shadow, the phosphatic next, and lastly the uric-acid variety. Stones may vary in shape. Large stones have been found to occlude the pelvis, and to have branched ramifications, filling up the calices. Small calculi may be found in the substance of the kidney, and vary in size from minute bodies to the size of a hazel nut. When many calculi are present they are usually faceted.

**Urinary Calculi.—2. In the Ureter.**—A small stone will find its way down the ureter into the bladder. The passage of a stone is usually accom-



FIG. 183.—Stone in ureter.

(By kind permission of Mr. Collinson. Radiograph by Dr. Rowden.) The calculi shown in the radiograph are remarkable. The notes of the case are here given.

A section of the lower calculus shows that its apex is formed by a small renal calculus, and that the remainder of the calculus has been formed by the deposit of successive layers of phosphates.

panied by symptoms, the chief of which is renal colic. This may be severe in character, and does not bear an exact relationship to the size of the stone. A small irregular stone may give rise to very severe renal colic; a larger smooth stone may pass more readily down the ureter, and not give rise to marked symptoms. The stone in its passage down the ureter may be

Patient aged 27 years. At age of 4 an attack of acute pain in the left renal region followed by hæmaturia. Many similar attacks followed, but were not always accompanied by hæmaturia. At age of 12 a skiagram was taken and calculus in the left kidney was diagnosed but no operation advised. Between that time and the date I saw her attacks of pain had recurred with considerable frequency, and after leaving school she followed no occupation till the age of 22, when she became a barmaid. Had often to return home on account of pain. During 1910 several severe attacks of hæmaturia.

*On Examination.*—Left kidney not palpable; in the region of the left ureter a long, hard, sausage-shaped tumour can be felt extending from the lower pole of the kidney to the pelvic brim; per rectum a similar mass can be felt in the region of the termination of the left ureter. Its lower extremity is pointed and can be moved slightly from side to side.

Skiagram showed no shadow in left kidney; in region of left ureter a continuous shadow extending from the pelvis of the kidney to the brim of the true pelvis, and below this a second shadow extending to the entrance of the ureter into the vesical wall. The calculi appear to be articulated with one another at the pelvic brim.

*Cystoscopic Examination.*—Twenty minutes after injection of indigo carmine. Right ureteral orifice normal and excreting jets of blue urine vigorously. Left orifice situated on a mound-like elevation. No blue urine issuing, but an occasional feeble jet of blood-stained fluid. Ureteral catheter enters orifice easily, but is arrested at a point  $\frac{1}{2}$  inch from the opening.

*Operation, 17th March 1911.*—Kidney exposed and found to be hydronephrotic. No calculi in kidney. Ureter much dilated and containing a calculous cast which extended from renal pelvis to below the brim of true pelvis. Below this a second calculus articulating with the first and reaching as far as lower end of ureter. The lower calculus was removed with some difficulty owing to the upper end hitching below the pelvic brim. Ureter considerably torn owing to its friability, nephrectomy and ureterectomy. Recovery uneventful.



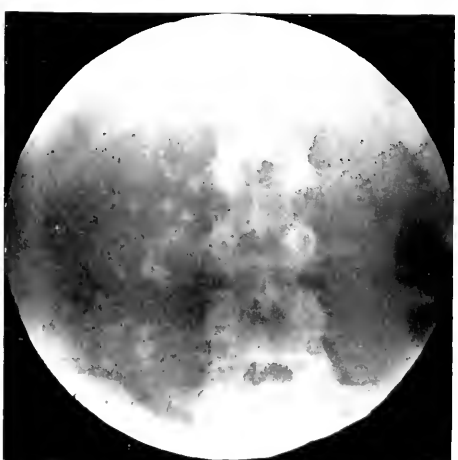

PLATE I.—TUBERCULOSIS OF KIDNEY AND MESENTERIC GLANDS.

- a.* Calcareous, caseous mass in kidney region, the result of tuberculosis, confirmed at operation.  
*b.* Calcareous patches in left kidney area, probably due to healed tubercle of the kidney; the larger shadow might easily be a calculus.  
*c.* Calcified mesenteric glands. The appearance of these shadows might lead to a mistaken diagnosis of stones in the kidney.

arrested at any part of its course, the commonest seat of arrest being in the pelvis, close to the entrance to the bladder. The symptoms may be marked according to the degree of occlusion caused by the stone. A stone which completely blocks the ureter leads to an accumulation of urine in the portion of ureter above the seat of occlusion and in the kidney. When the occlusion is not complete, the passage of urine is not completely arrested, and the more distressing symptoms may be absent. It is interesting to note that a stone may remain in the ureter for many months, and only occasionally give rise to symptoms of pain, hæmaturia, etc. An examination of the urine for pus and epithelial cells may help to determine the presence of a stone in the ureter. In several cases we have watched the passage of a small ureteric calculus down the ureter, and in one instance repeated examinations showed that the stone was slowly travelling down to the bladder; the symptoms were not severe, attacks of colic at intervals of months indicating the progress of the stone. Ultimately it was passed into the bladder and voided in the urine. This is by no means an uncommon occurrence, and should be kept well in mind when we have to consider the question of operative interference in a case where the presence of a stone has been demonstrated in the course of the ureter. If the symptoms are not acute, all small ureteric calculi should be given every facility to pass into the bladder before a serious operation is contemplated.

What might be termed a migratory stone in the ureter is well illustrated by a case occurring in the practice of Dr. Thurston Holland of Liverpool, where a large stone was found to occupy a position in the lower ureter and pelvis of the kidney alternately. At the operation it was found that the ureter was dilated to an enormous extent.



FIG. 184.—Large stone in the bladder.  
The variations in the density of the stone are well shown.

**Urinary Calculi.—3. In the Bladder.**—A vesical calculus may be formed of almost any of the urinary deposits met with, and each has its own characteristics.

(a) The uric-acid calculus is usually oval in shape and flattened, and of

variable density. On section it is distinctly laminated with a smooth or slightly undular surface of a brownish colour. It may be crusted with phosphatic material. A pure uric-acid calculus gives a faint shadow radiographically.

(b) The urate of ammonium calculus is of a similar structure, but of lighter colour.

(c) Oxalate of lime calculus is a rough irregular body, not infrequently tuberculated or even spiculated. It is extremely hard and dense, of a reddish-brown colour, or sometimes black, owing to admixture with blood. It is rarely of great size, on account of the irritation caused by its presence and its slowness of growth.

(d) A pure phosphatic calculus is somewhat rare, but any stone or foreign body is certain to become coated with a phosphatic deposit when chronic cystitis has resulted in alkaline decomposition of the urine.

(e) Cystin forms the base of a rare calculus.

(f) Xanthine or xanthic oxide is occasionally met with, but is very rare. The presence of a calculus in the bladder is readily shown by X-ray examination. Such an examination is most helpful to the surgeon, for it demonstrates the presence of stone or stones, the number of the calculi present, and to some extent the position.

In all cases of urinary calculi several examinations should be made, unless very definite evidence is obtained on the first occasion. No opinion negative or positive should be given without at least one confirmatory examination, and where an operation is contemplated a final radiograph should be taken immediately prior to the operation. In some cases, indeed, this should be done even while the patient is under the anæsthetic. In important cases this may be done and the plate developed; the surgeon will then have a very definite guide for reference during the actual operation.

**Tuberculous Disease of the Kidney** is of comparatively frequent occurrence, and is one of the first conditions to be suspected when radiographic examination has failed to show the presence of a stone. It may occur in one of three forms:—(a) *Acute general tuberculosis*, when miliary tubercles are found studding the organs. Radiography is rarely of much service in this variety. (b) *Ascending tuberculosis* may arise from a similar affection of the bladder. The mucous membrane of the ureter becomes thickened and the pelvis and calices also become affected. On clinical examination enlargement of the kidney is the next manifestation. Radiography may be helpful in demonstrating the enlarged kidneys; and when caseous matter is present or abscesses form, the negative may show these affections. (c) *Primary tuberculosis* of the kidney is generally unilateral, and commences as a deposit of tubercle in the cortex or at the base of one of the pyramids; a caseous mass forms, which may extend widely, causing disintegration of the kidney substance.

**Enlarged Movable Kidney.**—This may be (a) simple, or (b) complicated by calculi. The kidney may be found to be freely movable, and may be palpable. Screen examination will reveal its position and the amount of



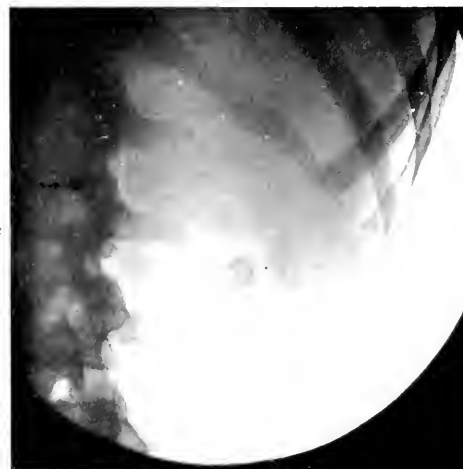
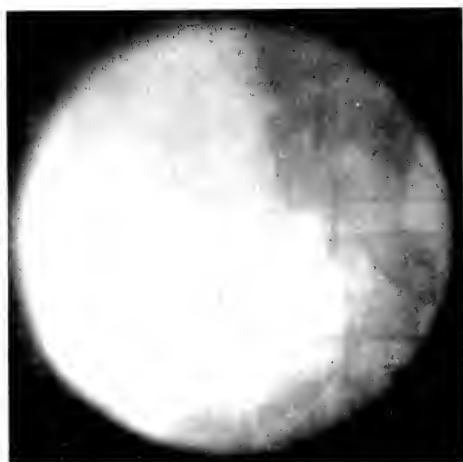
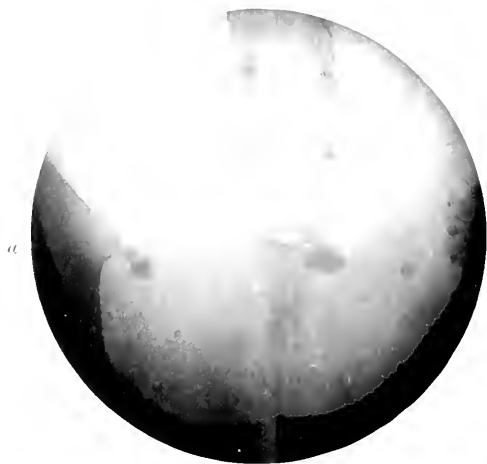

PLATE LI.—URINARY CALCULI AND GALLSTONES.

*a*, Small calculus in bladder. Phleboliths on right and left sides of pelvis.

*b*, Gallstones in gall bladder. Plate on anterior aspect of abdomen.

*c*, Two gallstones; note position below the kidney shadow. Radiograph by C. Thurston Holland.

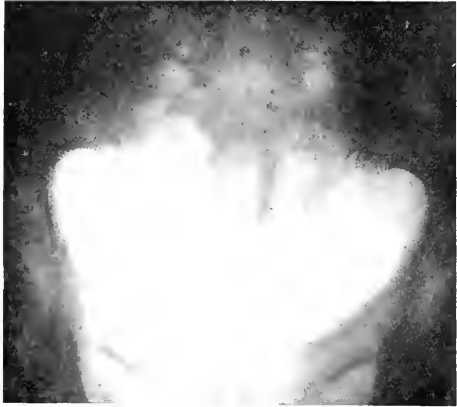

PLATE III.—KIDNEYS, URETER, AND BLADDER.

- a*, Collargol in pelvis of kidney and ureter. — Radiograph by C. Thurston Holland.  
*b*, Calculus in ureter.  
*c*, Barium injection of bladder to show diverticulum, opaque bougie in ureter.

mobility. A stone, if present, is readily demonstrable. The following illustrates a case of this kind: A lady about thirty-five years of age complained of a constant pain in the right side. Examination revealed a freely movable kidney on the right side, the lower pole being very tender and hard. Radiographic examination showed the enlarged organ displaced downwards. Two definite shadows in the cortex indicated the presence of two small stones. A large irregular shadow in the lower pole led to some discussion as to its nature. It was evidently in the kidney or attached to it, because it moved with the kidney. A diagnosis of stones in the kidney was made. At the operation two small calculi were removed. The appendix was found to be distended, and in all probability this may have accounted for the larger shadow. The patient has not been examined since the operation, but it will be interesting to note the appearance of the parts when an opportunity occurs. Thickened capsule of the kidney may give shadows suggestive of stone, especially when the pelvis is thickened.

**Tumours of the Kidney.**—These are numerous and worthy of notice, the tumour being either simple or malignant. The general characteristics are as follows: A swelling is noticed in the loin, shaped more or less like the kidney, a notch being occasionally felt on the inner border, and the outer margin being rounded. The flank is dull on percussion, the passage of the colon in front of the kidney occasionally giving a note of resonance over its anterior surface. The mass moves slightly on respiration.

*Simple Tumours.*—Cystic disease, which may be congenital or acquired, is the usual form of simple tumour. It is not infrequently bilateral when congenital. Especially when congenital, the kidney is enlarged and occupied by cysts of various size, but rarely exceeding that of a cherry. They are lined with epithelium, which is generally flattened, and filled with a limpid fluid containing urea and perhaps cholesterine. The pelvis remains unaffected until the later stages of the disease. Generally the whole kidney is affected, and may attain enormous dimensions. But occasionally the growth is limited to one part of the organ. The early symptoms are simply those of pressure, but at a later stage the secretion of urine is interfered with to such an extent as to produce uræmia. The radiographic examination of this condition is unsatisfactory. In the majority of cases the enlargement of the organ may be shown, and occasionally variations in the density of the kidney shadow may lead one to suggest the presence of fluid in the organ. One generally excludes the presence of stone in such cases, and when the symptoms are not such as to suggest acute hydronephrosis or tuberculosis then the presence of fluid showing in the radiograph may enable one to give a diagnosis of cystic kidney. We have examined a number of cases of enlarged kidney with no active symptoms, and in several a diagnosis of cystic disease of the kidney has been arrived at, and confirmed on operation. One case under observation at the present time in an adult shows shadows of considerable size in both loins. The patient has had active hæmaturia, presumably the result of traumatism.

*Malignant Disease* of the kidney may be divided into :

(1) The sarcomata of infants, which is often congenital, but may be acquired within the first few years of life. They grow to a great size, and may affect both organs. Pain and hæmaturia are absent.

(2) The sarcomata of adults occur most commonly between the thirtieth and fiftieth years of life, and are of the spindle-celled variety.

(3) Carcinoma of the kidney is an uncommon form of tumour. It is frequently associated with the presence of a varicocele, the results of pressure from carcinomatous glands.

(4) Hypernephroma arising from suprarenal tissue is not uncommon.

*Various Cystic Conditions* of the kidney may be noted in addition to the general cystic disease already mentioned :

(a) Hydatid disease affects the kidney, as any other organ of the body.

(b) Dermoid cysts have also been found.

(c) Serous cysts are occasionally met with.

One point is worthy of note in connection with the systematic examination of the kidneys. The attention directed to the suspected kidney should not lead the observer to ignore the other and presumably sound organ. When it is definitely settled that one organ is diseased and an operation is decided upon, the radiographer should proceed to demonstrate the presence of the other organ and should satisfy himself that its condition is normal. It occasionally happens that a patient comes up for examination who has been operated upon before. The presence of a scar in the loin suggests an operation, but the majority of patients have no actual knowledge of what has been done. The radiographer has then to demonstrate the presence or absence of the kidney on the side which has been operated upon. If he finds the kidney has been removed, then he proceeds to examine the other kidney. Should the patient have symptoms of disease on this side, the knowledge that one kidney has been already removed will be of great service to the surgeon.

**Occlusion of the Ureter.**—The ureter may be occluded as a result of cicatricial changes in its walls following laceration from the passage of a calculus. A simple stricture of the ureter may result. A calculus may completely block the ureter, and lead to acute symptoms of obstruction.

The ureter may be obstructed by pressure in any part of its course ; tumours of neighbouring organs occasionally lead to an obstruction. Tumours in the pelvis may gradually occlude both ureters and lead to suppression of urine. All these conditions may be met with in the examination of the urinary tract, and should be well borne in mind. A negative diagnosis of stone may be made, and in some cases the cause of the obstruction may be determined by a careful examination.

In doubtful cases of kidney disease there are other methods of examination which may be regarded as supplementary to the methods described. The examination may be rendered more valuable and absolutely diagnostic in suspected stone in the ureters, or when shadows are shown in the line of the ureters, by the passage of opaque bougies into the bladder and ureter. A radiograph taken should show the bougie in the canal, and the relationship of the shadows to it. A second method in doubtful cases is to inject into

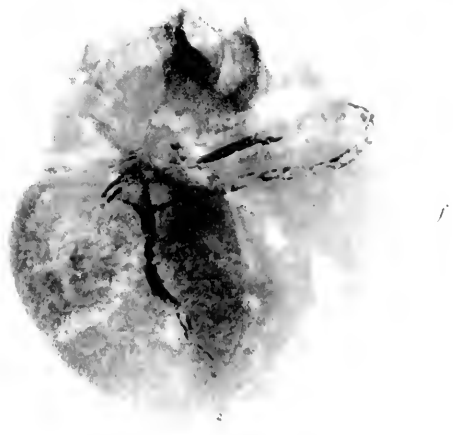
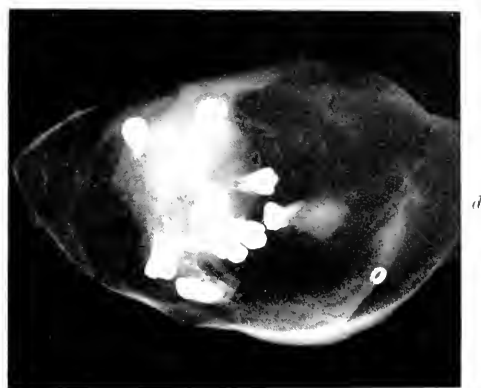
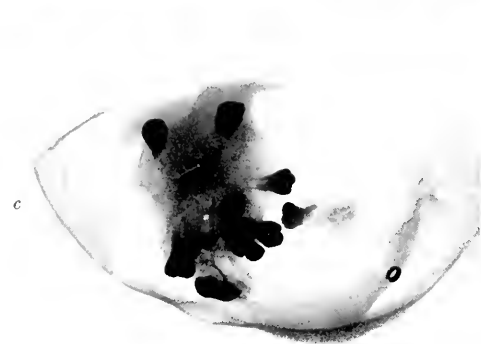
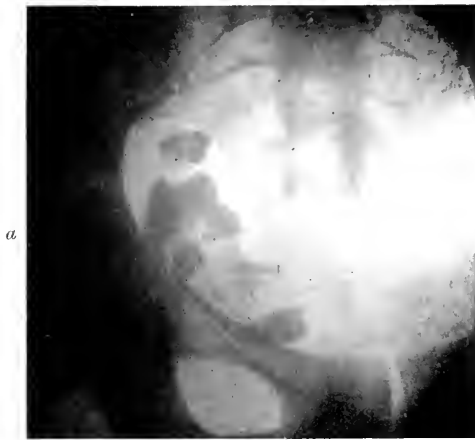

PLATE LIII.—DERMOID CYST IN PELVIS.

*a* and *b*, Radiograph of pelvis showing cyst.  
*c* and *d*, Radiograph of cyst after removal by operation. Note the teeth in the cyst.  
*e*, Photograph of cyst after removal.  
*f*, Radiograph of a heart showing atheroma of coronary arteries.



the ureter and pelvis of the kidney a solution of collargol, it being possible to demonstrate dilatation of the ureter and calices of the kidney by this method. The existence of hydronephrosis of the kidney is rendered visible when the kidney has been injected, while kinks and contractions of the ureter may also be shown by this method.

## Technique of the Examination of the Urinary System with Collargol Solution

**Position of the Patient.**—The recumbent position is the best, the patient lying on a hard couch ; anæsthetics are not employed as a rule.

**Demonstration of the Ureter.**—There are several ways in which the ureter can be demonstrated :

- (1) By the use of a silver stylet enclosed in an ordinary catheter.
- (2) By the use of catheters or bougies impregnated with bismuth.
- (3) By the use of specially prepared ureteral bougies.
- (4) By the use of collargol solution.

Nos. (3) and (4) are those usually employed, and of these two the collargol method is the more certain. An ordinary catheter *in situ* is filled with collargol, and radiographed, or the radiogram is taken while the collargol is trickling down the ureter from the pelvis of the kidney.

**Strength of the Solution employed.**—Solutions of from 3 to 20 per cent are employed, but 10 per cent is the most usual strength. The strength employed should be selected according to (1) the stoutness of the patient ; (2) the degree of hydronephrosis, if this be present. A weak solution should be employed if an abnormal shadow has been detected in the renal pelvis, for should there be a stone in the pelvis or calix, and too strong a solution be used, it is probable that the collargol shadow may obliterate the one of the calculus.

**Dangers arising from the Use of Collargol.**—(1) Cases of sepsis have been reported ; (2) areas of necrosis, infarct, and cast formation have been known after the distension of the pelvis under high pressure. Strassmann has carefully investigated these points, and has come to the conclusion that the injection of collargol in proper quantity and under moderate and careful pressure causes no harmful results.

**Sacculi of the Bladder.**—These may be shown radiographically, but solutions of barium sulphate are used instead of collargol on account of the cost. Two parts of barium sulphate are suspended in ten parts of oleum amygdalæ dulcis, and this suspension corresponds well with collargol solution in density of shadow produced.

## Congenital Malformations

All varieties are met with in the routine examination by X-rays. Valuable information may be obtained as to the presence of these abnormalities, their form and extent, and light is thrown upon them from the operative point of view.

It is impossible to give a complete account of the departures from the normal which occur in all parts of the body, but a few of the commoner instances may be mentioned ; several are illustrated in Plate LIV. The skull frequently presents departures from the normal, in ossification, and absence of sinuses, notably the frontal, where there may be practically no air-cells, or a very small one may represent the frontal sinuses. The sinuses may be abnormally large, and extend over the greater part of the frontal bone ; one side may be quite normal or greatly enlarged, while the other is absent. Similarly the mastoid air sinuses may vary to a like degree. Abnormalities in the eruption of the teeth are often seen. In the thorax the viscera may be transposed, the heart being on the right instead of the left side, the aorta being similarly displaced. The stomach is occasionally found on the right side, the liver being then on the left. The cæcum and appendix may also be found on the opposite side. The kidneys may be represented by a single horse-shoe-like structure, or a kidney is found on the one side, the other being absent. It is important in connection with kidney operations to bear this fact in mind.

Many deformities of the bony skeleton are met with. One arm may be represented by a small atrophied structure which may have the bones complete or may show remarkable variations from the normal. The forearm may show a variety of departures. Congenital absence of a bone is not uncommon. The wrist and hand may be represented by a small fleshy mass with a number of partially ossified bones in its interior, or the fingers may be webbed or joined by bone to each other. The value of a radiographic examination in these cases is great, for by its means it is often possible to determine if the condition can be remedied by operative measures.



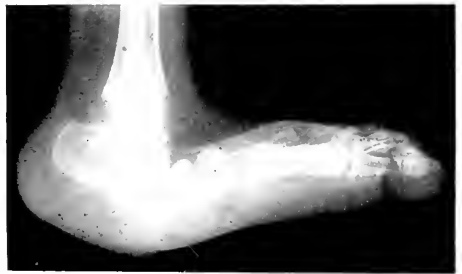
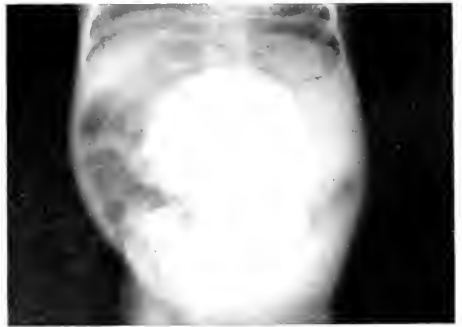

PLATE LIV.—CONGENITAL DEFORMITIES.

- a.* Meningocele in an infant.
- b.* Congenital deformity of foot (Talipes valgus).
- c.* Photograph of congenital deformities of hands.
- d.* Radiograph of above.



PART II  
RADIATION THERAPEUTICS



## INTRODUCTORY

The treatment of disease by radiation naturally divides itself into :

- (1) Treatment by X-rays ;
- (2) Treatment by Radium.

The physics of radium is briefly described in a separate section, and the production of X-rays is dealt with in the section on radiography. A separate section of the book is devoted to the consideration of practical points in the use of X-rays and radium, but it will be well here to give a brief summary of the general effects of radiations on tissues.

It is assumed that the action is being produced by the radiations from whichever agent is being used, and that the particular effect is dependent upon the quality of the radiation, so that it is immaterial from which source it is derived.

The work of Wickham in the early days of radium therapy, particularly in the treatment of superficial lesions, indicated a large field of usefulness. Dominici, working almost exclusively with the Gamma ray, demonstrated that far-reaching effects could be produced by filtering the radiations, so as to exclude all but the Gamma ray, and for a time this method was largely employed in the treatment of malignant disease. It has been found, however, that excellent therapeutic results can be obtained when the filtration is not nearly so great. These effects must be due to Beta and Gamma radiations. A filter of .3 mm. of platinum cuts off a fairly large proportion of Beta rays, but allows 25 to 30 per cent. of these rays to pass through, and exercise an effect upon the tissues. There is therefore a tendency now to cut down the filtration in order that the therapeutic action of both rays may be employed. This is particularly so when radium tubes are buried in the substance of tumours.

The biological reaction of tissues to radiations is another factor which must always be taken into consideration, and one which will always remain the deciding factor in the choice of the quality and quantity of rays to be employed. That is, it will decide the question of filtration and time of exposure. It is this factor which makes radiation therapy so difficult, and largely explains the diversity of results obtained by many workers. It is, for instance, a common experience to find two growths of apparently similar nature responding differently to, as far as can be judged, precisely similar conditions of ray and dosage.

The employment of the hardest X-ray it is possible to produce at the present time is sometimes followed by marked results in the treatment of various forms of carcinoma. This hard X-ray has not nearly the penetrating power of the Gamma ray of radium, yet in some cases its therapeutic action is quite as marked. It would appear, therefore, that a wide range of choice in radiation exists in the field of practical therapeutics. It is sound policy, in the present state of our knowledge, to combine the two agents whenever possible. For example, a carcinoma of the breast may receive thorough X-ray treatment as a preliminary to the introduction of radium tubes into the substance of the growth. The advantage of using X-rays lies in the fact that treatment may be quickly administered over a wide area, including the growth and its lymphatic distribution. The resulting reaction may lead to a limitation of the growth, and in some instances to a rapid diminution in size. The radium tubes may be introduced into the substance of the growth, and continue the action of the X-rays at a deeper level. Subsequently the X-rays may be applied at regular intervals as long as is necessary. Patients so treated undoubtedly receive great benefit, both locally and constitutionally.

### **Action of Radiations upon Tissues**

The action of radium and X-rays upon the normal tissues and on morbid growths is not as simple as it appears. It is not purely a caustic action, though caustic effects can readily be produced if the exposure is overdone, or the filtration not sufficient. In some growths this action is deliberately made use of in order to produce necrosis of the mass, in the hope that when the slough separates normal tissues will fill in the resulting ulcer. On the other hand, enlarged glands sometimes disappear with hardly any skin reaction. One case of recurrent sarcoma of the neck completely cleared up, with merely a slight reaction of the skin surface, and no permanent damage. A case of epithelioma of the tonsil, involving the uvula and soft palate, practically disappeared, leaving a healthy soft palate and uvula.

In addition to the direct evidence of a local action of radiations upon the cell of a new growth and its surrounding tissues, there is reason to believe that a general effect is produced upon the whole body. This is indicated by the fact that patients undergoing treatment by X-rays or radium occasionally improve markedly in general health. They gain weight, improve in colour, and when the blood is examined an improvement is seen. As an illustration of this beneficial effect, a case may be mentioned where treatment of an ulcerated carcinoma of the breast was followed by a marked improvement in a foul vaginal discharge from which the patient suffered. While growths of the breast are being treated it is not uncommon to find glands in the axilla and other parts diminish in size. This is also observed when cases of sarcoma, lymphadenoma, and other diseases are treated. Whether this is the result of a general stimulation or an auto-vaccination is a point which has yet to be determined. Experimental evidence is forthcoming which goes

to show that cancer which has been treated with X-rays or radium does not grow so rapidly when injected into mice as growth which has not had such treatment. It is extremely probable that radiations of X-rays, radium, and similar agents, do exercise a general as well as a local effect upon living organisms. The general effect may be quite as useful as the local, and if it has any value at all, it would be extremely useful to bear in mind, because one need not then limit the area of exposure. After local treatment has been pushed to its limit the treatment may be continued in other parts of the body.

The following observations made on patients undergoing treatment for malignant disease may throw some light on the problem which has been engaging our attention for so long. In the course of treatment of cases of leukaemia the fact has been observed that marked changes, *e.g.* a diminution in the number of white blood corpuscles, relative and absolute, can be induced in the blood by radiations. These changes are obtained when the splenic area is irradiated, as has most generally been the method of treating this disease. The same changes may be brought about when other parts of the body are subjected to treatment; thus the irradiation of the ends of the long bones or areas of the abdomen results in a change in the percentage of blood cells and a reduction in the size of the spleen. Observations such as these lead us to infer that the beneficial effects of X-rays on certain cases of this disease may be due to a general as well as to a local action. Further, it has been observed during the local treatment of carcinoma of the breast, that glands at a distance which have not received any direct treatment have slowly diminished in size. It has also been noticed during the treatment of such diseases as tuberculosis, lymphadenoma, and sarcoma, that, while the local condition has improved as a result of direct treatment, the more distant glands have also diminished.

The writer has for several years been making observations on blood changes induced in patients undergoing treatment by radiations. At the commencement of these observations the whole attention was directed to the white blood cells, which were observed to vary considerably at different stages of the disease according to the accompanying infection, and also as a result of destructive changes occurring in the tumour and surrounding tissues.

More recently attention has been directed to the behaviour of the red blood corpuscles under similar conditions. As an outcome of these observations it can be stated that in the cases where the percentage of red blood cells is normal or over and the hæmoglobin is 100 per cent. or almost so, the response to treatment is more rapid and lasting than when, as is so frequently the case in advanced stages of malignant disease, the percentage of red cells is much below the normal. In several patients whose response to X-ray and radium treatment has been rapid and marked, the percentage of red cells has been well over the normal. One case recorded well over 8,000,000, and the hæmoglobin colour index stood at 100 per cent. Nearly every case which showed a normal or plus normal condition of the red cells responded well to X-ray treatment.

In view of the excellent work done on secondary radiations of metals by Barkla, Sadler, and others, and the valuable work done by Hernemann Johnson in the application of metals to produce the secondary radiations in the tissues of patients treated by X-rays, the most likely explanation of this remarkable response in these cases is that in the blood stream there exist materials which, when bombarded by the radiations of X-rays or radium, throw off secondary radiations which in some way act on the normal and abnormal tissue, stimulating the former, and in some instances damaging the latter, and leading to a diminution in the size of the tumour. The most likely material to give off secondary rays is the hæmoglobin of the red cells, which is a compound of iron. The latter metal is known to give off secondary radiations when exposed to X-rays. It is interesting to note that iron stands high in the list of metals which give off radiations when struck by X-rays. These radiations are independent of the chemical combination of the metals, and only depend on the quantity of the metal present. It must be borne in mind that metals require a particular hardness of X-ray to enable them to emit the characteristic secondary radiations peculiar to them. This may in part account for the marked degree of action produced in cases which have a high percentage of hæmoglobin. It also throws some light on the cases which have failed to respond; possibly the particular quality of X-ray employed has not been the right one, or the exposure has not been long enough. In the writer's own experience the best results have been obtained when using the hardest X-ray possible, combined with aluminium filters.

The hard Beta rays and the Gamma rays from radium appear to exercise a marked influence upon some cases of cancer. The duration and frequency of the exposures also play an important part in the results. At present experience alone can show us how and when to repeat the radiations. When the necessary secondary radiation values of the constituents of a malignant growth and of the blood and lymph and the substances they contain are known, and when improvements in X-ray tubes and control apparatus enable us to select the ray which will cause it to emit its secondary radiation when it strikes upon, say, the iron in the blood, we may hope to produce a reaction in and around the growth which should materially help us in treatment. Then we may hope for marked improvement in results. It is probable that we have here also an explanation of the changes which may be induced in the more distant parts; the blood which receives local treatment in its passage through the growth and surrounding tissues is acted upon by these radiations, and the effects produced on the cells in the local growth are carried on to the other parts of the body, and exercise a stimulating effect on tissue metabolism, which may result in changes in these parts. The suggestion is, I think, one well worth careful consideration and investigation, for here we possess an excellent vehicle by means of which we can obtain secondary radiations from direct radiations upon particular parts.

The obvious inference is that in all cases of malignant disease we should endeavour to keep the red blood corpuscles up to or above normal and



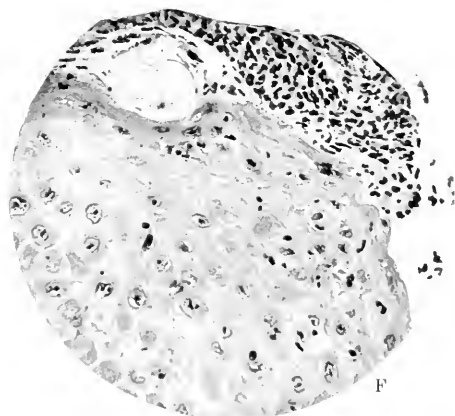
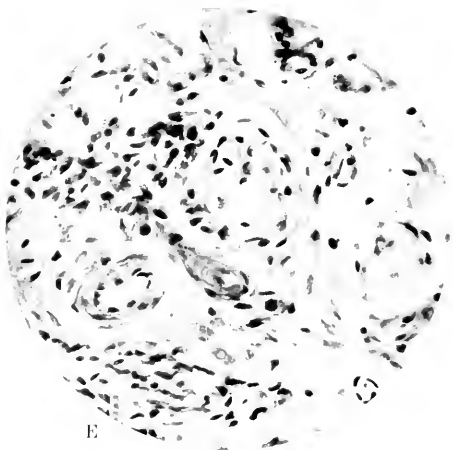
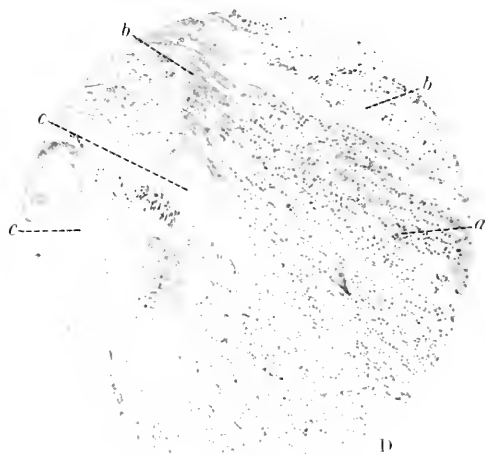
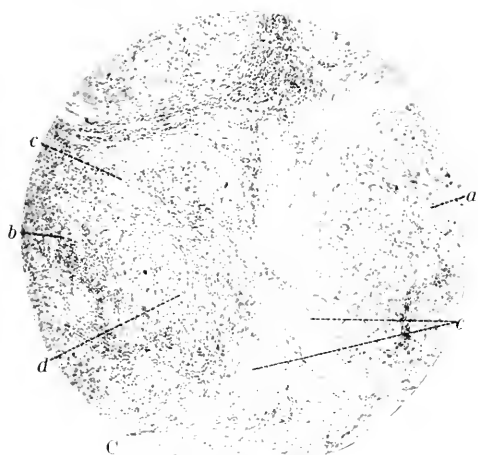
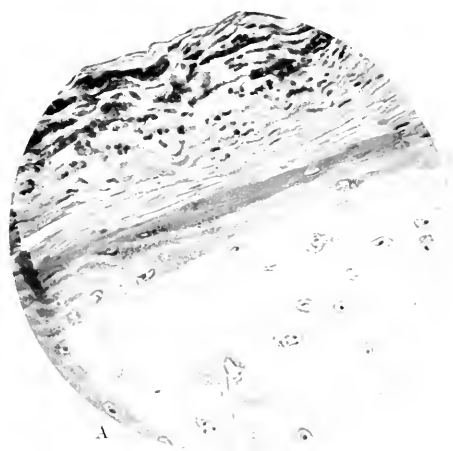

PLATE LV. — CHANGES PRODUCED IN NORMAL TISSUES BY RADIATIONS.

A, High-power magnification. Leucocytes in corneal layer of epithelium, squamous cells degenerated, changes in nuclei.

B, High-power magnification. Leucocyte infiltration of an ulcerated surface, obliterated blood-vessel in a mass of degenerated squamous cells.

C, Section showing changes in bundles of muscle fibres, partial destruction of two small bundles (*a*), small round-celled invasion (*b*), increase of fibrous tissue between the muscle fibres (*c*), and atrophy of fibres (*d*).

D, Muscle fibres in longitudinal section. (*a*) Small round-cell infiltration; (*b*) loss of striation of muscle fibres; (*c*) replacement of muscle fibres by fibrous tissue.

E, High-power view, showing two small nerves and a blood-vessel surrounded by well-formed fibrous tissue; also many young connective-tissue cells. There are a few fibro-blasts in the large nerve trunk.

F, High-power magnification. Squamous epithelioma with patches of round-celled inflammatory exudation on surface. The squamous cells next to this are large and irregular and a few leucocytes have penetrated between the cells.



increase the colour value by giving the patient iron and other drugs which are known to exercise a tonic effect while we bombard the local condition with regular doses of radiations. Recently some cases undergoing radiation treatment have also received injections of salvarsan; the response to this combined treatment has been very marked, the improvement being greater and more rapid than when either is used separately. It is necessary, however, to watch carefully the action of both treatments, and especially that of the radiations, care being taken not to press the dosage too rapidly, in order to avoid the danger of too sudden and far-reaching changes in the blood and tissues. The radiation employed should be of a quality which is known to produce the secondary effects upon the iron and other substances capable of producing secondary radiations in the blood. The treatment of malignant growths must therefore be general as well as local. The general treatment consists of a suitable diet, plenty of fresh air, and iron tonics—the latter in excess if the patient is tolerant.

Rest in bed during treatment should in some cases be insisted upon. The local treatment should consist of such measures as will induce a liberal flow of blood to the part, *e.g.* :

(a) Brush high-frequency discharges, which are very useful for this purpose, and which should be given just before or at the same time as the X-ray treatment.

(b) The mercury vapour lamp, which also induces an increased superficial blood flow.

(c) Diathermy. This form of high-frequency current is said to increase the sensibility of tissues to the action of radiation. Previous to radiation treatment the parts may be thoroughly exposed between two electrodes, and radiation treatment then applied. Also, the X-ray or radium exposures should be of sufficient duration to induce and keep up in the tissues a moderate degree of reaction.

It has been observed in treating superficial carcinoma that improvement hardly ever takes place until this degree of action is produced. In severe cases the reaction may require to be marked. Under treatment of this kind recurrent nodules and primary growths of considerable size frequently diminish considerably, and larger tumours become smaller, and in some cases are rendered operable. Recurrent nodules and small primary growths sometimes entirely disappear. It is also possible that the blood serum may contain substances which give off secondary radiations which alter the composition of the serum. A great deal of work has been done in this direction. Future research in the investigation of physical phenomena should be directed on lines which are likely to throw light on the action of secondary radiations in the tissues themselves. By a combined attack from the physical and clinical aspects, we may hope in the near future to produce a marked improvement in our methods of treatment by radiations, which should result in material benefit to patients suffering from malignant disease.

## Action of Radiations on Normal Tissues and Morbid Growths

That radium exercises a marked influence upon tissues and tissue metabolism is an admitted fact, but the nature of this influence is still imperfectly understood, and must necessarily remain so until we know more about the biological effects of radium.

All the early work was carried out under conditions of partial knowledge. The results varied as a consequence, and hence conflicting opinions were promulgated, in many cases hastily, on the value of radium in therapeutics.

It may be stated at the outset that all living tissues are affected by the various rays from radium—Alpha, Beta, and Gamma—to an unequal extent, varying with the particular rays which predominate in the exposure. The predominance of any particular rays depends upon the quantity of radium used, the filtration, the distance of the applicator from the tissues in question, and the length of exposure.

**Action on Normal Tissues.**—Radium acts as a stimulant to normal tissues, causing congestion of the areas exposed to its radiations, which congestion is followed by an increased formation of fibrous tissue. If the exposure is prolonged, or the filtration insufficient, the action of the rays becomes a caustic one, and an acute inflammatory process is set up, which may go on to necrosis and sloughing of the tissues exposed.

When the exposure has been accurately calculated, the inflammation slowly subsides after a given time, the deeper tissues participating in the reaction in a diminishing ratio, according to their depth from the surface. There is in all the tissues an inflammatory condition, with a leucocyte migration and an invasion of small round cells. When this subsides fibrous tissue formation begins, and the newly formed connective tissue with its capillary blood-vessels may surround individual cells or areas of cells, and by subsequent contraction cut off the blood-supply of these areas, which then undergo atrophic changes. Large areas of debris may be seen in the section examined.

*Action on the Skin.*—A section from a portion of skin adjacent to a new growth which was treated with radium shows a well-marked leucocyte infiltration in the cornual layer of the epidermis. The squamous cells are degenerated and have lost their nuclei. These changes are noticed when the skin has been subjected to prolonged exposures, the atrophy of the skin bearing a direct relation to the duration of the exposure. Skin so treated recovers its normal condition if the exposure has not been too great. The atrophic changes will increase as the dose increases. The degenerative changes occur in all the structures forming the cuticle, hair-bulbs being damaged or destroyed.

*Action on Hair.*—Hair in the neighbourhood of an area treated by radiation will lose its vitality and fall out; a permanent alopecia may follow.

*Nerve Tissue.*—Nerve fibres may become influenced, and a condition of

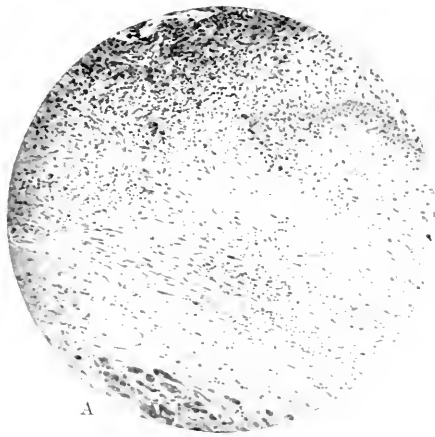

A

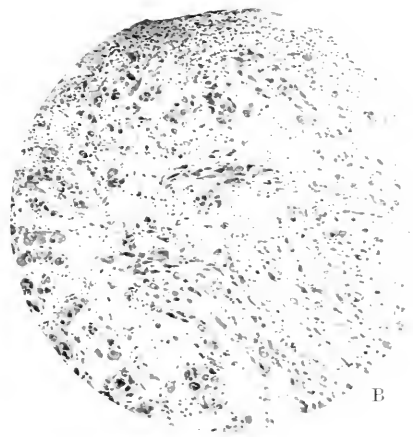

B

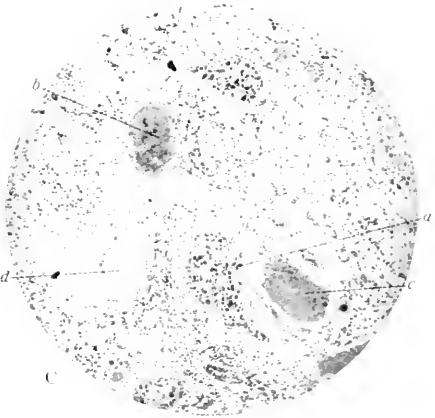

C

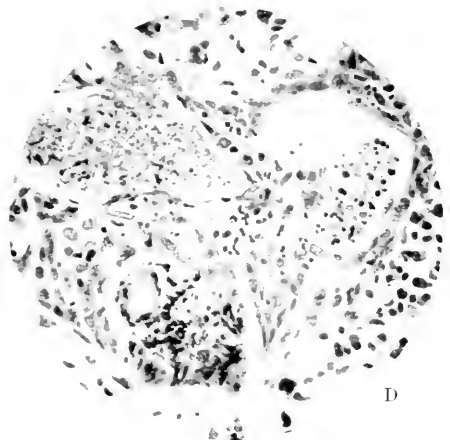

D

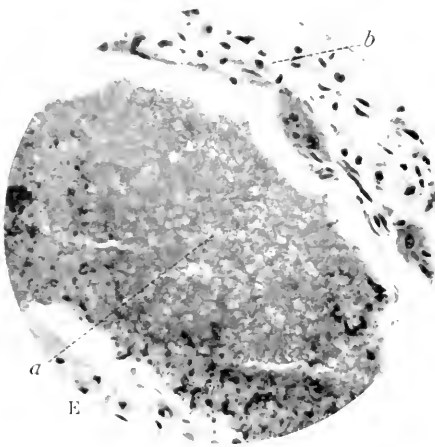

E

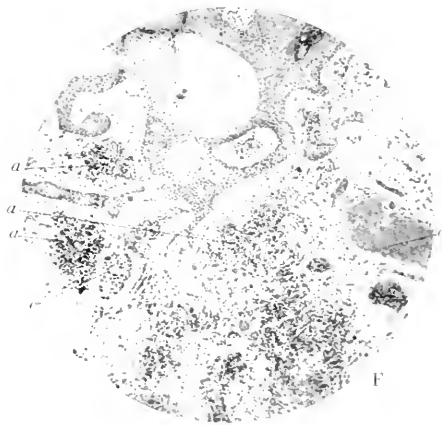

F

PLATE LVI.—CHANGES OBSERVED IN TUMOURS WHICH HAVE BEEN TREATED BY RADIATIONS.

A, Low-power view, much fibrous tissue with many young connective-tissue cells and a large number of black dots representing small round inflammatory cells. An interpapillary process of squamous cells is seen on the upper right side. Below are seen numerous large cells in small clusters surrounded by fibrous tissue.

B, Collection of large irregular cells embedded in hyaline tissue—fibrous; many of the cells are of the typical squamous type. There are many small round inflammatory cells scattered throughout the section in the connective-tissue stroma. The upper part represents the ulcerated surface of the tumour and is composed of a layer of fibrin and leucocytes.

C, Low-power view from a case of carcinoma of the breast, treated with X-rays and radium, showing groups of cancer cells undergoing degenerative changes. (*a*) Fairly active group, (*b*) more advanced degeneration, (*c*) hyaline degeneration, (*d*) a mass of fibrous tissue.

D, High-power view of several groups of cancer cells showing various stages of degeneration.

E, High-power view of portion marked *c* in C; the mass is filled up by granular debris *a*; *b*, round-celled infiltration.

F, A section from a case of carcinoma treated with radium, showing excessive fibrous-tissue formation; (*c*) groups of cancer cells undergoing degeneration.



neuritis or perineuritis be set up. This may give rise to a considerable degree of pain.

*Action on Sweat Glands.*—These are readily affected by radium rays. The preliminary change will be a stage of engorgement of the surrounding vessels and the atrophy may be marked. Complete destruction of the gland will be the result of over-exposure, the gland becoming involved in fibrous tissue. This action on sweat glands may be employed in therapeutics, when radium may be used instead of X-rays.

*Muscle Fibres* undergo a degree of degeneration. A loss of striation is seen, and a form of hyaline degeneration follows. The muscle bundles are invaded by small round cells, and fibrosis of the bundle can often be observed in sections. These changes are seen in Figs. C and D, Plate LV. Fig. C shows a transverse section of bundles of muscle fibres which were removed from a patient who was treated with radium. The section shows bundles of muscle surrounded by well-formed fibrous tissue which has invaded and partly destroyed two of the smaller bundles. There are many small round inflammatory cells occupying the fibrous tissue and in parts lying between the muscle fibres. The general appearance is suggestive of the changes seen in cirrhosis of the liver. The longitudinal section seen in Fig. D shows at (a) the small round cell infiltration, at (b) muscle fibre which has lost its striated appearance, and at (c) the dense fibrous tissue.

*Blood Vessels.*—The vessels are involved in the general inflammatory process. There is a proliferation of the endothelium of the small capillaries, which leads to occlusion of the lumen, and consequent arrest of the circulation. The large vessels show a proliferation of the intima, and occasionally a vessel may be seen with the lumen occluded.

Fig. B, Plate LV, illustrates a blood-vessel in a section which shows leucocyte infiltration of an ulcerated surface. An oval patch to the left of the section represents a blood-vessel which has become occluded and is situated in a mass of degenerated squamous cells. Fig. E of same Plate is a high-power view of a section showing two small nerves and a blood-vessel surrounded by well-formed fibrous tissue.

**Action of Radium on Vascular Connective Tissues.**—The disappearance of inflammatory conditions and tumours on which radium exercises an action eventually depend upon two phenomena, which are as follows :

(1) The destruction by radiations of the anatomical elements modified by inflammation and by the progress of the tumour.

(2) The absorption of degenerated tissue by the phagocytes, and its replacement by sclerotic tissue.

Wickham and Degrais admit that these phenomena may account for changes which occur in some affections treated by radium, but point out that this is not the only result of the process when radium is employed on inflammatory conditions, on tumours of the connective tissue, and on epithelioid tumours. Instead of hastening the degeneration of connective tissue cells injured by inflammation or by the progress of the tumour, the

radium rays revive the vitality of these elements, and subject them to an evolution differing from that which the pathogenic influences were producing. The special action of the Becquerel ray is then substituted for that of the pathogenic process. Their effects are manifested either by the arrest of the inflammatory process or by the resolution of the tumour, and by a change of structure in the connective tissue. The above argument is open to criticism in that it presupposes a selective action of radiations upon pathogenic processes and connective tissue elements. The question is fully dealt with later on, but it may be said here that the difficulty can be as well solved by the theory that as radium acts on all tissues in varying degree according to the susceptibility of the cell, different results are obtained when the tissues are more resistant than when they are less so. If the tumour elements were stimulated as well as the connective tissue cells, their increase in growth would lead to an increase in the size of the tumour, and thus the pathogenic processes referred to above would predominate and lead to a further destruction of the anatomical elements. On the other hand, should the connective tissue cells receive the more powerful stimulation, their increase would be the dominant factor. It is thus possible to explain all the changes induced in the tissues without claiming a selective action for radium. Wickham and Degrais, however, further argue: "This change consists (*a*) in a metamorphosis of the vascular connective tissue into angiomatous embryonic tissue; (*b*) in transformation of this embryonic tissue into connective fibrous tissue of regular texture. In such a case the healing of inflammatory conditions or of tumours is the function of a special cellular evolution produced by the Becquerel rays. The healthy connective tissue itself undergoes this evolution."

**Action of Radiations upon Tumour Cells.**—Occasionally enlarged glands are reduced in size with hardly any skin reaction; nothing more than a slight erythema may be produced even after repeated exposures to the same area of skin, yet the enlarged glands situated at a much deeper level slowly diminish in size.

Malignant indurated ulcers will rapidly break down and heal under the action of radium.

The degree of action induced is dependent upon the method of application. The various degrees of tissue change depend upon the filtration employed and the length of the exposure. Thus, if necrosis of the growth is necessary, a thin filter would be used and a long exposure given. Here we are making use of the Beta ray almost entirely. Should it be necessary to act on a deeper structure and at the same time protect the skin from such action, a thick filter of platinum or lead is used. Two millimetres of platinum or four of lead are sufficient to cut off all but the hardest of the beta rays, while the gamma ray is unaltered. The filters containing the radium are enclosed in a rubber tube to prevent the secondary radiation induced in the platinum by the radium rays from damaging the superficial structures. If the exposure be long, further protection can be secured by using an inch or more of lint or gamgee tissue. In this way we can control the exposure so that we get



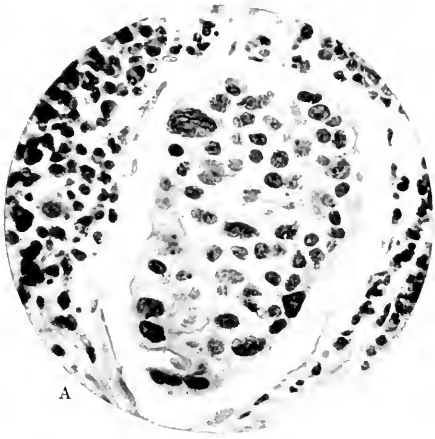

A

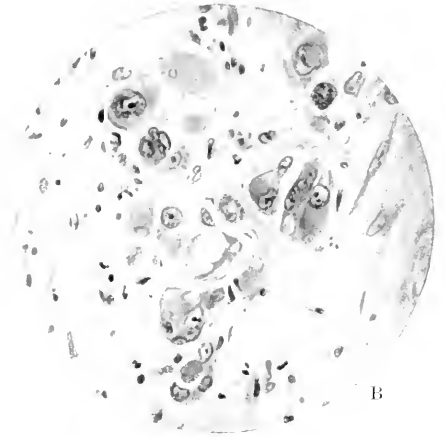

B

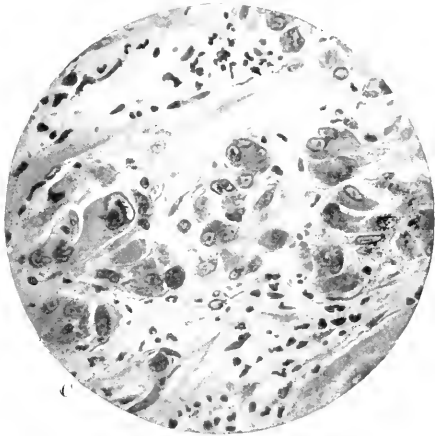

C



D

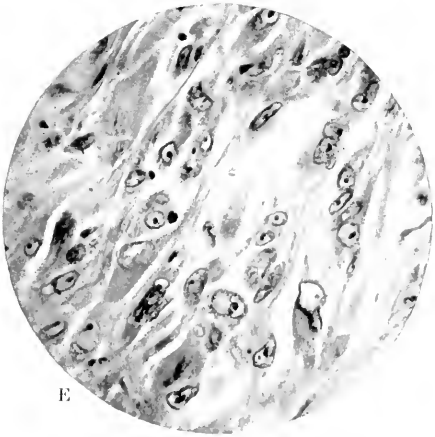

E

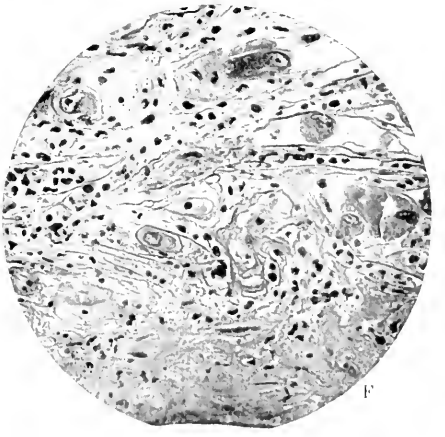

F

PLATE LVII.—CHANGES OBSERVED IN TUMOURS WHICH HAVE BEEN TREATED BY RADIATIONS.

- A. High-power magnification from portion of Plate LVI, F, marked *a*.
- B. High magnification of groups of cancer cells. Cells large and very irregular in shape, exudation is marked in one group of cells, other cells show division of nuclei.
- C. High magnification of groups of cancer cells embedded in fibrous matrix, leucocyte infiltration.
- D. High magnification. Another field from same section showing somewhat more advanced changes of a like nature.
- E. High magnification, showing a mass of cellular growth, with very little fibrous tissue, cells large and elongated, nuclei irregular and nucleoli well shown.
- F. High magnification showing fibrous tissue and leucocytes at surface with hyaline changes; large irregular cells lie in loose tissue, they are pale and suggest degenerative changes.



nearly the pure gamma-ray effect. This enables us to get an action upon the deep-seated parts.

It has been claimed that radium possesses a "selective action" on cancer cells. While admitting that it undoubtedly appears to act on such cells, the word "selective" is badly used. Radium exercises an action on all living cells in a varying degree according to the resistance of the particular cell in question. Thus, young actively growing cells are more readily influenced than mature cells. The cells of a new growth approximate in structure and power of resistance to the actively growing cells of a tissue. In this way it is conceivable that the cancer cell is influenced should it at the time of exposure be comparatively early in its life-cycle. Should the cancer cells be of a stronger or more vigorous type, it is conceivable that the action of the radium may be stimulating, and instead of a decrease in vigour of a particular cell we may find an increase in activity, and a consequent increase in the size of a tumour. It is a fact that some cases of cancer increase in size at a quicker rate after radium has been applied. Some types of cancer are more amenable to radium treatment than others.

The action of radiations upon tumour cells can be seen from a number of photomicrographs from sections obtained during the treatment with radium of cases of growth. These sections are from a number of cases, but some are from the same case at different periods of treatment. They show in some parts marked retrogressive changes.

Fig. F, Plate LV.—A section of tissue adjacent to a carcinoma of the arm which received prolonged radium treatment. There is a marked degree of exudation on the surface. The squamous cells adjoining this are large and irregular, and a few leucocytes have penetrated between the cells.

Fig. A, Plate LVI.—A low-power view of another section from the same patient. There is a considerable increase of fibrous tissue cells, and a large number of black specks represent small round inflammatory cells. An interpapillary process of squamous cells is seen on the upper left side. To the right below are seen numerous large cells in small clusters separated by fibrous tissue. These cells represent all the new growth present in the field.

Fig. B, Plate LVI. shows a small collection of large irregular-shaped cells embedded in hyaline tissue (fibrous). Many of the cells are of the typical squamous type, and are separated by clear intervals, there being an absence of intercellular substance. The upper part represents the ulcerated surface of the tumour, and is composed of a layer of fibrin and leucocytes.

Fig. C, Plate LVI.—A low-power view of a portion of tumour removed from an atrophic cancer of the breast after repeated X-ray exposures, followed by one exposure to radium, applied directly over the portion of growth removed for examination. It shows groups of cancer cells undergoing degenerative changes. (a) A group of cells which are fairly active. The group is well defined at its edge, and is surrounded by fibrous tissue. (b) A group of cells which have undergone marked degeneration. There are a number of small round cells in the group. (c) A mass of cancer tissue which

shows more marked degenerative changes. (d) Area showing excessive fibrous tissue formation.

Fig. E, Plate LVI.—A high-power view from section C shows a large mass of cancer cells which have undergone degeneration, the place of the cells being filled by granular debris. At the edges, small round-cell infiltration is seen.

Fig. D.—A high-power view of a portion of tissue from the same case, showing stages of degenerative process.

Fig. F.—A section from a case of carcinoma of the breast, showing (1) excessive fibrous tissue formation; (2) malignant cells in various stages of degeneration.

Fig. A, Plate LVII, is a higher magnification of a portion of Fig. F in Plate LVI., a group of cells which still retain their activity. Several of the cells appear to have degenerated, and there is evidence of nuclear changes.

Fig. B.—A more advanced stage of change in cells than in preceding figure. The cells are large and very irregular in shape. Vacuolation is marked in one group. Other cells show division of nuclei.

Fig. C.—A group of cells embedded in a fibrous matrix. There is marked leucocyte infiltration.

Fig. D shows a similar condition and a more advanced stage of degeneration in several of the cells.

Fig. E.—A mass of cellular growth with practically no fibrous tissue. The cells are large and generally elongated in shape. The space between the nuclei is irregular and the nucleoli are well marked. This is a condition of the cells frequently seen in these cases. Presumably an active group of cells has been stimulated to increased growth, and some of the cells have been damaged by the radiations.

Fig. F.—A high-power view from a section of growth showing leucocytes at surface with fibrous tissue formation. Large irregular cells lie in a loose cellular tissue. They are pale, and suggest an early stage of degeneration.

Fig. A, Plate LVIII.—A section similar to the last, showing leucocytes in long narrow vessels running between the cells of the growth.

Fig. B.—Another section near the surface of a growth, showing much round-cell infiltration between the cells of the growth.

Fig. C.—A group of large cancer cells in the midst of loose fibrous tissue, with a few round cells interspersed.

Fig. D.—A high-power view from a section showing the surface of the growth. A group of large irregular cells in alveoli separated by loose connective tissue. These cells stain well and have large nuclei, and there are many leucocytes in the stroma. The tissue is denser towards the surface, and certain concentric bodies, the remains of cells of the new growth, are present. The fibrous tissue of the walls of the alveoli of growth collapse as the growth cells are destroyed. The blood-vessels have been obliterated. The surface layers of the tissue are denser than those at a deeper level, probably the results of the action of the radiations.

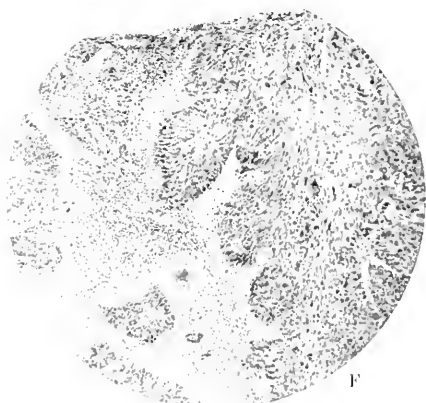
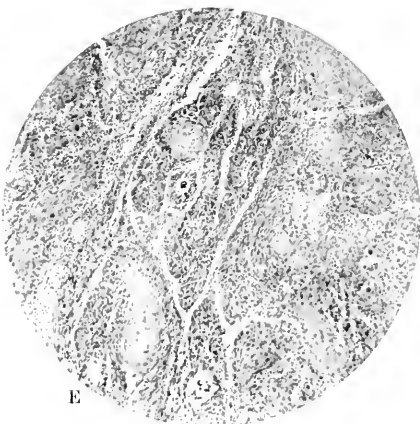
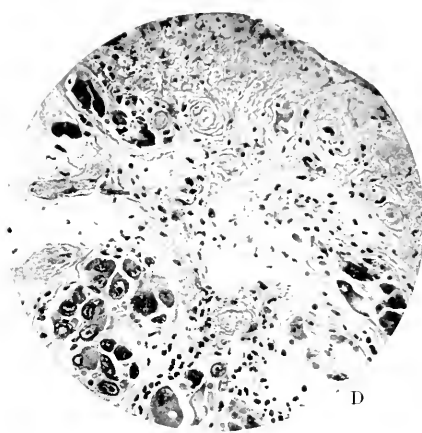
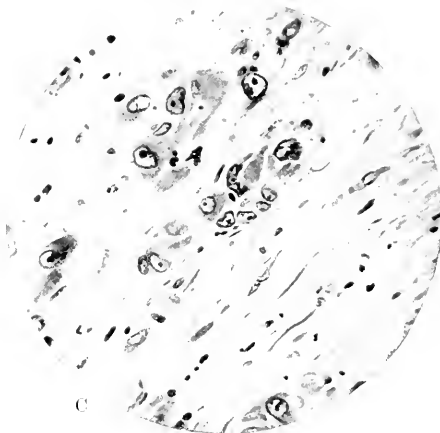
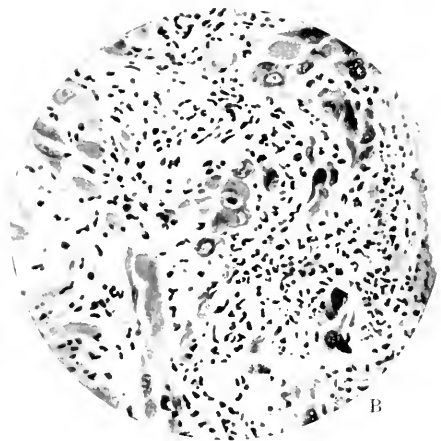
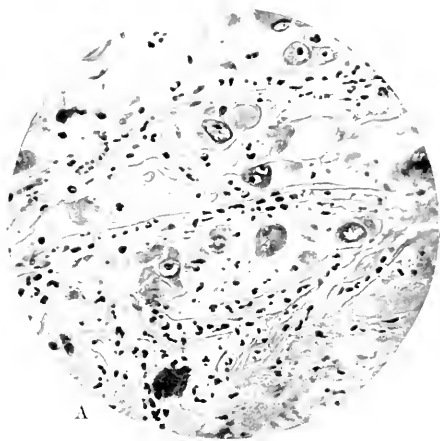

PLATE LVIII.—A TO D, CHANGES OBSERVED IN TUMOURS WHICH HAVE BEEN TREATED BY RADIATIONS.

A, Another view from same section of tissue as F in preceding plate. Leucocytes in long narrow vessels running between the cells of a growth.

B, Another section near the surface of a growth showing considerable round-cell infiltration between the cells.

C, Group of large cells in the midst of loose fibrous tissue; there are very few round cells in the fibrous tissue.

D, High-power view of surface and underlying growth; group of large irregular cells in alveoli separated by loose connective tissue; nuclei are large; tissue denser towards the surface; and connective bodies are seen (remains of tumour cells?) blood-vessels obliterated.

E AND F, SECTIONS FROM A TUMOUR BEFORE TREATMENT.

E, A section from a squamous-celled carcinoma before treatment with radium, showing irregular masses of squamous cells divided by scanty stroma of fibrous tissue, many round inflammatory cells; cell nests.

F, Another section from the same patient; tumour cells irregular in shape with a tendency to cornification towards the centre.



Fig. E, Plate LVIII.—A section from a squamous-celled carcinoma removed from a tonsil before treatment by radium. This patient completely recovered after thorough treatment. The section shows irregular masses of squamous cells divided by scanty stroma of fibrous tissue, in which there are many small round inflammatory cells. A few of these inflammatory cells also invade the groups of cancer cells. The central cells of several of the masses are large, cornified, and form typical cell nests.

Fig. F.—Another section from the same case. A large mass of growth on right, with several offshoots towards the centre. The cells are irregular in shape with a tendency to cornification in the centre. Smaller masses of cells on the left also show a tendency to cornification towards the centre. These are thickly studded with small round inflammatory cells. A few of these round cells are also seen among the squamous cells of the growth.

In addition to the action upon the cancer cell itself, radium acts upon all the tissues composing the growth and surrounding structures unequally. There is a general stimulation of the healthy tissues as a result of radium treatment so long as the exposure is not excessive. If it should be excessive the action is apt to produce a caustic and ulcerative effect, which leads to local death of the tumour and a portion of the tissues around it. This may sometimes be desirable.

When the effect upon the healthy tissues is confined to stimulation, we expect to find an increase of fibrous tissue formation, which shuts off the cancer tissue from its blood-supply and causes the atrophy of such cells. The reparative power of the normal tissues is strengthened, enabling them to cope with the invading cells and lead to their destruction. These changes can be seen in sections removed from cases undergoing treatment.

The changes induced in malignant growths by the action of radium and similar agents are, so far as we can see, indistinguishable from the degenerative changes seen in cases of growth which have received no treatment; but this important point must be insisted upon, that the percentage of cases in which we see these changes is much larger in the group of cases treated by radiations than in the group which has received no treatment.

It must be admitted that occasionally we see a case of untreated cancer diminish in size and, in a very small percentage, ultimately disappear. During the treatment of cancer by radiations it is by no means uncommon in a fairly large percentage of our cases to see a marked diminution in size produced. In a smaller percentage we do see the growth disappear—at all events for a time.

The local disappearance of a growth is not a cure. The disease may have, and in the majority of cases undoubtedly has, extended to other parts of the body. Consequently no case can be said to have been cured until we have given the deeper ramifications of the growth sufficient time to develop and manifest their presence. It is, therefore, important that before we treat the local condition a search be made for secondary deposits. From the point of view of prognosis, this is a most important matter.

**Factors influencing the Result of Treatment.**—In routine treatment by radium, the following factors should always be kept in mind, as a full consideration of all in each case will help us to foretell the degree of action and the result likely to follow from treatment :

- (a) Type of growth and condition of patient.
- (b) Situation of the tumour, size, etc.
- (c) The quantity of radium used.
- (d) The filtration employed.
- (e) The duration of the exposure.

An improvement in the results at present obtainable by radium in the treatment of malignant disease may be obtained :

(a) Larger quantities of radium may be used. Up to the present the largest quantity used has been about 1 gram of pure radium salt. Far-reaching effects may be produced by such treatment, especially if the filtration is great and the exposure prolonged ; yet, even with such a dose, the result in several cases has been temporary benefit only. The type of case so treated has been a deep-seated growth, which could only be acted on by the very penetrating rays. For surface lesions the increased dosage may have a speedier effect, which should help to prevent the spread of the growth to deeper structures if it can be efficiently checked.

(b) A more thorough knowledge of the physical properties of radium may enable us to select for particular cases the quality of radiations likely to influence the cell metabolism.

(c) It must be admitted that the technique has hitherto been more or less faulty. A fuller knowledge of the influence of the various thicknesses of filters may help us to get speedier results. It may be that the use of the Beta rays in some cases would lead to better results. Similarly the Alpha rays, which up to the present have been little used, may in the future be found to exercise an inhibitory effect upon morbid processes when they are brought into contact with the cells of a growth. The difficulty has been to apply them at all. The radio-active waters at present in use do not appear to have any influence on cancer cells.

It may be possible to deposit the active principles of the radium emanations in such a way that we can utilise them either by direct application or by ionisation with the aid of a galvanic current, or a combination of radiations may be helpful. In several cases radium and X-rays together appear to have hastened reparative processes. It is possible that some of the effects noticed may be due to secondary radiations, produced in the structures composing the growth, which exercise a physiological action. Some such general action appears to take place, because it is quite a common occurrence for patients so treated to improve in general health.

The employment of radiations in any form leads to a constitutional disturbance which we designate as reaction. This varies in time of onset according to the dosage. After a time a period of depression sets in, most probably due to a change set up in the growth which leads to the liberation



of toxins into the circulation. If they are excessive, the condition of the patient may be rendered serious. This form of toxæmia is met with when large rectal growths are treated. It is possible to make the condition of the patient much worse if care is not taken to regulate the dose.

Up to the present the treatment of malignant disease by radium and other radio-active bodies has been purely local. Consequently it cannot be regarded as a specific method of treatment. The conditions under which it may become so are being investigated. The endeavour must be to procure a substance, radio-active or not, which, when introduced into the general circulation, will influence morbid processes in the tissues. It may be possible to use a substance, which when treated locally by radium, X-rays, or other agents capable of exciting the secondary radiations of such substances, will benefit the tissues.

The best we have yet been able to do has been by local stimulation to produce secondary radiations from the tissues, blood, and lymph in the deposits of cancer. When the secondary radiation value of these tissues is better known, and when we know which particular radiation acting upon them will give us their maximum value, then we may hope to improve our results.

## Dangers attendant on the use of X-Rays and Radium

In the routine treatment of disease by radiations, even when the greatest care is exercised as to dosage and frequency of application, it is inevitable that cases should occur in which in spite of all precautions serious damage is done. It is therefore necessary to consider briefly the ill-effects which may accompany the use of radiations. These are :

- (1) Acute Dermatitis.
- (2) Chronic Dermatitis.
- (3) Late Manifestations, appearing a long time after cessation of treatment.

**Acute Dermatitis.**—A properly judged dose of X-rays or radium, when applied to the skin surface after a given time, produces a definite erythema, which causes a slight reddening of the surface. This lasts a few days and then slowly subsides. When such a dose has been applied to a surface covered with hair, complete epilation follows ; the follicles, however, are not destroyed, and the hair reappears later. Should the reaction be excessive, and the skin surface ulcerate, more or less permanent alopecia may result. All degrees of reaction, from a slight erythema to deep ulceration, may follow a single exposure to either X-rays or radium. Acute dermatitis is frequently met with in the treatment of malignant disease where the dosage has been energetically pushed. This may lead to large superficial ulcers, which are extremely painful and very difficult to heal. Deep sloughs may form and separate, leaving large ulcers.

**Chronic Dermatitis.**—The acute dermatitis may only partially subside, and give rise to a subacute or chronic condition which may be very intractable,

persist for years, and finally take on a malignant character. This form is commonly met with among X-ray operators who were injured in the early days of X-ray work. The degree of damage caused to the tissues may be reckoned by the period of incubation, *i.e.* the time between the exposure and the first appearance of redness. Irritation is more marked in the subacute and chronic forms than in the acute, desquamation being more marked in the acute. X-ray warts are a late manifestation of chronic dermatitis, and may become malignant.

**Late Manifestations.**—A frequent sequel to X-ray and radium treatment is the occurrence of telangiectasis many months after the cessation of treatment. The length of time which may elapse between the cessation of treatment and the appearance of telangiectasis is much greater than was formerly supposed. A case was seen recently occurring in the hands where the treatment with filtered rays had been carried out for hyperhidrosis. Three years afterwards the palms of both hands were covered with patches of telangiectasis, with, in addition, a certain degree of pain and irritation. They are somewhat unsightly and difficult to treat. They are more likely to appear when unfiltered rays have been used. Late ulceration is a condition which has been described by several writers as coming on many months, or even a year or two, after the cessation of treatment. It is extremely painful and intractable.

Cases treated by radiations sometimes show evidence of neuritis. This is especially liable to occur in the treatment of cases of carcinoma of the breast in the axillary and supraclavicular regions, owing to the presence of large nerve trunks in these parts. The condition is often very painful, but generally subsides on the cessation of treatment. When very painful, relief may be obtained by the use of the galvanic current along the course of the nerves. It is quite possible that, where deep-seated organs are subjected to heavy dosage in the intensive treatment by X-rays, organs other than those treated may be seriously damaged. A considerable time must elapse before we can definitely state that this intensive treatment cannot produce effects other than those aimed at. In estimating the value of X-ray treatment in myoma uteri, the above possibility must be borne in mind before we can admit the successes claimed for it by enthusiastic advocates. The occurrence of late manifestations on the skin surface after prolonged radiation treatment leads to the inference that deep-seated changes may also occur.

## A. X-RAY THERAPEUTICS

### Special Points in Instrumentation

Before we proceed to a detailed description of the methods of treatment, apparatus, dosage, etc., there are several factors of a preliminary nature which must be discussed at some length.

The general principle of radio-therapeutics is as yet imperfectly understood. The action of X-rays on tissues has been too well demonstrated by the unfortunate effects upon many of the early workers. An agent so capable of harmful effect must necessarily be treated with a considerable amount of respect when used for therapeutic purposes.

There is still a large field for experimental work in the perfection of apparatus, the standardisation of tubes and dosage and therapeutic technique. The early work was chiefly confined to superficial areas of the body, and it was the observation of the effect upon these structures and diseases which encouraged workers to develop and elaborate the technique of the present day. Great improvements in superficial lesions of the skin through the use of X-rays led to the employment of the rays in the treatment of deep-seated diseases. The employment of filters for the protection of the superficial structures from the action of the soft X-rays enabled the experimenters to evolve a technique for the treatment of such diseases as uterine myomata and cancer. The action of the Gamma-ray of radium upon cancer led X-ray therapeutists to use harder tubes and increased filtration with larger exposures. More accurate measures for estimation of dosage increased the value of these experiments, while the improvement in apparatus, particularly in the focus tube, ensured the administration of larger doses of more penetrating rays.

### Methods of Protection

The first care of all workers should be to ensure the complete protection of the operator and attendants in an X-ray department, and there can be no doubt that at present too little attention is paid in most electrical clinics in this country to the important question of X-ray protection.

It is not sufficient to enclose the X-ray tube in a lead-glass shield, closed only on one-half of its diameter. X-rays escape from behind the tube, and in addition there are the rays of which we yet know little, which may have an injurious effect upon the workers; also high-tension currents are allowed to escape through the room, and there is at present no accurate knowledge of the ill-effects which may be produced by frequent and prolonged exposure to their influence.

Complete protection can be obtained by enclosing the X-ray tube, together with the patient and the auxiliary apparatus, within a lead-lined cubicle. Lead of the thickness of 1 mm. or more should be let in between the layers of wood, the wood covering serving to absorb secondary radiations

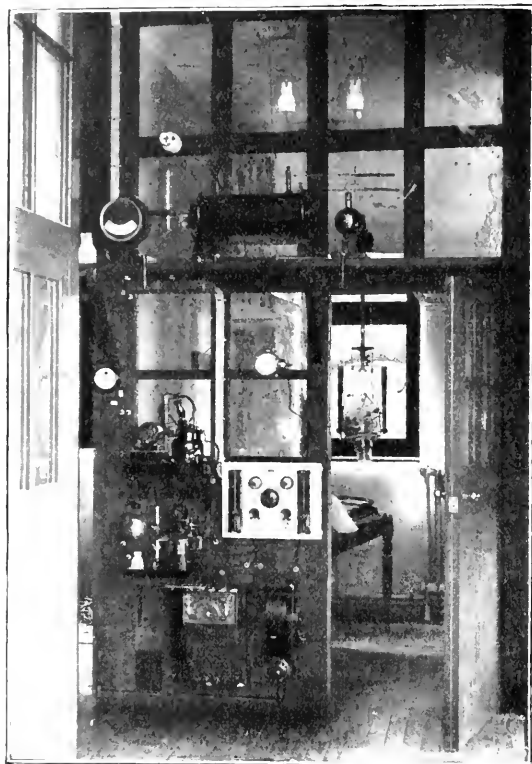

FIG. 185.—X-ray treatment cubicle. (*Archives of Röntgen Ray.*) Control apparatus arranged outside the cubicle.

given off from the lead when struck by X-rays. The upper portion of the cubicle may have lead-glass windows in order that the operator may see the work being done inside. These cubicles should have an efficient system of ventilation. Indeed, too great stress cannot be laid upon this point. All X-ray rooms, cubicles, and dark rooms should be efficiently ventilated, and in hospitals they should also be easy to disinfect. The control apparatus should be on the outside of the cubicle. In some institutions an arrangement is added whereby the current can be automatically cut off when the door of the cubicle is opened.

When such elaborate precautions are not available, it should be the duty

of those responsible for the X-ray department to see that efficient protection is provided. The X-ray tube should be completely enclosed in a lead-lined box, or a lead-glass shield of sufficient size should be provided, so that no stray X-rays are allowed to fall outside the area it is desired to treat. Gloves should be used whenever the operator comes within the range of the rays. A large lead-lined screen should be placed between the active tube and the worker. This should have a lead-glass window for purposes of observation on patient and tube. The control apparatus should be kept at a considerable distance from the tube stand so that the operator need not come near the active ray.

Protection of the patient must be carefully attended to, especially when administering the heavy doses of more recent days. Thick lead-rubber shields should cover the parts of the body in close proximity to the tube box. A window is cut in the middle of the lead rubber to allow of the rays passing

to the part under treatment. The efficiency of the protective measures employed may be tested by means of an electroscope. This, when placed in the vicinity of an active X-ray tube, quickly becomes discharged, thus enabling the ionisation effect to be estimated. All protective devices should be tested in this manner before it is assumed that they are efficient.

### Arrangement of Apparatus

In the early days it was sufficient to have a coil, control apparatus, and a tube, the dose being calculated in minutes, in many instances quite irrespective of the condition of the tube. Even with this crude technique results were obtained which served to call attention to the great potentiality behind the new remedy. Increasing complexity of apparatus accompanied each succeeding development, so that the equipment for an X-ray therapeutic department has now become exceedingly complicated.

The control of the X-ray tube is a matter of ease when precautions are taken and sufficient auxiliary apparatus is provided.

**A Switchboard** on the wall or on a trolley table is essential. It should have an ammeter to measure the primary current, a resistance to control the current in the primary, a resistance for the control of the break, and switches to control these parts.

**Valve Tubes** should be provided wherever there is a suspicion of reverse current. It is a good plan to have valve tubes and oscilloscope tubes arranged so that they may be cut off from the current when not required. They may be introduced occasionally to see if there is any reverse current present. This is all that is necessary when small currents are used.

**A milliamperemeter** measuring approximately the quantity of current passing through the tube, is an essential if reliable work is to be expected. It should be of the very best **D'Arsonval moving-coil dead-beat precision type**, which is provided with two readings, viz., 0-5 and 0-50 m.a. On the lower reading each one-fifth part of a milliampere is clearly registered, while on the higher reading each division of the scale represents two milliamperes. In all ordinary work only one or two milliamperes are utilised through the focus tube, so that the lower reading serves admirably, while for very heavy discharges the higher reading is called into use. The milliamperemeter enables the operator to estimate approximately the hardness of the tube, as the variations may be detected by the fluctuations of the recording needle. As the tube hardens the amount of current passing through diminishes and *vice versa*. In treatment it may be used as a guide to the length of the exposure if care has been



FIG. 186.—Milliamperemeter.  
(Siemens.)

the operator to estimate approximately the hardness of the tube, as the variations may be detected by the fluctuations of the recording needle. As the tube hardens the amount of current passing through diminishes and *vice versa*. In treatment it may be used as a guide to the length of the exposure if care has been

taken to note the condition of the tube as to hardness and quantity of current when a particular dose is being given.

The **Qualimeter of Bauer** is a useful adjunct to a treatment outfit, enabling one at a glance to estimate approximately the degree of hardness of the tube.

*Bauer's Qualimeter.*—The instrument is suspended from the wall of the protective house or protective screen, and indicates the hardness of the focus tube on a scale. It does not depend, as in other scales, on the comparison of different tints.

This instrument is connected by a wire to the negative terminal of the coil or the cathode of the tube. It is a static electrometer and condenser which indicates automatically the potential of the cathode, and hence the quality of the X-rays. The apparatus consists of two wings, which swing between two fixed plates. Both wings and plates are equally charged so that a repulsion takes place between them. The intensity of this repulsion is in exact proportion to the electrical tension in the secondary circuit, and is indicated by the deviation of a pointer over a suitably divided scale.



FIG. 187.—Bauer qualimeter. (Favre.)

As is well known, the penetration of the X-rays is a function of the electrical potential in the secondary circuit, so that a simple measurement of this potential between the anode and cathode will give us an indication of the hardness of the tube. The scale is gauged according to the absorption of the X-rays by sheets of lead of different thickness, increasing regularly from  $\frac{1}{10}$  of a millimetre to 1 millimetre.

No. 1 on the scale denotes X-rays of such a hardness as to be totally absorbed by  $\frac{1}{10}$  millimetre of lead. When the index is at No. 10 we know that the tube is giving out rays which will penetrate 0.9 millimetres of lead, but will be totally absorbed by 1 millimetre of lead.

As already explained, the instrument is unipolar, being joined up by a single wire to some point in electrical connection with the cathode. The instrument is contained in an ebonite case, which swings freely from a bracket on the wall or a stand, so as to be always in a vertical position. It should be within view of the operator, to enable him to estimate the hardness of his tube throughout the whole of the exposure, without danger to himself.

COMPARATIVE SCALE OF THE USUAL INSTRUMENTS FOR MEASURING THE HARDNESS OF TUBES

	soft			medium				hard			
Bauer . . . . .	1	2	3	4	5	6	7	8	9	10	
Wehnelt . . . . .	1.5	3	4.5	6	7.5	9	10.5	12	13.5	15	
Walter . . . . .	1	1.2	2.3	3.4	4.5	5.6	6.7	7.8			
Benoist . . . . .	1	2	3	4	5	6	7	8	9	10	

It is well to have all these instruments—valve tubes, milliamperemeter, qualimeter, and oscilloscope tube—in the circuit, especially when a great deal of work has to be done, as they facilitate speed in working, and enable the operator to see that the conditions under which his work is being carried out are correct.

The Therapeutic Coil should be at least twelve inches spark-gap, and where more than one is possible a 16-inch coil should be installed. Any modern coil is adequate, but the type likely to give the best results is one of

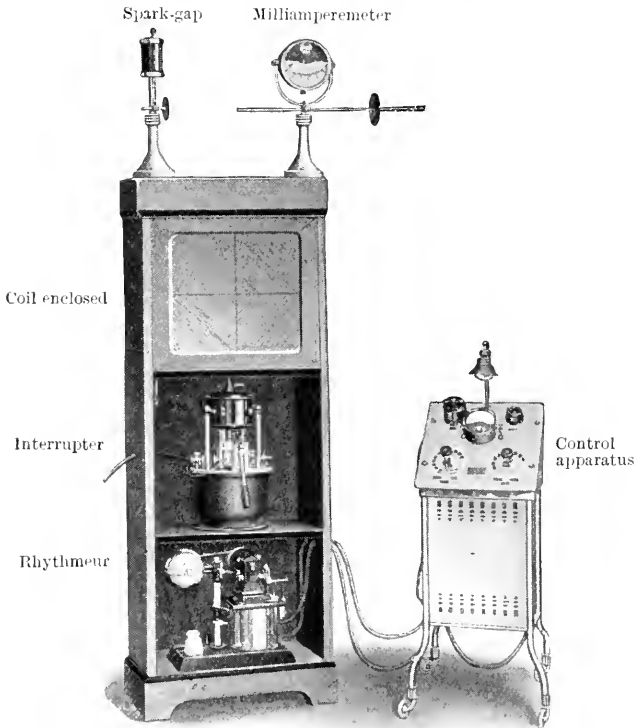

FIG. 188.—Therapeutic outfit suitable for deep therapy. (Schall.)

The interrupter is arranged for the passage of heavy currents. At the top of the motor a small fan is arranged to drive a current of air through the primary of the coil for cooling purposes. A rhythmneur is arranged below the mercury interrupter.

the so-called intensive coils; that is, one giving a high secondary output with a moderate primary current. When possible, the coil should be mounted well away from the control apparatus, and the terminals, high-tension cables, etc., should be separated as widely as possible to prevent a leak to earth or sparking between the terminals. With the larger coil it should be possible to pass heavy discharges through the hardest X-ray tube. The Coolidge tube requires, when very hard rays are used, a heavy discharge from the secondary. This may be obtained from the larger coils now in use. When these very hard tubes are used the high tension transformer, such as the

Snook machine, will be found extremely useful. The control of the tubes when using the unidirectional current obtained from this type of transformer is a matter of comparative ease.

**The Interrupter.**—A condenser is necessary when the interrupter is of the mercury-jet type, as is also a condenser battery when the apparatus is used for many hours daily. The battery should be arranged so that it is convenient to quickly change from one set of condensers to another.

The *mercury jet interrupter* has already been described, see page 17, and little more need be added here. The best di-electric to employ is coal gas; a supply pipe with a tap being run from the main to the apparatus, to which a length of rubber tubing is attached, and this is carried to the inlet tap on the interrupter. Before turning on the main switch to the apparatus, the gas should be allowed



FIG. 189.—Mercury interrupter with gas di-electric. (Schall.)

to flow freely through the interrupter. It is a good practice to apply a light to the outlet tap, and allow the gas to burn for a few minutes in order to expel all air from the interior. It is important to see that the

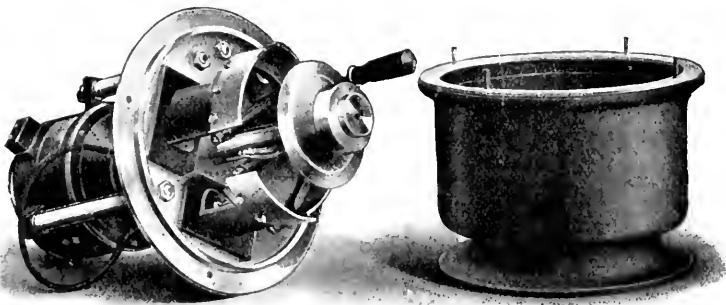

FIG. 190.—Mercury interrupter showing details.

interior of the interrupter is kept clean, and when a considerable amount of work has to be done it is well to thoroughly inspect the break at least twice a week and clean the jets out.



Some makers claim for their interrupter that cleaning is only necessary once in six months, but this is quite a mistake. Careful cleaning at short intervals facilitates harmonious working of apparatus.

Other forms of interrupters may be used, of these the best being the *electrolytic*. This break, if properly adjusted, will be found useful. It is the easiest of all interrupters to work with, requires very little cleaning, and hardly any attention beyond an occasional adjustment; it has the further advantage that the variations are greater. With an adjustable primary and two or more points in the interrupter, it gives a wide range of usefulness. When using very hard tubes it is necessary to get a relatively large current in the primary. This it is possible to obtain by using a thick platinum point. A tachymeter may also be used when desired. see Fig. 191.

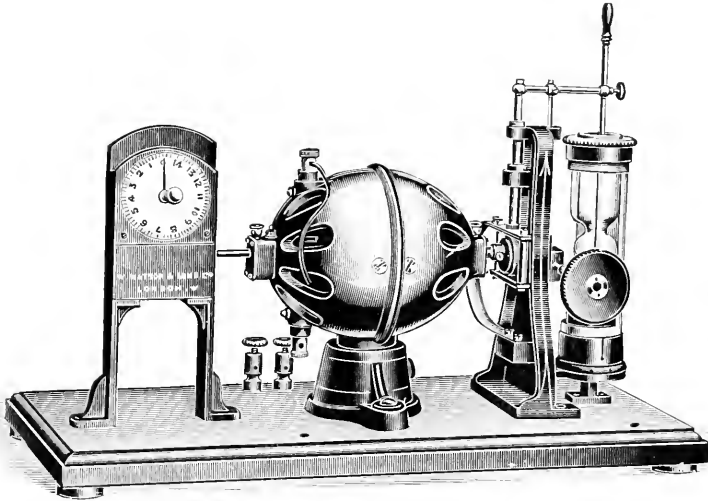

Fig. 191.—Dipping interrupter with revolution counter or tachymeter.

**Dipping Interrupter with Counter, for Regulating Therapeutic Doses.**—The interrupter illustrated above is designed chiefly for ringworm, but may be used for other therapeutic purposes of X-rays: it is arranged to give a dosage measured by a definite number of interruptions in the primary circuit. For this purpose a dipper mercury interrupter is employed, the turbine forms not being sufficiently definite, it being difficult to accurately register every interruption on the counter. The axle of the motor is directly connected with the counter, which is provided with an indicator and dial. The indicator is set to the number of interruptions the exposure is to consist of, and the interrupter switched on. When the indicator reaches zero the exposure is automatically terminated by the current being cut off by a relay switch. There is a timepiece on the circuit, and the exposures can be calculated by time, allowing for so many interruptions per minute.

The important thing in the management of all interrupters is to obtain

the maximum of current through a tube at a particular spark gap with the minimum of primary current. A little practice will soon enable the worker to adjust the points and primary to suit the particular tube in use.

**Valve Tubes.**—The employment of an electrolytic interrupter involves the use of valve tubes to cut out the inverse current, which is always present with this interrupter. Dr. Reginald Morton has called attention to an ingenious method of checking inverse current, described below.

#### The Morton Rectifier.

—This apparatus enables the operator to dispense with valve tubes. It may be used with currents up to 5 milliamperes. It should prove to be extremely useful in therapeutic work.

The aim of the apparatus is to provide a satisfactory means of eliminating inverse current without the use of valve tubes. The essential feature of the apparatus is a switch, which is mounted upon the shaft of the interrupter. It is in this connection similar to the mica disc valve designed by Mr. Leslie Miller, but in the Morton apparatus a rotary conductor is made use of on the same principle as the rectifier on a Snook machine. The amount of current which can be passed through the high-tension switch is practically unlimited, the only

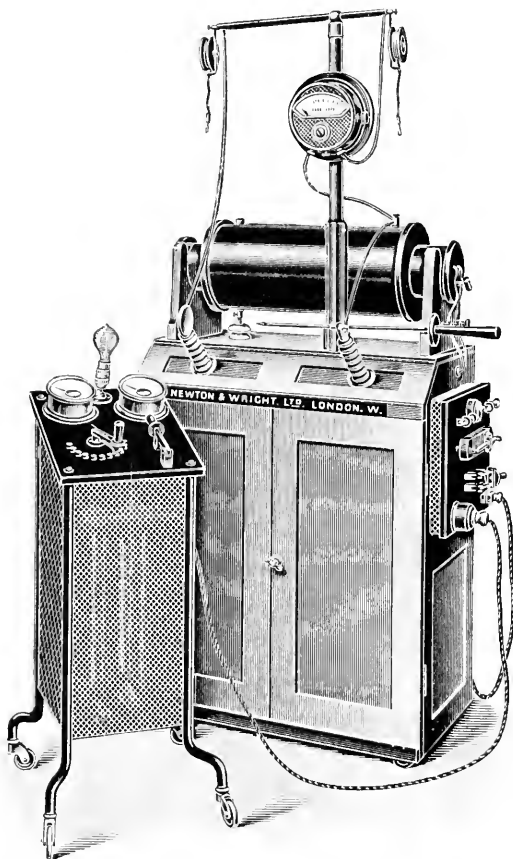

FIG. 192.—Morton rectifier fitted to a coil outfit, with control table.

factor at present limiting the output being the amount of energy which can be dealt with efficiently by a mercury break. The arrangement of the high-tension switch in relation to the mercury break is shown in Fig. 193, the respective parts by similar letters on the three figures. P P are the contacts through which the primary current passes to the coil when they are connected together by the revolving mercury jet. S S are the high-tension contacts connected in series with the X-ray tube circuit, the conductor C being so set, in relation to the interrupter, that the whole of the high-tension current passes through it, which is produced by the

break of the primary current. When the primary current is made, a long air-gap is interposed in the secondary circuit, which prevents the passage of the inverse discharge. The apparatus can be arranged to give quick or slow interruptions, the latter being particularly efficacious when used in therapeutic work, adjustments being provided to facilitate the use of either type of interruption. This arrangement appears to render the apparatus particularly applicable to therapeutic work of the intensive form, and the absence of all inverse current makes it possible to work without valve tubes. If this is borne out in practice the apparatus should prove itself to be of the greatest possible value to the radio-therapist. With most mercury breaks this inverse current is also present; so, whichever type of break is used it is well to have two or more valve tubes attached to the apparatus.

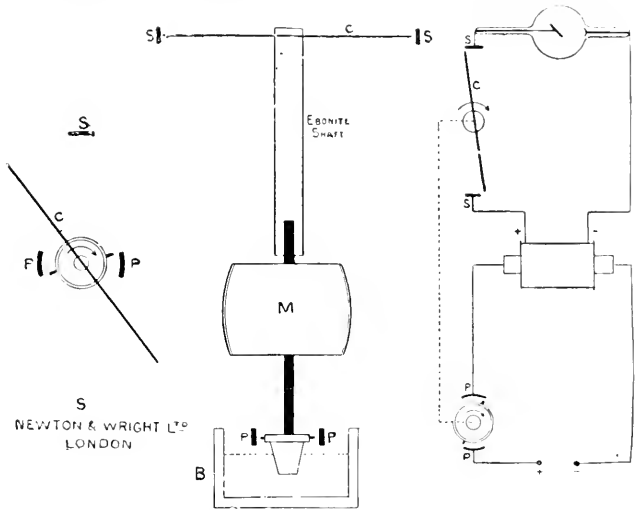

FIG. 193.—Diagram of connections for Morton rectifier.

An osmosis regulator attached to the valve tube, with a gas jet which can be regulated from a distance, is very useful.

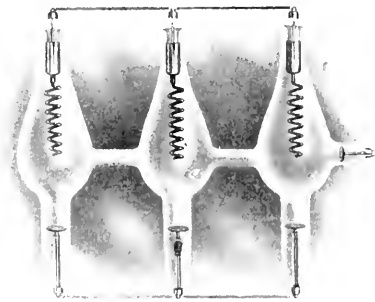

FIG. 191.—Triple valve tube (C. Andrews).

A triple valve tube will be sufficient to check a moderate amount of inverse current. This should have a regulating device attached to it. A good one, which is now being attached to a great many X-ray bulbs and valve tubes, is that introduced by Bauer (see Fig. 41, page 46). These tubes are capable of regulation from a distance, a length of rubber tubing being attached to the air valve.

while at the other end is a small hand-pump. By compressing the latter, a small quantity of air is allowed to pass into the interior of the tube. This lowers the vacuum. This is a good method for the regulation of X-ray and valve tubes, but requires careful manipulation to ensure efficient working.

The construction of a valve tube and the method of arranging one or

more in the circuit has been described in the section on radiography. What has been said there applies equally to the therapeutic outfit. With this as with all forms of regulators it is important that it should not be used too frequently or too vigorously. The vacuum is easily disturbed and the valve tube becomes too variable for easy control.

The most convenient mercury interrupter is probably a mercury jet interrupter. There are several which are all equally good. It should be possible to control the speed; a resistance should, therefore, be added for the control of the interrupter. Another resistance is necessary to regulate the amount of current passing through the primary.

Figs. 198 and 199 represent convenient arrangements for treatment outfit. The coil, spintermeter, valve tube, and milliamperemeter are placed on the top of an upright cabinet.

The leads from the secondary may be carried to a pair of insulated high-tension steel cables, from which the current is carried by means of spring cables to the tube holder.

On a suitable switchboard, the regulating devices are conveniently arranged. A mercury jet break is mounted on the base of the cabinet, while above it, if desired, a dipper break with an automatic tachymeter may be added to the outfit, this latter instrument being useful when it is necessary to record accurately the number of interruptions in a given exposure. It cannot, however, be relied on as an absolute measure of the dose; other methods must always be used as well, in order to get a check observation.

**The Rhythmeur Interrupter.**—This is a useful addition to the therapeutic outfit; it is very valuable for the deep treatment of tumours, when heavy currents require to be passed through hard tubes. It is a mechanical device by means of which the current is cut off for a fixed period of time, varying from one to four or more seconds. This allows the tube time to cool between the periods of activity.

*On the Use of Valve Tubes.*—This has been fully entered into in the radiographic section, but a brief reminder of the methods of connecting up the valve tubes will be useful here. The diagrams on p. 275 illustrate two methods of connecting the tubes. Sometimes, when a considerable amount of reverse current is present it may be necessary to put two or more valve tubes in a circuit. They can then be arranged on both negative and positive poles.

The tube used in X-ray therapy should be under the complete control of the operator. Any type of tube may be used, but it is important to have such control of it that the type of ray best suited to a particular case may be produced. It is not sufficient simply to turn on a switch with any tube and give a few minutes' exposure to the rays. That method sufficed in the days when little was known of the technique of X-ray treatment, but now we must be able so to manipulate the apparatus that results may be obtained with a degree of certainty.

The elaboration of the installation has been the necessary outcome of the experience of individual workers. Consequently, at the present time

we are still far removed from a standardisation of apparatus, tubes, and dosage. Before uniform results can be turned out this standardisation must become an established fact. It has been the aim of the writer to reduce, so far as is possible, all the installations under his care to a uniform standard.

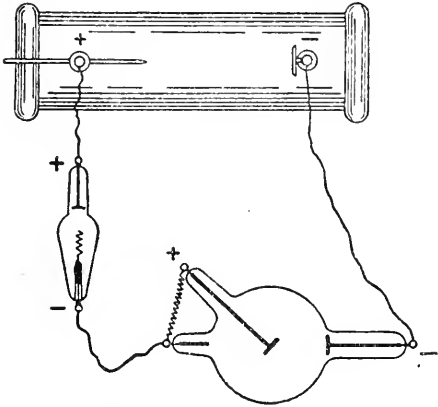

FIG. 195.—Method of connecting coil to valve tube and X-ray tube. Valve tube on positive pole (Siemens).

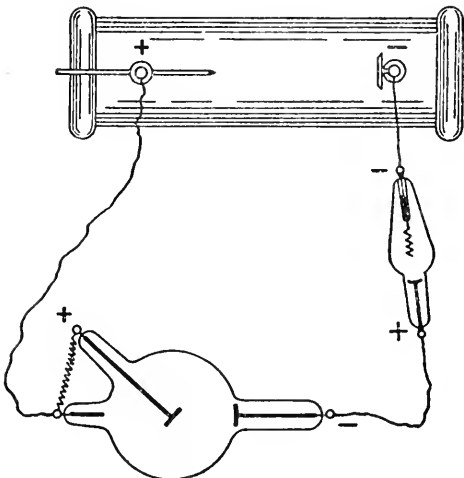

FIG. 196.—Method of connecting coil to tube. Valve tube on negative pole.

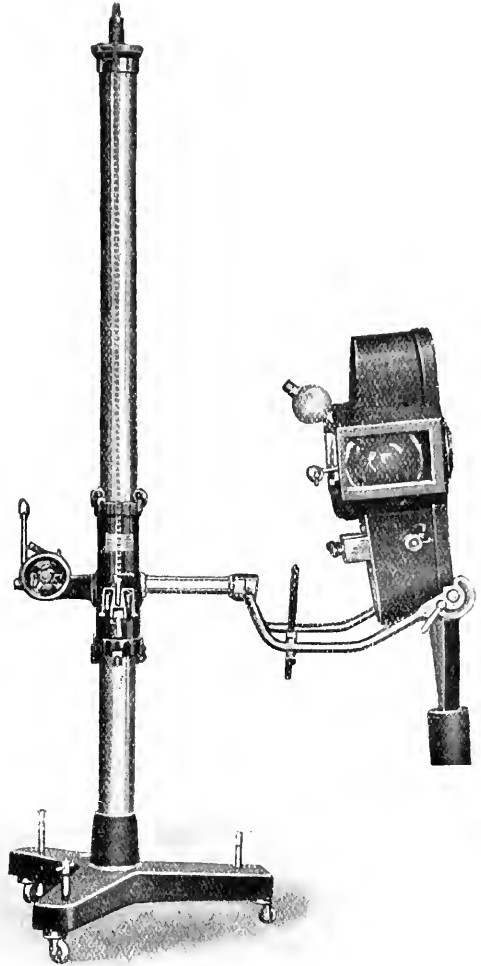

FIG. 197.—Tube stand for deep therapeutic work. (Schall.)

**The Therapeutic Tube Stand.**—Any simple stand will suffice for therapeutic work, but it must have good mechanical movements. One of the best is made by Gaiffé of Paris. The tube may be adjusted readily to any angle, and the movements are as perfect as mechanical ingenuity can make them. The only drawback to the stand is that only half of the tube is enclosed, and the lead glass is frequently not thick enough to ensure complete protection. The stand should have a number of extension tubes of various sizes, and should have also a tripod applicator for ringworm treatment.

The under aspect of the tube box should have a slot into which the filters can easily be placed, and a complete set of filters should go with each stand. The aluminium filters should range from  $\frac{1}{2}$  up to 3 mm. in thickness. In hospitals, especially, these parts should be easily sterilisable. The tube stand should also have a holder for the pastille.

Dr. Gauss of Freiburg has introduced a stand (Fig. 197) designed for tubes which are to be used with a very heavy current. It is so arranged that the distance of the tube from the surface of the body can readily be regulated and measured. In addition to this it has a number of good mechanical movements, which render its use a great acquisition to the operator. The tube box is protected by thick lead glass and lead rubber. This is necessary on account of the very hard tubes required for the treatment of deep-seated organs.

A treatment couch should move easily, and the top should be covered with leather or some sterilisable material. A hinged top on the couch is

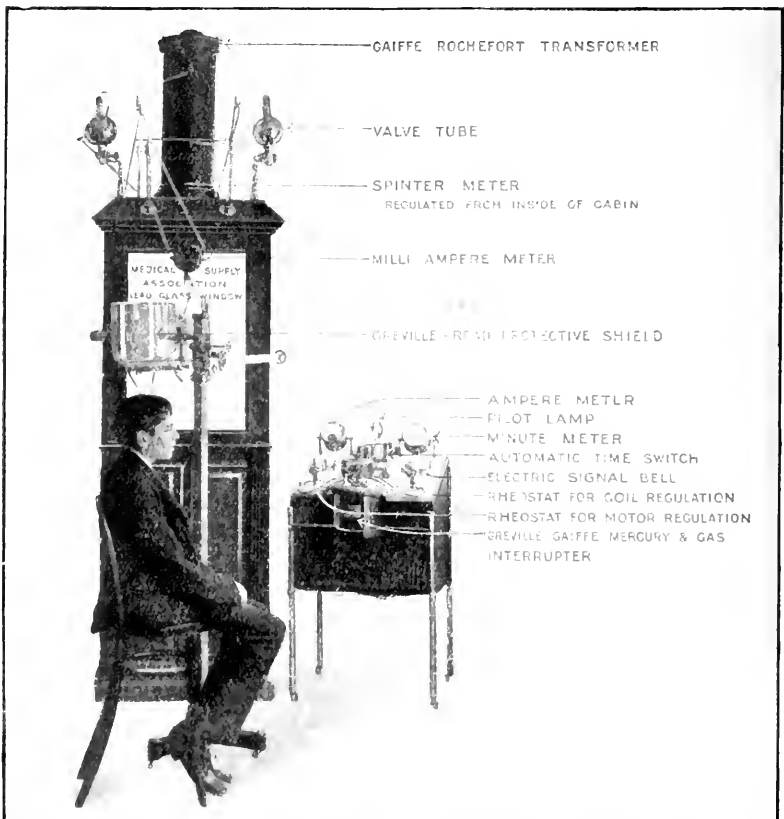

FIG. 195.—A convenient arrangement of apparatus for therapeutic work.

an advantage. A treatment chair is a valuable addition to the therapeutic department, and should have a movable head-rest, with side-clips

for fixing the head. It will be found most useful where children are being treated, as the head may be fixed without discomfort to the patient.

**Further Points on the Arrangement of Apparatus.**—It will be found to be a convenience to have all the parts of the apparatus which are likely to get out of order in an accessible position in the room; and all parts

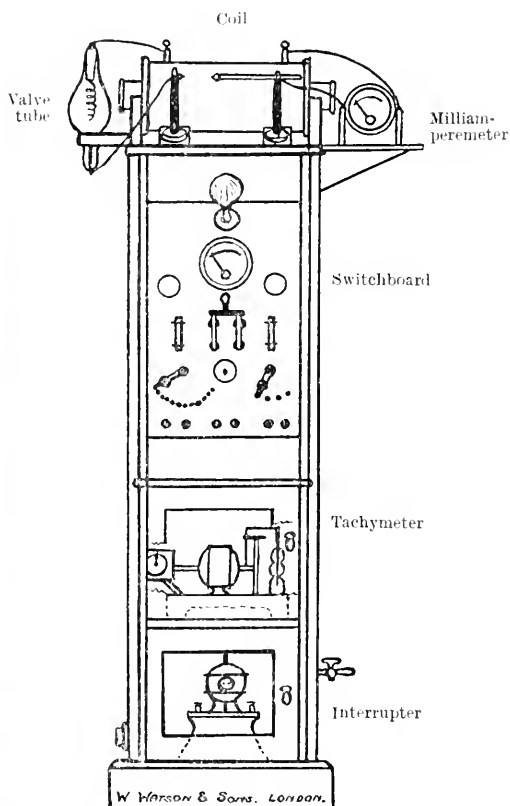
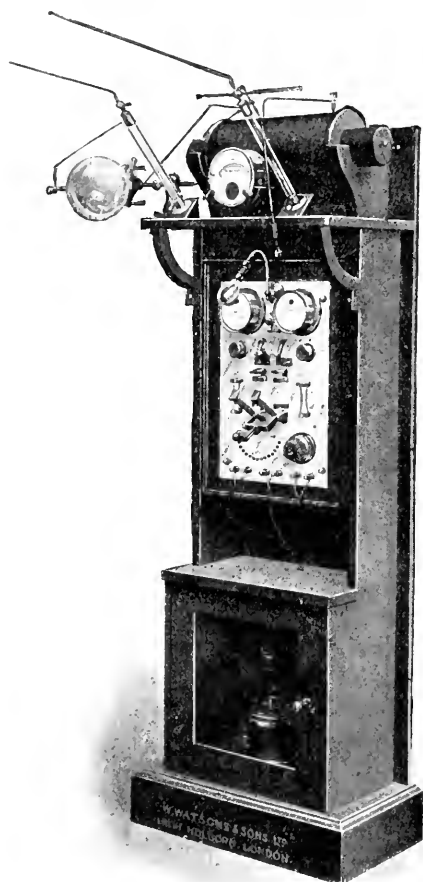

FIG. 199.—Apparatus arranged on an upright cabinet. FIG. 200.—Diagram to show arrangement of apparatus on an upright cabinet.

subject to variations should be readily controlled. It should be possible to darken the room if desired. This is not essential for therapeutic work, though it is a distinct advantage to be able to darken the room so as to observe how the tube is running.

The leads from the terminals of the coil may be connected to the tube by means of insulated or spring cables. It is convenient to have two steel wires carried across the room at a convenient height. These should be insulated at the points of insertion into the walls. Two spring cables on trolley wheels carry the current to the X-ray tube. The leads from the terminals of the coil

are connected to the overhead wires. This arrangement facilitates the adjustments of the tube stand and allows of a rapid change from one apparatus to another. Most of the newer tube stands are provided with an efficiently protected tube box. The tube is placed in the tube box or holder, and connected up to the coil and valve tubes. The anode of the coil is connected to the anode of the tube, and cathode to cathode (see Fig. 195). Valve tubes should be provided in all installations when a coil is used, and it will be an advantage to have an oscilloscope tube in the circuit. This should be placed at some distance from the coil if reliable observations are to be made. An oscilloscope in the near vicinity of a large coil often acts inefficiently owing to its proximity to the magnetic field of the coil.

**Testing the Apparatus before using for Treatment.**—The main switch should be turned on with a minimum current at first, and the tube observed as to style of running, colour, etc.; then the current may be gradually increased. The penetration of the tube is tested by a radiometer, or by the alternative spark-gap—a rough but very useful indication of the hardness of a tube. The qualimeter of Bauer may also be used for this purpose, and is to be preferred when many observations require to be made.

A note of the amperage in the primary should be made and of the current passing through the milliamperemeter. These are most important points on which the calculation of the exposure is based. There are, however, other factors which must be considered in detail.

## Methods used in Estimation of Dosage

At the very outset we are met with the difficulty of estimating even approximately the dosage. Many methods are employed, none of them perfect. Tubes vary from day to day in spite of the great improvements which have taken place of recent years. The various systems of measuring the X-ray dosage will be described in detail. At present there is no standardisation of dosage, and until this is obtained, it is best for an operator to understand thoroughly one good method and to work steadily with it. A knowledge of the others is useful, but it is hopeless to try to combine several different methods.

An erythema dose is one which causes slight erythema to appear within fifteen to twenty-one days. Four-fifths of an erythema dose will, in the majority of cases, cause the hair to fall out. This dose has been found to cause a change in the colour of certain chemical substances.

Two methods may be described: (1) The indirect, and (2) the direct. These two should always be used together, the indirect being a good check on the direct.

In the **Indirect Method** the milliamperemeter is used to measure, not the rays, but the quantity of current passing through the tube; and the number of milliamperes multiplied by the volts used gives the quantity of X-rays generated in the tube.



The quantity of X-rays received by the object depends on (a) the quantity of X-rays generated ; (b) the distance between the tube and the object ; (c) the time of the exposure ; (d) the sensitiveness of the object.

The reading of the milliamperemeter must therefore be supplemented by those other factors before we can estimate the dose received.

The distance has a great influence, because the intensity of the X-rays diminishes, like that of ordinary light, as the square of the distance increases. A strip exposed 40 cms. from the anticathode requires four times as many milliamperere seconds to assume tint  $5 \times$  as a strip exposed at a distance of 20 cm.

**Reverse Currents.**—The presence of reverse currents may cause an under-exposure, because milliamperemeters of the d'Arsonval type do not indicate alternating currents if both phases are of equal strength.

If one phase preponderates, as will be the case if the reverse current from the spark-coil becomes so strong that it can discharge through the tubes, the milliamperemeter indicates only the difference between the breaking and the closing current ; the stronger the reverse current the greater will be the error. With good modern coils there should be practically no reverse current with the weak or moderate currents, say up to 6 milliamperes, which are employed in the majority of exposures, but when currents of 10 milliamperes and more are employed, some reverse current begins to appear even with the best of coils.

If the coils are old or badly constructed, or if interrupters with high-frequencies are used, reverse currents may be present even when 1 milliampere only is used. The oscilloscope tubes, which indicate the presence and intensity of reverse currents, are not expensive, and can easily be inserted in the circuit with a milliamperemeter. They should be used if there is any doubt about the presence of reverse current, and if it exists it should be suppressed by means of a spark-gap, or by means of a valve tube, as otherwise the milliampere method will give wrong results.

Another error may arise if the glass of the tube is unusually thick. It is not likely that this will cause much difference, because the glass bulb absorbs the softest ray only. Another error may arise if the penetrating power of the tube changes during the exposure. The milliamperemeters are, however, the best and most convenient indicators of any such changes. The Bauer qualimeter also indicates these variations.

**The Direct Method.**—The total quantity of X-rays received by an object can be measured by various methods introduced by Holzkecht, Sabouraud, Kienböck, Bordier, Hampson, and others. The method most used in this country is that introduced by Sabouraud and Noiré. The principle is the same as that of several others, and depends upon the action of X-rays and similar agents upon a disc of barium platino cyanide, the same material that is used for the fluorescent screen. These discs and similar agents are known as chromo-radiometers, because of the change of colour which occurs when they are exposed to the action of rays.

The discs should be exposed on a thin sheet of metal at a distance from

the anticathode equal to half the distance between the anticathode and the skin of the patient; and they should be protected from the action of daylight. The change of colour takes place gradually under the action of X-rays, the green colour changing to a brown. The discs discolour in the same way whether exposed to an X-ray tube, an incandescent electric lamp, or to sunshine, or when heated in a flame from a spirit lamp.

When the pastilles are exposed to the X-rays, the apple-green colour changes gradually to red and red-brown, and by experiment the exact tint was found which the pastilles assumed after exposure to a dose which caused the hair to fall out. This is called tint B, and a tablet showing this colour is supplied with every booklet of Sabouraud pastilles. If an exposure of eight minutes caused the pastille to assume tint B, another two minutes' exposure will cause an erythema to appear after an interval. Where the dose is judged by the pastille alone the tint B in the booklet should always be used for pastilles used from the particular booklet. This is not necessary when Hampson's or Lovibond's radiometers are used.

These pastilles are not very sensitive, and to obtain a sufficiently great change in colour they have to be exposed at half the distance existing between the anticathode and the object, so that they receive four times the quantity of X-rays which the object receives. Nevertheless, quite large errors are often made by different observers in comparing these small shades of colour. The pastilles are sensitive to heat, so there should be a distance of at least 2 cm. between the tube and the pastille, or the heat of the glass tube may prematurely discolour the pastille. Daylight restores the colour to the pastilles. They must, therefore, be protected from bright light during the exposure, and compared with the standard tint in a light weak in actinic rays, *e.g.* the light of an incandescent lamp.

Great care must be exercised in estimating the degree of change in the colour, and it must be noted that a marked difference exists between the shade of colour of the disc when it is examined in daylight and when it is examined in artificial light. A serious error in dosage may easily be made if this difference is overlooked.

These pastilles have proved very useful in the estimation of dosage in the treatment of ringworm and superficial skin lesions, and they are almost universally used in the treatment of this first disease. A large measure of the success of the treatment of ringworm by X-rays depends upon the after treatment, and where the children cannot be under constant supervision it is very necessary to issue concise and definite instructions to the parents.

The several precautions which should be taken are dealt with later on. When using Sabouraud pastilles, a weak daylight is recommended, and for Holz knecht and Bordier pastilles the light of an incandescent lamp. When using these pastilles to measure dosage, a definite system of examination should be carried out in all cases. The time taken to change a pastille from the A to the B tint by the tube in use should be ascertained. Then

during an exposure of, say, ten minutes, the pastille should be examined at least three times.

The first examination should be at the end of four minutes. This will show whether the rays from the tube are acting on the pastille. If by any chance the tube is acting too quickly, a full dose may be given in less than half the time usually required, but this early examination makes it possible to avoid serious damage to the patient. Towards the end of the exposure the inspections should be more frequently made. Stress is laid upon this point here because recently in the experience of several workers vagaries of the tube undetected at the time have led to the administration of excessive doses in less than half the time usually taken by the tube to colour the pastille. These untoward results have also been obtained when to all appearances the tube was working properly and the pastille was under- rather than over-done. No system of measuring X-ray dosage is perfect, and whichever one is employed should always be checked by the indirect method. A Bauer qualimeter on the negative pole gives an approximate idea of the hardness of the tube. It is not absolute, but as a guide to the steadiness of the tube it is very valuable. The milliamperemeter records the current in the secondary circuit and approximately the amount of current passing through or around the tube. The alternate spark-gap also gives an indication of the hardness of the tube, and should be tested from time to time. Lastly, there is the tube itself. A careful watch kept upon it should enable the operator to judge of its condition. Experienced workers can tell the variations in hardness by the sound a tube makes when running. Some can tell approximately the exposure by the same means, *i.e.* appearances of the tube, sound, etc., but for an X-ray dosage, strict attention to detail and the careful watching of all the conditions should be insisted upon.

The pastilles should be compared immediately the exposure has been terminated, as the colour should settle the time of the exposure; if left for comparison till some time after, the pastille will be found to have faded. The same pastille should not be used more frequently than three or four times. Sabouraud pastilles show correctly when used with medium tubes, but with hard tubes there is a tendency to under-exposure, tint B being reached a little too early, and with soft tubes there is a tendency to over-expose, as tint B is reached a little too late.

In the booklet supplied by Messrs. Sabouraud and Noiré with the pastilles tint A represents the pastille before it is exposed to the X-rays. Tint B represents the same pastille after it has received exposure to the X-rays, corresponding to the maximum dosage which the human skin is able to receive without producing erythema, radiodermatitis, or a permanent alopecia.

**Holzkecht's Quantimeter.**—For this instrument, barium platino cyanide pastilles are also used, but they are compared with unexposed pastilles of the same material arranged under a celluloid film of red-brown colour, increasing gradually in intensity. By moving the exposed pastilles

along this film, the discoloration caused by  $\frac{1}{2}$ ,  $\frac{3}{4}$ , etc., of an erythema dose can be measured.

**Dr. Bordier's Chromo-radiometer.**—This chromo-radiometer depends, like Sabouraud's, on the discoloration of pastilles of barium platino cyanide, but the scale shows five different tints for comparison, instead of the single one of Sabouraud's instrument. Bordier's pastilles have to be attached to the skin of the patient. The pastilles should be compared with the scale or "Teinte B" by the light of a match, a candle, a benzine lamp, or other artificial light of slight actinic power. The distance between the pastilles and the glass wall of the tube should never be less than 2 cm., to prevent their being discoloured by the heat of the tube. The pastilles are most accurate when used with tubes of medium penetrating power. With soft tubes they tend to indicate a smaller dose, with hard tubes a larger dose than actually given.

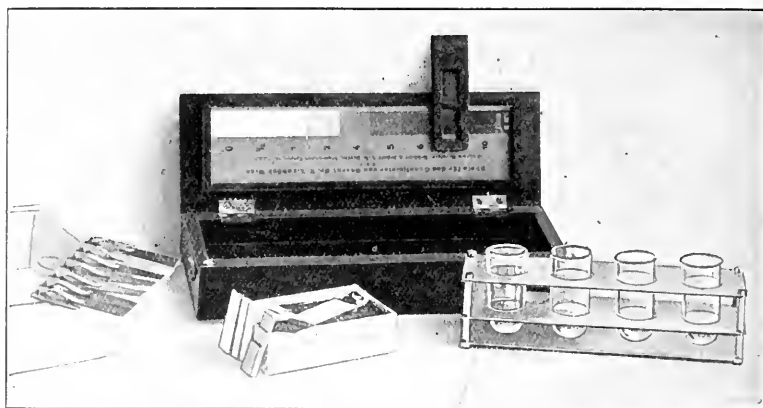

FIG. 201.—Complete Kienböck quantimeter. (Schall.)

**The Kienböck Quantimeter.**—This method is based on the discoloration of bromide of silver under the influence of X-rays. Compared with the chromo-radiometer of Holz knecht or Sabouraud, it has the advantage that it is more sensitive, gives more subdivisions, leaves a permanent record, and is cheaper. Its only disadvantage is that the results can only be read off after a strip of sensitive paper has been developed, a process which occupies one minute. There is no need to resort to a dark room, as with the help of a small light-tight box the development can be done in daylight in the consulting room.

The apparatus consists of :

1. Strips of bromide of silver paper measuring  $\frac{1}{2}$  inch by  $2\frac{1}{2}$  inches, enclosed in small light-tight envelopes. The envelopes bear a label to be filled up with the name of the patient, date, and duration of the exposure. Envelope and strip bear identical numbers.

2. A standard scale in wooden case, containing eight different tints of the colours which the bromide of silver will assume gradually under prolonged

influence of the X-rays. A runner with glass window slides along the scale, and the developed strips are placed into this frame.

3. A set of four test tubes of 2 inches diameter and 2 inches length, in small metal stands.

A convenient addition, when a dark room is not available, is a dark box, which enables the operator to develop the strips in the consulting room. This box has room for the stand holding the test tubes, in which development, washing, and fixing take place. It is, however, much better to develop the strips in a dark room.

*Arrangements for Exposure.*—One or several strips of the sensitive paper are placed on the part to be treated; they absorb practically no X-rays. The side of the envelope bearing the label must face the patient's skin. If the total dose is to be administered in several sittings, the same strip is always exposed again, so that the sum total of the rays reaching the patient will also reach the strip. If many sittings with short exposures are to be given, it is convenient to use more than one strip; one is left to record the total sum, and of the other, parts are cut off from time to time to make test developments.

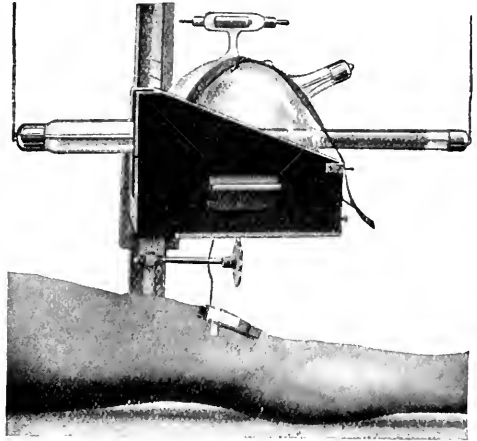

FIG. 202.—Arrangement of apparatus and paper when using Kienböck's method of estimating dosage.

The number of the strip, and other remarks, are immediately entered into the case book, where also the strip is stuck when it has been washed and dried.

*Development.*—In order to find out the quantity of X-rays which has been administered, the strip has to be developed.

The developer consists of two stock solutions, A and B, mixed in proper proportions with distilled water, and made up as follows:

A		B	
Distilled water	. . . 1000 c.c.	Distilled water	. . . 1000 c.c.
Sulphite of soda	. . . 150 grammes	Potassium carbonate	. . . 110 grammes
Metol (Hanff)	. . . 15 ..		

#### FIXING SOLUTION

Distilled water	. . . . .	1000 c.c.
Sulphite of soda	. . . . .	20 grammes
Tartaric acid	. . . . .	10 ..
Hyposulphite of soda	. . . . .	200 ..

Great care must be taken in preparing the solutions: it is essential that the bottles shall be absolutely clean, and that distilled water shall be

used throughout. The developer should never be used when it has become stale.

An alternative developer consists of a stock solution, made up as follows :

Metol . . . . .	1 gramme
Hydroquinone . . . . .	4 grammes
Sodii sulphite . . . . .	50 „
Carbonate . . . . .	50 „
10 per cent solution of potassium bromide . . . . .	4 c.c.
Distilled water . . . . .	500 c.c.

The fixing solution is made up as follows :

Hypo . . . . .	400 grammes
Water . . . . .	1000 c.c.
Potassium meta-bisulphite . . . . .	25 grammes

Each box of strips is furnished with a set of instructions regarding the duration of development, and these must be carefully observed.

It is not always possible to make succeeding batches of strips of exactly the same degree of sensitiveness; therefore each new batch is carefully tested, and if necessary a new scale of tints is prepared. Each strip is marked with a letter, and must only be compared with a scale bearing the same letter.

The first of the four test tubes is filled with the developer mentioned above, the second is filled with water, the third with fixing solution, and the fourth again with water. The strips are taken out of the envelope either in



FIG. 203. —Developing the strips.

the dark room or in the dark box mentioned above, and are immersed in the developer for a certain time, as stated on the instructions with the strips. The strip must be kept in motion while in the developer. The same developer can be used for several strips, but it deteriorates gradually in contact with air. As in photography, great care must be taken that

the developer is not contaminated with hypo, and it must be at the temperature stated on the instructions (18° C.), because too cold a developer produces far too light a tint. After development, the strip is washed for a few seconds in the second glass, and transferred into the third glass containing the fixing solution. It ought to remain in this not less than a minute, but if it remains longer no harm is done. Then it is rinsed in the fourth glass, and is ready for comparison with the standard scale. (It need not be

dry for this purpose.) To leave a permanent record, the strip has to be washed like any print for about half an hour in several changes of water. Several strips may be developed or fixed simultaneously by using a large enough vessel.

The *Standard Scale* consists of nine different tints, marked 0,  $\frac{1}{2}$ , 1, 2, 3, 4, 5, 7, 10. The tint marked 1 is to be considered the unit, and is denoted by 1 *x*. It is half the value of the dose required to produce one unit in the Holz knecht Chromo-radiometer, and one-tenth of the Sabouraud-Noiré Tint B dose.

We therefore have :

$$10 x \text{ (Kienböck)} = 5 \text{ H (Holz knecht)} = 1 \text{ B (Sabouraud-Noiré)}.$$

If it is intended to administer the maximum dose in one sitting, it will be a convenience to expose two strips of paper simultaneously. When, measuring the current passing through the tubes with a suitable milliamperemeter or judging the degree of fluorescence by experience, it is found that the maximum dose desired has been nearly reached, the exposure is interrupted for a few minutes to develop one strip and compare it with the

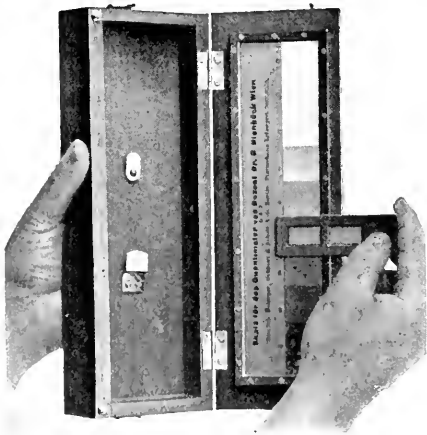

FIG. 204.—Comparing the wet strip with the standard scale, using the slide.

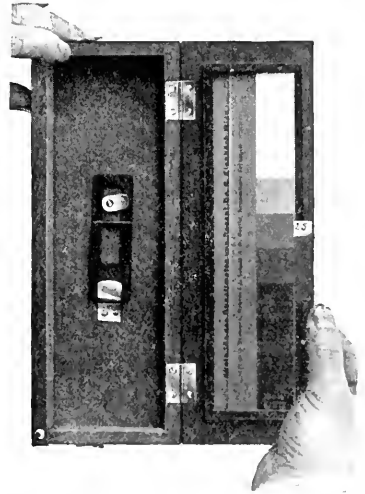

FIG. 205.—Comparison of the dry strip without the slide.

standard scale. If it took ten minutes to produce tint No. 5, then it will require another two minutes to bring it to tint No. 6; or if it took nine minutes to impart to the strip the colour of tint No. 6, it will take another six minutes' exposure to bring it to a colour similar to tint No. 10 (provided that the condition of the tube has not altered materially).

As it is not possible to read the value of the dose directly from the quantimeter strip during the irradiation, it is advisable to measure the dose at the same time by observing the milliamperemeter, and timing the duration with a watch, or it may be checked by using at the half-distance a Sabouraud pastille. A second pastille may be placed on the skin and checked by means of a Hampson or Lovibond radiometer.

If it is desired to ascertain the quantity of X-rays which have reached a certain depth, a piece of aluminium 1 mm. thick is laid on part of the strip. It has been found that this absorbs as much of the X-rays as a layer 1 cm. thick of skin, fat, and muscles will absorb. In such a case the developed strip will show two different tints: the darker one indicates the quantity of rays received by the surface of the skin; the lighter tint records the quantity of rays which have penetrated to a depth of 1 cm. below the skin. Strips of aluminium are supplied also which help to find the effect produced at 1, 2, or 3 cm. depth. If the effect is desired on the skin only, it is advisable to use medium tubes, No. 8 Wehnelt; if deeper lying parts have to be treated, it is necessary to take tubes No. 10 or 11 Wehnelt. It is an advantage to bring the tubes rather close to the skin (distance 8 to 18 cm.): for treating ringworm, 15 cm.; for treating ovaries, 18 to 25 cm.

It is, however, often necessary nowadays to give doses far larger than 10 x in a single sitting for the treatment of fibroids or malignant disease. As

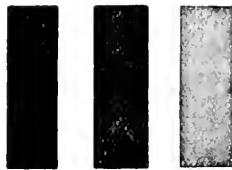

FIG. 206. — Plain strips, exposed and developed.

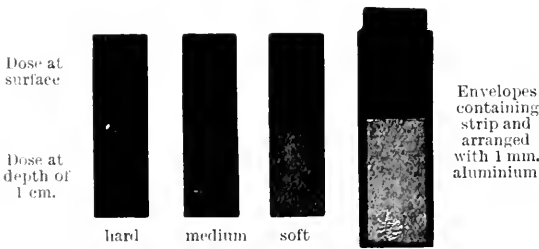

FIG. 207. — Strips exposed with 1 mm. aluminium and developed.

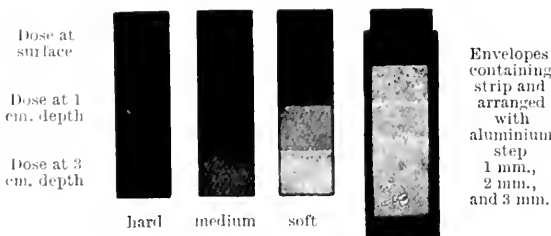

FIG. 208. — Strips exposed with aluminium ladder and developed.

the strips would become far too dark for comparative readings to be made under these circumstances, a second scale has been prepared, in which tints are shown which are obtained on strips exposed under a block of aluminium 10 mm. thick. In this way the action on the strip is lessened and the latter does not become so dark, although large doses are given. Quantities up to 30 or 40 x can be conveniently estimated. The comparison, development, etc., of the strips is exactly the same as if the 10 mm. aluminium were not used. The dose which the strip then shows is that which has been applied at the surface, and not, as is sometimes assumed, that which has reached 10 cm. depth.

The strips should be compared with the standard scale and a record kept of all exposures given, with the total dose for each complete



treatment. The method of recording these data will vary with each operation. A record sheet should be reserved for each patient, and all particulars of treatment entered on it. A portion of the developed paper may be

Name J. B. Very Medical Attendant M. Medico  
 Address City Exchange 8, Hospital Place

Record of X Ray Exposures.

Date	Hardness of Tube	Exposure		Amp	Ma	Filter	Area	Paper and Value on Scale	Remarks
		Min	Sec.						
9.3.14	7½	10		5	3½	Chamois 3mm	1	10+	
	8½	10		5	2		2	10+	
12.3.14	9	15		4	1½		3	No paper	
12.3.14	"	"		"	"		4	No paper.	
18.3.14	8	"		5	3		2	10	
"	9	"		4	1		2	8	
25.3.14	9	15		5	2½		3	5	
-	9	15		5	2		3	4	
30.3.14	9	15		5	2		3	4	
"	9	15		5	3		3	4	
6.4.14	9	-		4	2		1 back.	5	
"	9	-		2	1½		2 back.	4	Brush not working well.
15.4.14	7-8	10		4-4½	2-2½		1	5	
	7	10		4½	2½		2	5	
	9	15		5	2	Dev. wrong.	5	2	Improving.
				6	3		6	2	
6.5.14	9	15		5	2½	3mm.	5	6	
	6½	20		4½	2		6	6	
19.5.14	9	15		6	3½		3	8	
"	"	-		"	"		4	8	
Total									

FIG. 209.—Chart of X-ray exposures, to show method used in recording dosage by Kienböck's method.

Chamois is used as a secondary filter, and the figures in that column refer to the thickness of aluminium used.

arranged opposite each dose, and its numerical value placed alongside. This enables the operator to calculate rapidly the total of the exposures. All the other data of exposure should also be recorded. Fig. 209 illustrates a good method used for recording the dosage.

**The Ionto Quantimeter.**—This instrument has been designed by Dr. Szillard of Paris. An electrometer and a small static machine to charge it are enclosed in a small case, and a needle moving over a scale indicates the degree of the charge. A flexible rubber tube, which encloses a conductor,

leads from the electrometer to a small ionising chamber, which contains one electrode connected with the electrometer, and a second one connected to earth.

It is necessary that the insulation should be perfect, so that surface leakage owing to dampness cannot take place. When the X-rays reach this ionising chamber the electrometer begins to discharge, and the index of the needle moves from 0 towards 10.

The division of the scale has been calibrated to agree with the Kienböck quantimeter. When the needle reaches 10, the ionising chamber, which can be exposed on the skin of the patient, has received a full erythema dose. The instrument is so sensitive that half an  $x$ , *i.e.* the twentieth part of an erythema dose, can be measured. The degree of ionisation varies with the penetrating power, and the instrument can be calibrated for various degrees of it by placing diaphragms of lead over the ionisation chamber, so that the area exposed to the influence of the X-rays can be made larger or smaller. The instrument is new, and its practical value has yet to be proved. In theory it is certainly good.

**Lovibond's Tintometer** (perfected by Dr. Dudley Corbett) provides a very accurate method of estimating the degree of coloration of the Sabouraud-

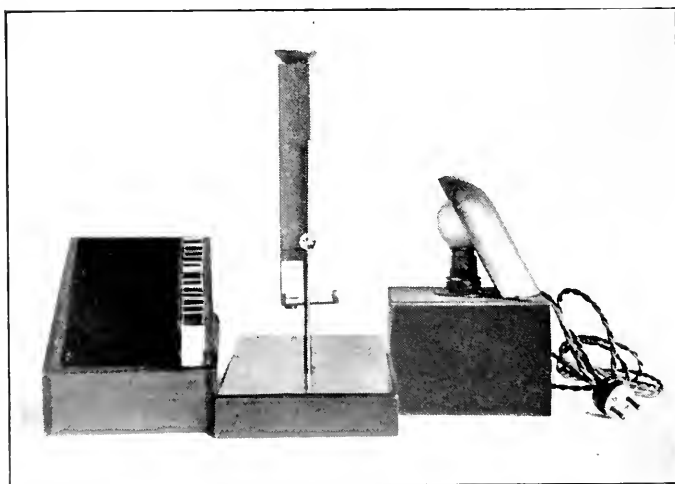

FIG. 210.—Lovibond's tintometer, adapted and standardised for the accurate measurement of the colour-changes in the Sabouraud-Noiré pastille by Dr. Dudley Corbett. (The Tintometer, Ltd.)

Noiré pastille. The apparatus consists of a tube or oblong viewing box, divided into two by a vertical partition, so that on looking through the eye-piece against the background two small white circles are seen. At the distant end of the box are frames provided for the insertion of the glass standards; on the right for the colour tints, and on the left for a neutral tint if required. The use of the latter will be explained below. The background is composed of pure white standard paper. In the background support is

cut a shallow groove or a hole for the pastille holder, depending on the type used, so that the pastille can be examined without removal from its holder. The tint of the pastille is thus compared with the standard inserted. It is possible to get such an exact match in tint that it is impossible to say on which side the pastille was situated. The advantages of this radiometer over others, where the Sabouraud pastille is employed, are :

(1) The colour standards are kept constant and invariable in tint, are easily kept clean, and do not fade. The smaller differences between the fractional doses are readily appreciated.

(2) They have all been verified experimentally in tinea work, and any fractional or multiple dose can be standardised.

(3) There is provision of a separate series for daylight and standard artificial light. A series could be worked out for any constant source of light if required.

The standards are composed of tinted glass and can be supplied for any fractional dose, from the unexposed pastille, or Tint A of Sabouraud, up to 2 B; in other words, the standard for any dose up to 10 H, or 20 X, can be supplied in an absolutely accurate and permanent form. It has been thought desirable to retain the symbol B to represent the erythema dose, for doses in therapeutic work are usually spoken of in terms of "B" in this country.

The doses in common use are those for :

A	$\frac{1}{2}$ B	$1\frac{1}{5}$ B
$\frac{1}{4}$ B	$\frac{2}{3}$ B	2 B
$\frac{1}{3}$ B	$\frac{1}{4}$ B	

But standards for any intermediate dose can be made to order.

There are also neutral-tint glasses for use when measuring the unexposed pastille and the  $\frac{1}{4}$  and  $\frac{1}{3}$  B in *daylight*. Parts of a set can be obtained if desired.

This instrument is the result of an enquiry into the colour changes occurring in the Sabouraud-Noiré pastille when exposed to X-rays. The standards are invariable and do not fade. Equal accuracy can be obtained by white daylight or by electric light. The standard electric light is that from an 8 e.p. carbon filament lamp, with frosted glass and in good condition. Failing a carbon filament lamp, a low-power metal filament lamp with frosted glass may be used, but the results are better and more accurate with the carbon filament lamp which was used for the experimental work. The pastille should be about 6 inches away from the lamp; care should be taken that no shadows are thrown upon it. The pastille should be examined in its holder. The exact dimensions of the holder, as well as that of the pastille in use, should be given, or preferably a specimen submitted to be fitted to the instrument. The area of pastille exposed to the action of the rays should be of such a size that on looking down the instrument *none of the unchanged green colour* should be visible. Therefore those holders that only expose half of the pastille should not be used. The actual aperture which

controls the amount of pastille exposed to view can be varied to suit requirements.

The examination should be made rapidly, as the pastille fades even in electric light.

*The Epilation Dose.*—When new pastilles are used, the standard for 1 B allows a 20 per cent margin of error on either side, *i.e.*  $\frac{4}{5}$  nearly always epilates and  $1\frac{1}{5}$  B is nearly the absolute limit of safety for unfiltered rays. For quite accurate work new pastilles should always be used. The tint of a used and bleached pastille can always be compared with the standard; if it is definitely more yellow than this it should be discarded in any case. The *daylight*

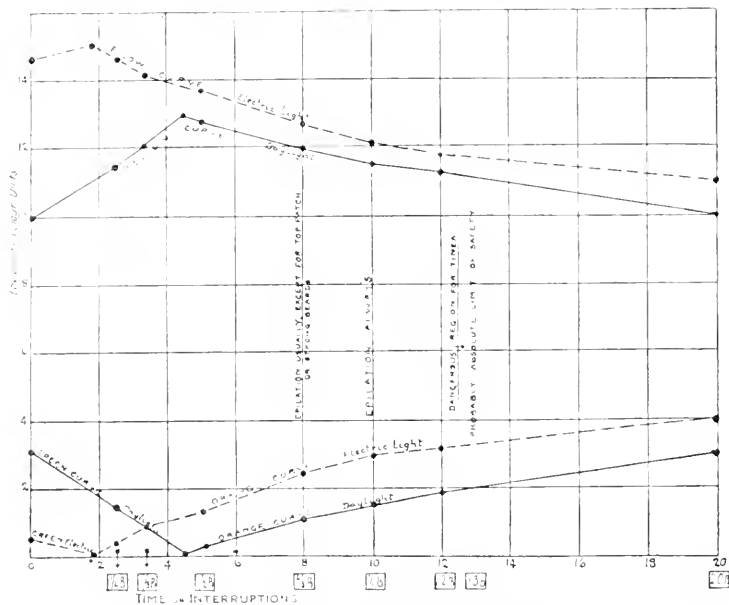

FIG. 211.—Curves showing colour developed by Sabouraud's pastille when exposed to unfiltered X-rays in measured doses.

standards for the unexposed pastille and for  $\frac{1}{4}$  and  $\frac{1}{3}$  B require the additional use of neutral-tint glasses if the colours are to be matched exactly, otherwise they are brighter than standard, due to the white light reflected. This brightness is dulled by the interposition of a standard neutral-tint glass. The grade of neutral-tint varies very slightly with the amount of varnish on the pastille. On an average the neutral-tints required are 1.5 for the unexposed pastille, 0.4 for  $\frac{1}{4}$  B, and 0.2 for  $\frac{1}{3}$  B. For higher doses no neutral tints are necessary. When measuring by electric light a neutral tint is only required for the unexposed pastille standard, and this is usually about .50.

**Hampson's Radiometer.**—This is a new radiometer designed for the purpose of reducing the length of time which is necessary before the full dose may be given when employing the Sabouraud-Noiré pastilles.

It consists of a series of twenty-five very carefully graded tints, which

represent the colour assumed by a pastille of barium platino cyanide under the action of X-rays.

The initial or zero tint is the colour of the unexposed salt, and the sixteenth change represents the brown shade of colour equivalent to the maximum or B tint of a pastille as employed by Dr. Sabouraud.

The radiometer consists of these tints arranged upon a circular card, the latter being enclosed in an outer case. This has a small aperture cut in it, through which the tints can be successively viewed one at a time, and the aperture is so shaped that the sensitive pastille can be placed in close proximity to the tint, the latter being rotated by the thumb until an exact match in colour has been obtained.

Another small opening exposes to view a series of numbers, ranging from 0 to 24, whereby the tints can be identified. The whole is covered in black cloth.

Tints are so arranged that for exact matching they shall be viewed by artificial light as obtained from an ordinary incandescent carbon lamp. In hospital practice this is found to be the most convenient, as artificial light is frequently employed, and there is nearly always a pilot lamp on the switchboard by which the tints may be accurately gauged.

The radiometer is so sensitive that it is possible to measure with accuracy the pastille tint when it has not become nearly such a dark colour as in the case of the Sabouraud method, and Dr. Hampson reduces by half the exposure time for an epilation dose, by bringing his patients nearer to the X-ray tube than was hitherto permissible in view of the danger which might accrue from inaccurate judgment of the colours.

When employing this method it is necessary to place the pastille on the patient's skin, and a full epilation dose is obtained when the pastille has turned four divisions of the scale. When the sensitive pastilles are exposed to daylight, it is known that they return to a great extent (although not absolutely) to their initial colour, and this appliance provides a means of using a pastille safely in this condition, as it is only necessary to place it in the radiometer before use and find the number which indicates its colour, and the full dose will then be obtained when the pastille has turned to another tint nearly four stages darker.



FIG. 212.—Hampson radiometer.  
(Newton and Wright.)

It should be noted that, since the darker shades are not so readily distinguishable as the lighter ones, it is not advisable to use the same pastille more than four times in succession. Also that the colour-change of the pastille is not exactly even, the earlier stages being slower in proportion to the X-rays received ; in each exposure of a fresh pastille therefore it is better to stop a little short of the four-stage tint.

Further, the delicate gradations of tint available in this instrument have made manifest the widely different interpretations put by different observers on the same shade of colour. It is, therefore, wise for operators who have not worked long enough with the new instrument to be sure of their own interpretation of the finer shades, to stop short of what appear to be the four complete grades in giving the epilation dose.

### The Use of Filters

The question of filtration is an important one, and a diversity of opinion exists as to the value of filters. So important is this question that a great deal of discussion has taken place on the matter, but as yet no standard filter has been agreed to. Some authorities are content to filter through boiler felt, tungstate of calcium on lint, etc. Others use aluminium or leather. The valuable work done on this question by Gauss and Lembeke of Freiburg has seemed to prove that aluminium, when properly used, is undoubtedly the best of all the filters. Felt, if used of sufficient thickness, is an excellent filter, and in the hands of some may be sufficient.

The position of the filter in relation to the patient and the X-ray tube is a point of the greatest importance. If it is close to the skin it must be earthed. A layer of some material, such as lint, leather, or paper, must be placed between the filter and the skin in order to absorb the secondary radiations which are largely given off when aluminium is struck by X-rays. It is a better plan to place the filter at the half distance between the anti-cathode and the surface of the body, and even at this distance the skin should be protected by felt or wash leather. A number of filters of varying thicknesses should be provided—from  $\frac{1}{2}$  mm. to 2 or 3 mm. form a good set. These are used according to the object aimed at and the frequency of the exposures.

After an extensive use of these filters the opinion has been arrived at that no ill effects directly attributable to the secondary radiations from aluminium have ever been obtained. Reactions have occurred, but they have readily been traced to the frequency and length of the exposures, and not to secondary radiations.

In the treatment of cancer by X-rays the writer is convinced that the results obtained when using aluminium filters have been better than when boiler felt or other materials were used. By gradually increasing the thickness of the filter, it has been possible to give larger doses, and those more frequently, than would have been possible without their use. He

attributes this improvement in results unreservedly to the help afforded by these filters, and to the employment of very hard tubes, which are so generally used when filters are employed.

It is remarkable to note how often the same area may be treated without producing any marked reaction. When the reaction is not very great, treatment can be steadily continued with an increasing thickness of filters, whereas without their use it would have to be suspended for weeks and valuable time would be lost.

The treatment may be continued even in the presence of marked reaction if the healthy skin can be protected by thick layers of lead or lead rubber, leaving only the diseased areas exposed to the treatment.

**Filter Equivalents.**—Dr. R. W. A. Salmond, working in the Research Laboratory of the Cancer Hospital, conducted an exhaustive investigation into the value of the various substances used for filtration of X-rays. His results show a remarkable uniformity, and will be of the greatest use to the radiotherapist. A tabulated list of his conclusions is given below :

#### FILTRATION EQUIVALENTS FOR HARD THERAPEUTIC X-RAY TUBES

Aluminium.	Pure Compressed Paper. <sup>1</sup>	Tanned Leather. <sup>2</sup>	Chamois Leather.	Boiler Felt.	Tungsten Lint. <sup>3</sup>	Lead Acetate Lint. <sup>4</sup>
·5 mm.	3 mm.	3 mm.	10 mm.	13 mm.	2 layers	1 layer
1 ..	7 ..	7 ..	18 ..	30 ..	4 ..	2 layers
2 ..	13 ..	13 ..	35 ..	67 ..	8 ..	4 ..
3 ..	17 ..	16 ..	59 ..	97 ..	12 ..	6 ..

**The Selection of the Filter.**—This largely depends upon the object of the treatment. In superficial lesions a  $\frac{1}{2}$  mm. filter of aluminium will suffice. When treatment has to be continued over a long period, at frequent intervals, then it is well to use a filter 1 mm. thick for several weeks, and gradually increase up to 3 mm. The choice of filter in malignant disease is fully discussed in the chapter on the treatment of malignant disease. In the treatment of myoma uteri by the Freiburg technique the filter is 3 mm. thick. This was found by Gauss to be the most useful one, and it affords ample protection when many ports of entry are employed. In these cases great care must be exercised to prevent overlapping of the areas.

**Additional Filters.**—In addition to the metal filters, a number of thick felt pads and a good supply of chamois leather will be found useful. A supply of thick lead sheets should be at hand. Lead rubber is also very useful for protecting the skin surrounding the area to be treated; pieces can be cut to the desired shape and size, and as they are easily sterilised they may be used again for the same patient.

<sup>1</sup> Known as London board.

<sup>2</sup> As used for repairing boots.

<sup>3</sup> Average hospital quality of lint thoroughly soaked in a saturated solution of sodium tungstate, and allowed to dry in the air.

<sup>4</sup> Same similarly treated with lead acetate.

## The Choice of the X-Ray Therapeutic Tube

This is a most important matter. A great variety of tubes are in use, and each type of tube has its enthusiastic advocates. The earlier therapeutic tubes were of small diameter, and were exhausted to work with a small amount

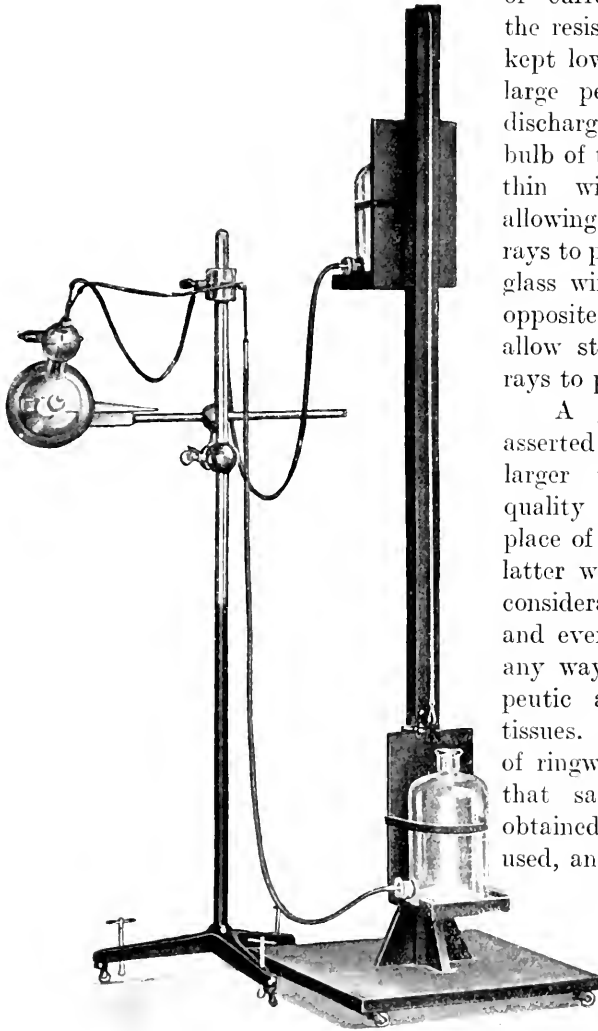

FIG. 213.—Diagram to illustrate a method of circulating water to the anti-cathode of a tube. (Schall.)

The tube is shown unprotected. This would not occur in actual practice.

of current in the secondary, the resistance of the tube being kept low in order to ensure a large percentage of soft rays discharging from the tube. The bulb of the tube was made very thin with the intention of allowing as many of the soft rays to pass as possible. Special glass windows were introduced opposite the anti-cathode to allow still further the softest rays to pass.

A gradual tendency has asserted itself of late to use the larger tubes, and a harder quality of ray has taken the place of the very soft one. The latter was found to produce a considerable degree of reaction and even dermatitis without in any way increasing the therapeutic action on the deeper tissues. Even in the treatment of ringworm it has been found that satisfactory results are obtained when a hard tube is used, and the reaction obtained

is much less than that from a soft tube. And in this disease the use of  $\frac{1}{2}$  mm. filter of aluminium gives quite good results, with hardly

any reaction, and only slight delay in the epilation. So that even for the most superficial conditions we may have to treat, a hard ray can be employed and a filter used. The Coolidge tube promises to be of great value in therapeutics. With its ready adjustment of quality



of ray emitted from the tube it should be possible to select the proper degree of hardness at will, and arrange the tube to produce it for

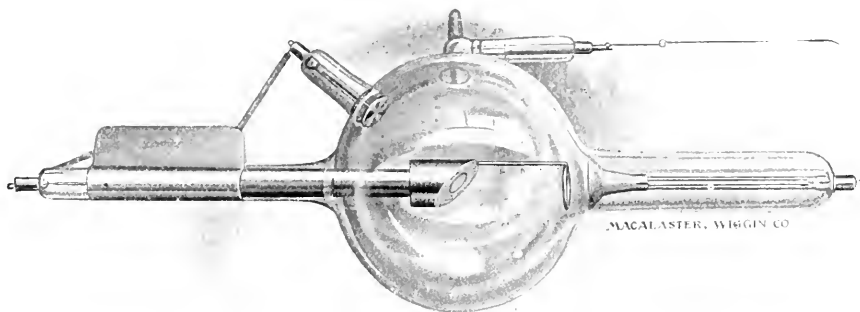

FIG. 214.—Macalaster Wiggin X-ray tube.

an unlimited time. The new tube makes the reproduction of precisely similar rays at a subsequent exposure possible. Many of the difficulties at present existent in the control of X-ray tubes should disappear if this

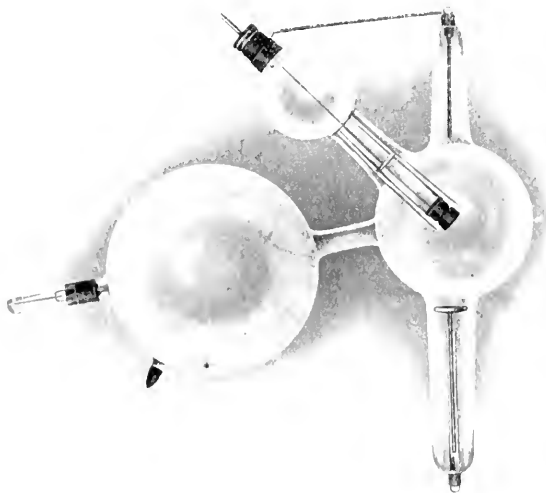

FIG. 215.—Penetrans tube. (C. Andrews.)

tube answers to its expectations. For superficial work, such as treatment of skin diseases and particularly ringworm, a small tube will do excellent work.

It must be kept for such work, and should never be allowed to pass more than 1 milliamperes of current. When carefully used it is possible to get a great deal of work from these small tubes. For all deep work, where great penetration is required, the larger tubes are absolutely necessary. These may be of any type so long as they meet the requirements of the cases treated. The water-cooled is a good example of the tube suitable for deep therapy. There are two varieties of this tube :

(1) The Penetrans, a tube with a small bulb. Attached to it is a larger accessory bulb, which favours the maintenance of the vacuum (see Fig. 215). This tube makes it possible to get closer to the skin surface with the anti-cathode. The tube is fitted with an osmosis regulator.

(2) The ordinary water-cooled tube is also very useful. Both of these tubes may be fitted with a circulating flow of cold water by means of a special apparatus.

Of the later types of tubes which are made to stand heavy currents for long periods, the radiator tube of Cossar or Gundelach and the Macalaster Wiggin are most useful (Fig. 214). Dessaeur (Fig. 216) has recently manu-

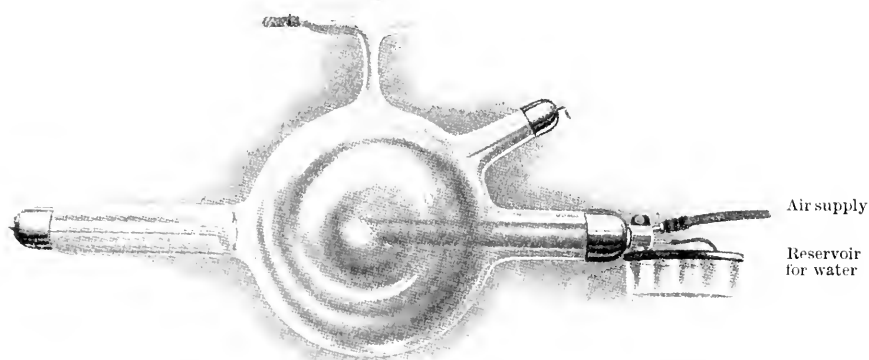

FIG. 216.—Dessaeur therapeutic tube.

factured a tube which emits a particularly hard ray, and which he claims to be approximately as good as the Gamma-ray of radium. The tube is fitted with a spray which impinges a stream of water vapour upon the back of the anti-cathode. If this tube possesses a fraction of the power which is claimed for it, it should be a good tube for deep therapeutic work. But in all probability the Coolidge tube will be the main stand-by of the radio-therapist in the future.

The routine practice of the writer is to employ large tubes for practically all therapeutic purposes. The advantages claimed for these tubes of greater diameter are :

(1) The tube maintains its vacuum much longer than the smaller one, and is not so easily thrown out of adjustment.

(2) It may be used with much heavier currents and for a longer time. When thoroughly seasoned, a large tube may be run for hours without showing any appreciable variation in hardness. This is most important when large areas require treatment or when deep-seated tissues have to be radiated.

*Methods used for cooling the X-ray Tube.*—In view of the increasing importance of X-ray therapeutics, and the increased calls that are consequently made upon the X-ray tube, all accessory methods of regulation and cooling must be carefully considered. Of the cooling devices the two methods most likely to be employed are :

(1) The water-cooled tube, with a constant circulation of water to the anti-cathode.

(2) The air-cooled tube, where both the cathode and the anti-cathode are cooled by a supply of air obtained from a motor-driven pump.

By means of these cooling devices and the use of a rhythmic interrupter, it is possible to get therapeutic effects upon deep-seated tissues by means of greatly increased dosage, both of time and hardness of ray. Five and six milliamperes may be passed through a hard tube for a considerable period.

The water-cooled tube is the most useful. With care in usage, this tube will answer to all the requirements of present-day therapeutics. It is very important that the tube should be gradually seasoned before it is subjected to a severe test. If this is done, large currents may be passed through it for long periods and the hardness of the tube be maintained. Air-cooled tubes are useful in places where a large amount of work has to be done. These, again, must be seasoned before they are severely tested. Of radiator tubes, the Cyclops is one of the best for therapeutic work ; it answers all the tests which can be applied to it.

Sometimes a new tube is hopelessly reduced in its first few runs with the apparatus. Such a tube, if re-exhausted, frequently recovers and works well for long periods. The chief point to remember when using an X-ray tube is to work it carefully up to its highest degree of stability, this being its best possible condition for heavy and prolonged work.

The appearance presented by the tube in action has been described in the text and illustrated in the coloured frontispiece; the pictures shown were coloured from tubes made of glass prepared in Germany. Tubes made in England show a different picture, the colour being blue instead of apple-green. The difference in the fluorescence is due to the composition of the glass. It is therefore necessary, when using tubes, made of English glass, to remember the difference in the appearance of the active tube.

## THE TREATMENT OF DISEASES OF THE SKIN

No greater testimony to the value of X-rays in the treatment of diseases of the skin could be given than the fact that all skin hospitals have an X-ray department, and that nearly every specialist includes a more or less perfect installation in his armamentarium.

To get uniformly good results the technique must be thorough, and the operator able to reproduce at will definite conditions of the X-ray tube. Careful data must be kept in order to facilitate the reproduction of conditions known to have been useful in previous similar cases.

It may be laid down as an axiom that it is the chronic conditions of skin disease which receive most benefit from X-ray treatment, and that no case of acute disease should be treated by radiation before time has been allowed for the inflammatory processes to subside. An exception may be made if malignant disease is present, as there the inflammatory processes, if carefully helped by treatment, may lead to improvement.

Further, all previous treatment must be considered before X-ray treatment is commenced, and preliminary treatment by iodine, mercurials, and ointments containing metallic bases must be discontinued. The X-ray treatment should not be started at once in these cases; time must be allowed for these substances to be removed from the skin. Internal treatment by drugs need not necessarily be discontinued, though if it is desired to determine the value of X-rays unaided by these remedies they should also be discontinued. In some cases the iron and arsenic of tonics may, by circulating in the blood, aid in the curative effects by their secondary radiations. This point has been discussed elsewhere.

Subsequent to X-ray treatment, soothing lotions and ointments may be employed, but care must be exercised in their selection and use. In some cases the judicious use of a stimulating lotion or ointment may be necessary, but as a general rule all that is required is the dusting of the part with a powder containing starch and a little zinc oxide.

All crusts must, if possible, be gently removed from the surface to be treated; if a discharge is present the surface should be gently rubbed over with a pad of cotton wool. The exposures necessary are purely a question of experience, and the degree of filtration to be employed is determined in the same way.

The important point is to obtain the maximum of benefit with the minimum of harm, and it is well to bear in mind that serious harm may be done by the injudicious use of X-rays.

**Eczemata.**—Subacute and chronic eczema will often clear up under X-rays when all other methods fail. The first dose should be unfiltered with the tube fairly soft and a 3- to 4-inch spark-gap. A Sabouraud pastille should be coloured to the B tint, its distance from the skin being the half distance of the skin from the anti-cathode. It should be noted that dermatologists who use X-rays in treatment advise  $\frac{1}{2}$  PD or less in some cases. These minimum doses can be administered at frequent intervals. In this connection it may be observed that Hampson, Batten, and others employ the method by which the tube is brought nearer to the skin, and the pastille used on the skin instead of at the half distance; when using this method the dose should be estimated by Hampson's radiometer. But beginners are advised to adhere to the preceding method. Should the distance be greater than usual the dose requires to be longer. It is important that the pastille should always be at the half distance. Later doses should be given through an aluminium screen of  $\cdot 5$  mm. thickness.

This allows of more frequent exposures, and also of a harder ray being used when deeper than superficial effects are necessary. When the cure begins to progress the action may be continued by a dose once in three weeks. After the disease has disappeared it is well to give a few exposures at longer intervals to keep up the effect and prevent the recurrence.

**Psoriasis.**—This very persistent disease will frequently clear up under X-ray treatment. The technique is the same as that for eczema, except that in most cases  $\cdot 5$  mm. filter may be used from commencement of treatment. The effect of the filter appears to be that the superficial reaction is avoided, and the doses may be given more frequently. Large areas of psoriasis may be treated once a week for three or four weeks; later, once in three weeks is sufficient. A general effect as well as a local is often observed, patches at a distance from the area treated slowly clearing up. From his experience of X-ray treatment of psoriasis, the writer has arrived at the conclusion that cases thoroughly treated by X-rays clear up fairly rapidly, and do not show such a marked tendency to recur as they do when treated by other methods.

**Prurigo.**—Some forms of prurigo benefit by X-ray treatment. The technique employed should be similar to that for eczema.

**Lichen.**—Chronic forms are likely to improve under similar treatment.

**Leucoplakia.**—Many cases of this disease have been treated by X-rays. The writer is inclined to favour radium in these conditions, but good results may be obtained by X-ray treatment. A filter should be employed. It is well to remember that in many of these cases there is a syphilitic taint, and that in others the condition is complicated by a cancerous tendency. When the latter is present the case is likely to be very obstinate in its resistance to treatment. Cases which show no evidence of improvement are probably cancerous. The employment of hard tubes and adequate filtration, combined with frequent dosage, may lead to a rapid improvement in cases where no improvement had taken place under the lighter doses.

**Trichophytia or Ringworm.**—A number of diseases are due to the

presence in the horny structure of the skin of hypomycetes. The treatment, where the scalp is involved, is specially dealt with. When situated in other parts of the body characteristic chronic lesions are found. When situated in hairy parts of the body X-rays are useful. The action of the rays consists in epilation, and the removal of the parasite along with the hair. When the condition involves the nails and other parts, a few X-ray exposures should be tried, filtration and a hard tube being likely to prove useful.

The X-ray treatment of ringworm has been in general use since 1904. A very large number of cases have been treated since that time, and it is now generally recognised to be the most satisfactory treatment yet used for this very intractable disease.

The technique employed has been carefully elaborated by Kienböck. Dr. Adamson, who drew attention to this method in an article published in the *Lancet* in 1909, has simplified the technique, and in this country his is the one generally employed. It aims at the complete epilation of the scalp in all cases treated. There are exceptions to this, however. When the area of disease is localised to a small patch, it is well in some cases to treat the patch, and trust to preventive measures so far as the rest of the scalp is concerned. If the whole scalp is shaved at regular and short intervals until all the affected hairs have fallen out, the disease may be effectually checked. This is a good method to employ in young and delicate children, or in subjects who are suspected of being very susceptible to the action of X-rays. That such a susceptibility does exist in a very small percentage of individuals the writer is absolutely convinced. Every now and then, in spite of the most careful technique, a case is noticed which gives a violent reaction to minimum doses. Permanent alopecia may result in these cases. This exceptional sensibility to rays has been met with in adults, where there could have been no question of an overdose of X-rays, yet where a most violent dermatitis was set up by a single dose, which was much less than usual, the pastille being barely turned to the half tint, and the other factors, *i.e.* spark-gap constant and the time well under what was known to turn a pastille with the particular tube. Attention has been called lately to a variation in the X-ray tube, which could not be recognised by the ordinary methods, where the pastille was changed in normal time to the B tint, but where, nevertheless, the reaction which followed was very great. In spite of such evidence the writer has not the slightest doubt that very rarely will a case of extreme susceptibility be met with, and, so far as we know, there is no method by which we can determine beforehand the existence of such a susceptibility. Such individuals may be known to respond to other forms of skin stimulation. Thus there may be a history of reaction to sunlight or to counter-irritants or to antiseptic lotions, etc. Cases which show these characteristics should either be treated with extreme care or left alone.

Recognising that such cases must be met with in the practice of all operators, and taking all possible care to exclude them from active treatment, it must be admitted that X-rays are the best method we have for dealing with ringworm.

There are other points which must be taken note of before we treat a case with X-rays.

A careful enquiry must be made as to all previous treatment particularly in cases of long standing. Such cases have been frequently treated with counter irritants, as mentioned on page 298. No patient should be treated until all reaction from such treatment has subsided.

The existence of a septic condition of the scalp must be treated with caution, otherwise violent dermatitis may result.

It must be borne in mind that the tendency of the disease, if of long standing, is to produce a degree of alopecia which may be more or less permanent. Such cases will often give rise to trouble and anxiety in the after treatment.

Children who possess fair hair respond more readily to X-ray treatment than those with dark hair, consequently the dosage must in the former case be rather less than in the latter. Tuberculous conditions of the scalp are met with in children suffering from ringworm. These local patches may be stimulated and a degree of dermatitis set up quite independently of the X-ray treatment. Such conditions, however, generally subside and heal naturally.

The technique modified by Dr. H. G. Adamson is so complete and practical that we quote it as a guide for the treatment of all cases, with the exceptions mentioned above :

Epilation by means of the X-rays is now fully established as the most satisfactory method of treatment for ringworm of the scalp. By the introduction of Sabouraud's pastilles as a means of measurement of dosage, in trained hands the dangers of the treatment have disappeared. By Sabouraud and Noiré's method, with circular localisers, ten to twelve exposures are necessary in order to X-ray the whole scalp, and reckoning fifteen minutes for each exposure, the time occupied in X-raying the whole scalp is from 3½ to 4 hours. By the method to be described the number of exposures necessary to epilate the whole scalp is reduced to five, so that it is possible to irradiate the whole scalp in 1½ hours.

The essential features are that no cylindrical nor lead foil localisers are used, but that adjacent X-ray applications are made in such a manner that at those parts where overlapping does occur, the incidence of the rays is so oblique, and so much further from the source, that no excessive dose is given.

I have used this 5-exposure method with perfect results, every part of the scalp has received an even radiation, and the hair has fallen out completely, without any sign of overlapping margins or areas with non-fallen hairs as evidence of insufficient exposure. There is no sign of erythema : the regrowth of the hair has been normal over the whole scalp.

The details of the method, as Dr. Adamson employed it, are as follows :

1. The hair is clipped short over the whole head to facilitate operations.
2. Five points are marked out on the scalp with a blue skin pencil, as follows (see Figs. 217, 218) :

In the middle line.  $\left\{ \begin{array}{l} \text{Point A, } 1\frac{1}{2} \text{ to } 2 \text{ inches behind the frontal margin of the hairy} \\ \text{scalp.} \\ \text{Point B, } 1 \text{ to } 1\frac{1}{2} \text{ inches above the centre of the flat area which} \\ \text{forms the upper part of the occiput.} \\ \text{Point C, just above the lower border of the scalp at the lower} \\ \text{part of the occiput.} \end{array} \right.$

At the sides, Point D, on the left side, just above and in front of the ear.  
Point E, on the right side, just above and in front of the ear.

Measured with a tape measure, the distance between any two of the five points should be exactly 5 inches.

3. The five points are joined up by lines made with a skin pencil. These lines should meet one another at right angles. The mapping out of these points and lines need not occupy more than one or two minutes.



FIG. 217.—Diagram illustrating Dr. Adamson's method. (Schall.)

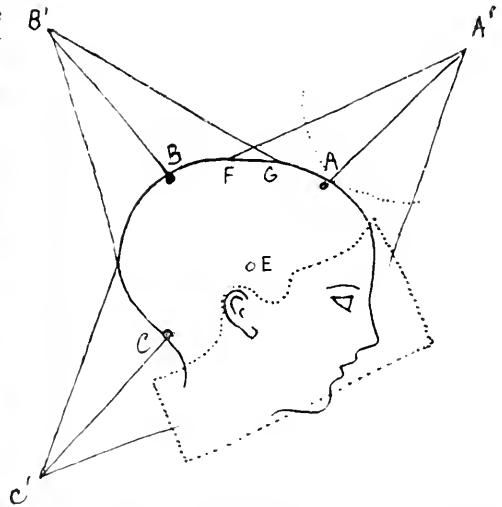

FIG. 218.—Diagram showing centres of areas to be rayed. (Schall.)

4. A Sabouraud pastille dose, with the anticathode at  $6\frac{1}{2}$  inches from the nearest point of the scalp, is given to the vertex, occiput, lower occiput, right side, and left side in succession, taking the points A, B, C, D, and E as the centre of each area to be rayed, and placing the tube so that the line joining the anticathode and the nearest part on the scalp is at right angles to a similar line joining the anticathode with each of the central points of the adjacent areas. The lines which have been drawn on the scalp connecting the five points give an indication of the direction in which the dose is to be aimed, *i.e.* of the position of the tube in relation to the head. The applications to the vertex, upper occiput, and the two sides are best made with the patient lying on a couch. The forehead and eyes must be shielded by a piece of lead or protective rubber during the exposure to the front of the vertex, and the ears and sides of the face when the sides of the head are exposed. The fifth application, that to the lower occiput, is best given with the patient sitting down and resting the forehead on a low table. A shield must be used to protect the neck.

In order to ensure fixing the anticathode at the correct distance from the scalp during the exposure, three slender wooden pegs are fitted to the box which encloses the tube. The pegs converge at their extremities to within  $\frac{1}{4}$  inch of each other, and are of such a length that the part of the scalp which rests against them is just  $6\frac{1}{2}$  inches from the anticathode of the tube. The pegs



are made of soft wood, so as not to obstruct the passage of the rays through them. The pegs rest against the scalp just over the blue marks A, B, C, D, and E, according to the area to be rayed. The aperture in the box through which the rays pass is 3 inches in diameter and  $3\frac{1}{4}$  inches from the anticathode, so that at the level of the points of the pegs the rays diverge to a circle of 6 inches diameter, and in this way one avoids the escape of rays into the room or towards the operator or on to the patient's shoulders, for a circle of this diameter is blocked by the patient's head. At the same time this circle of irradiation allows a sufficient margin for the necessary overlapping of the doses.

The essential points in this method are to direct each irradiation *at right angles* to the direction of the irradiation of adjacent areas, and to aim, not at a point in the centre of the vertex, of the lower occiput, or of the sides of the scalp, but towards the outer margin of these areas, so that half the dose goes on to the scalp and half on to the shield protecting the face and neck. If these precautions be taken there is no risk of over-exposure at the overlapping margins of the rayed areas. In practice the dosage works out so nicely that every part receives an equal amount, and epilation is total and complete, without anywhere a sign of over- or under-exposure. In theory, according to the well-known laws that the quantity of rays received at any point exposed varies (1) inversely with the square of the distance from the source; and (2) directly with the size of the angle of incidence, the dose received by any part of the scalp is found to be, with mathematical accuracy, one pastille dose.

In a case which has received a sufficient irradiation the hair begins to fall out about the fourteenth day, and epilation should be complete in from three to four weeks, a slight general erythema of the scalp, which soon subsides, being frequently noticed.

The regrowth of the hair is a matter of time, and varies in different subjects. It commences soon after the hair has fallen, and may be seen in the form of a fine down all over the scalp, the complete regrowth being generally well under way in three months from the time of treatment.

The variations may, however, be very great, *e.g.* the growth may be unequal, this depending upon the vitality of the hair follicles. The previous treatment may have devitalised the follicles to a more or less marked degree.

Careful attention must be paid to the following points in all cases:

(1) The scalp must be shaved before the treatment is undertaken. This enables the extent of the mischief to be determined, and facilitates the marking of the scalp. It also allows the rays to penetrate freely, thick hair acting as a filter, and preventing the thorough treatment.

(2) The scalp must be kept clean after the exposures; the head should be washed with soap and warm water two or three times a week. Until all the hair has fallen out the case is still infectious; it is, therefore, well to use a simple ointment, such as boracic acid (weak), or even vaseline, to prevent the spores from spreading, and possibly infecting other children. A skull cap of linen is useful for this purpose and also serves to keep the head warm. In some cases stronger antiseptic ointments may be used.

**Folliculitis Barbae.**—Satisfactory results may be expected if the proper technique is carried out. Care must be taken to regulate the dose, so that no permanent damage to the hair follicles results. It must be insisted upon

that no active local treatment be carried on simultaneously with the X-ray treatment. A full erythema dose should be given unfiltered, and three weeks allowed to elapse before a repetition is given. The affected hairs fall out, and the condition rapidly improves. Subsequent treatments should be given at three or four weeks' intervals. Generally one thorough dose is sufficient to cure the condition.

**Lupus Vulgaris.**—This condition readily responds to X-ray treatment. Sometimes in remote situations of the body it will be necessary to resort to radium because of the greater facility this remedy offers in application. When the disease is situated on an accessible part of the body, X-rays should be the remedy employed.

Finsen light has been extensively used for the treatment of lupus, but X-rays will do all that the light can do, and they are more easily employed. The treatment is much shorter, and not nearly so tedious, and the results are obtained in shorter time and are quite as good and lasting. Several cases which did not respond to Finsen light treatment have cleared up after a short course of X-rays. To select the proper degree of hardness of the ray is the essential point, and filters should be used. After the lesion has healed, several thorough doses should be given at intervals of several weeks, and the patient should be kept under observation for a considerable length of time in order that any recurrence may be detected at the earliest possible date, and promptly treated. The results obtained by X-ray treatment are excellent, and the degree of reparative change which the tissues show is often remarkable.

**Lupus Erythematosus** is another condition which responds to ray treatment. It is, however, a very chronic condition, and tends to spread after treatment has ceased. The occurrence of telangiectasis is not uncommon after prolonged X-ray treatment in a percentage of cases treated.

**Acne Vulgaris.**—When widely spread this condition is difficult to treat, but several exposures given at intervals, covering the whole of the affected area, will tend to a considerable improvement in the condition. The technique is similar to that for eczema.

**Verrucae Vulgari or Warts.**—This condition is particularly amenable to X-rays, but there are other remedies which are quite as efficacious. Carbonic acid snow and radium act well. Two or three exposures to X-rays lead to a rapid disappearance of the warts.

**Cheloid.**—This condition is rapidly and permanently influenced by X-ray treatment. As it occurs so frequently after operations for cancer and other conditions, the radiotherapist has many opportunities of observing its progress after treatment. The transformation of a thick fleshy cheloid condition into a soft flexible scar is one of the most remarkable instances of the reparative change which can be induced by ray therapeutics. The relief obtained is also great, the scar becoming flexible, and the movements of the limb rapidly improving. The treatment requires to be thorough, and the whole of the cheloid must be treated equally and regularly. A full pastille dose may be given without a filter, and at the end of fourteen days a

second dose, with .5 mm. of aluminium as a filter, will induce the necessary degree of reaction. This must be kept up by subsequent doses at regular intervals, until the whole scar approximates to the normal. The results obtained in extensive cheloid after burns are highly satisfactory, the irritation which is so common a symptom in these cases being quickly relieved, often permanently. A soft pliable scar takes the place of the thickened and unsightly one found before treatment.

**Chronic Syphilitic Lesions of the Skin** are often sent for X-ray treatment, either with or without an established diagnosis. When very obstinate, a few X-ray exposures will serve to stimulate the tissue changes and tend to improvement, especially if antisyphilitic remedies are employed at the same time. It should be noted that these cases frequently respond actively to minimum doses, so care must be taken not to push the treatment too far or too rapidly. Time must be allowed to observe how the condition is likely to react before further doses are administered.

**Simple Ulcers.**—These readily respond to X-ray treatment. Unhealthy sores will assume under treatment a healthy granulating appearance, and in time will heal completely. The resulting cicatrix is generally a good one, and will in all probability give no further trouble.

**Fissures** in the skin and mucous membrane and fissured ulcers of the tongue are frequently greatly improved by adequate treatment.

**Chronic Ulcers** which fail to improve under other remedies will show a marked improvement when treated by a few pastille doses; where granulations are present, but flabby, the stimulating effect of the rays greatly helps to an improvement in the general condition of the ulcer. Many cases heal slowly with prolonged treatment.

**Malignant Invasions of the Skin** will be dealt with in the section on the Treatment of Malignant Diseases.

**Hyperidrosis.**—Excessive sweating in various situations of the body is a condition which up to the time of treatment by X-rays was the despair of the skin specialist. Whatever its situation, it is a most unpleasant condition to deal with, and a source of great annoyance to the patient. The common situations are the axillæ, the hands, the feet, and the head. Wherever it occurs, it may be readily and permanently cured by X-ray treatment. Howard Pirie drew attention to this method of treatment, and published a number of cases which demonstrated the great value of X-rays in this disease. No more striking testimony to the efficacy of X-rays in therapeutics could be obtained than the results of treatment of this condition.

The writer has treated a number of cases with invariably excellent results. The marked improvement in the condition after a few exposures is very gratifying.

*Technique in the Axilla.*—The arm is extended and placed over the head, the axilla being fully exposed. A circular aperture is made in a piece of lead rubber protective, and then a piece of lint is laid over the axilla, exposing the whole of the apex and the axillary hair. The tube-box with the tripod already described is brought close down to the skin, the apex of the tripod

being on a level with the apex of the axilla. A full pastille dose is given, and at the end of fourteen days another exposure is given, a .5 mm. filter being employed for this and subsequent exposures. No improvement is noticed until after the second or third administration, when a slight reddening of the



FIG. 219.—Chronic ulcer of hand of several years' duration, showing improvement under X-ray treatment.

skin results, there being also slight irritation at this stage. The sweating slowly diminishes from this stage until a complete cure is obtained, four applications being usually sufficient to cure the condition. It is better to obtain the result gradually by the above method, though occasionally, when the dose has been heavier, a marked improvement may follow the first exposure. It is also well to aim at a partial effect only; a slight degree of sweating is practically a normal condition, and is what should be attained. If the sweating is completely stopped, a dry condition of the skin may follow,

which may be troublesome. It is frequently noticed that the axillary hair is not completely epilated, which rather suggests that less than a full erythema dose is sufficient to destroy a large percentage of the sweat glands. The hands and feet may be treated in exactly the same way. The head requires to be dealt with carefully, otherwise a troublesome alopecia may result.

## THE TREATMENT OF ENLARGED LYMPHATIC GLANDS

**Enlarged Glands** may be described as (*a*) simple inflammatory; (*b*) tuberculous; (*c*) lymphadenomatous; (*d*) lympho-sarcomatous; (*e*) carcinomatous; the two latter being generally secondary to a lesion elsewhere.

**Inflammatory Glands** which come for treatment are generally chronic; they readily respond to the X-ray, and diminish rapidly in size.

As these glands are frequently secondary to septic conditions elsewhere, a search should be made for the primary lesion, and this should be treated as well as the glands. If treated early, before suppuration has occurred, these glands will sometimes subside. If suppuration is present, the abscess should be opened, and afterwards a number of X-ray exposures will greatly facilitate the repair of the parts. This is particularly appreciable where an intractable sinus exists. It may be injected with bismuth emulsion, and a thorough irradiation given.

The treatment of **Tuberculous Glands** by X-rays offers a good alternative to that of removal by operation, and when operation is recommended a few preliminary exposures should be given in order to induce inflammatory changes around the glands.

Glands, which on account of the extensive nature of the condition renders operation a serious matter, either because of the wide distribution of the swelling, or on account of suppuration already well advanced, may be treated vigorously by weekly doses. In the absence of more operative treatment suppuration should not be a contra-indication to X-ray treatment; such treatment should rather be pushed vigorously. When pus has formed it should be evacuated and the treatment continued. It is remarkable how some of the cases improve from the commencement of X-ray treatment. The action is undoubtedly a general and local one, the former appearing to exert a tonic effect upon the tissue metabolism.

**Lymphadenomatous Glands** are frequently treated by X-rays, and behave in much the same manner as tuberculous glands, sometimes disappearing rapidly or diminishing to a very small size. Their peculiar characteristic is that they tend to reappear, or rather, a group of glands will diminish in size, and after treatment is discontinued for a time the lumps become evident again, but whether they are the same glands or others which have become involved is a matter of conjecture. The practical point is that this

type of gland is particularly amenable to X-ray treatment, but the treatment cannot be definitely described as a curative one until months or years have elapsed without recurrence. The experience of most workers is that ultimately recurrence takes place, and the patient dies from the disease. The probability is that a percentage of the cases which are cured may have been of the simple inflammatory type.

The treatment must be thorough; areas in which glands are evident should be treated. It is a good plan to treat all the areas involved in rotation, taking care to cover as wide an area as possible at each treatment. In this way it is possible to secure a rapid response to treatment. The irradiation should be continued long after the patient appears to have recovered. It is possible that in a number of the cases where there has been recurrence, efficient after-treatment has not been carried out. A dose once a month for many months will not harm the patient, and it may possibly keep up the beneficial action of radiations.

Recently, by using hard rays and aluminium filters, 1 mm. to 2 mm. thick, it has been possible to give more frequent doses, and a marked improvement in results has been obtained.

**Enlarged Sarcomatous Glands** may be a manifestation of lymphosarcoma or secondary to a primary sarcoma in an adjacent part of the body. In the former, the treatment of the local condition must be pursued as well as of the deposits in the mediastinum. Frequent dosage with hard rays is indicated. The glands slowly diminish in size, but never quite return to the normal condition; sooner or later the glandular enlargement increases, and in spite of treatment the patient succumbs to the disease.

Secondary deposits of sarcoma in the glands yield to treatment for a time. Several cases which have been treated by X-rays and radium have remained well for several years. The latter agent appears to have a decidedly beneficial action upon sarcoma.

**Enlarged Carcinomatous Glands** are generally secondary to a primary lesion in another part of the body, and may occur in any part of the lymphatic system. The primary lesion will be found in some adjacent part or organ. They differ from the preceding types of gland by slow growth, are generally not numerous, and may be confined to one particular chain of lymphatic distribution, corresponding to the site of the primary lesion. They do not tend to suppurate. The skin may at a later stage become involved, and ulceration follow. The response to treatment is slow, marked inflammatory surface reaction being often necessary before an appreciable effect is noticed upon the size of the glands. In these cases it must be recognised that if benefit is to be received the possibility of damage to the skin must be partially disregarded, though all precautions must be taken to avoid it or reduce it to a minimum.

But several cases have remained stationary until a degree of ulceration of the skin surface has been brought about. This will gradually heal, and at the same time the glands slowly subside. They seldom disappear entirely, but appear to become quiescent. In several patients, where such a change



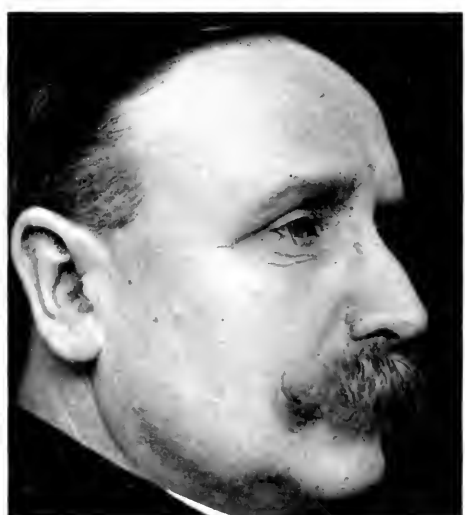

PLATE LIX. — RODENT ULCERS TREATED WITH RADIUM, X-RAYS, AND  $\text{CO}_2$ .

*a.* Rodent ulcers on left side of face; these rapidly healed after radium exposures and remained healed.

*b.* Small rodent ulcer of right side of nose, healed all but a small area at the lower edge of the ulcer; this has been most intractable to X-rays, radium, and  $\text{CO}_2$ .



has been induced, it has been possible to remove the glands surgically, and continue the X-ray treatment afterwards.

The condition of a patient so treated is infinitely better than when the glands are allowed to enlarge slowly, involve the skin, and ulcerate. Once a carcinomatous gland arrives at the stage where it breaks down all barriers and reaches the surface, no amount of X-ray or other treatment has any effect. The technique is somewhat similar to that for tuberculous glands. Weekly doses with filtered rays may be employed, taking care to cover a wide area, and changing the area as frequently as possible. In advanced cases, with groups of greatly enlarged glands, it will be necessary to administer heavy doses rapidly. This may be safely done when the rays are filtered through three or more millimetres of aluminium. Doses of 20 or 30 X Kienböck may be given to numerous small areas of skin covering the enlarged glands. In this way large aggregate doses of 200 to 400 X may be given to a group of glands at one sitting. After a suitable interval, depending upon the degree of reaction and the urgency of the symptoms, the dose may be repeated.

## THE TREATMENT OF RODENT ULCERS

The treatment of rodent ulcer by X-rays has yielded many good results. When the disease is superficial a marked improvement is quickly obtained. The tendency in all cases is for recurrence to show itself, and adequate steps must be taken to endeavour to prevent this recurrence. This can best be done by thorough prophylactic treatment after the ulcer has disappeared, though even then disappointment will occasionally be met with. In some cases, in spite of most thorough prophylactic treatment, the scar breaks down and the resulting ulcer spreads.

When bone or cartilage becomes involved the difficulty of healing the condition is great. Sometimes the ulcer heals and remains well for long periods. This indicates that in the particular case adequate treatment has been carried out. The exact rationale of the treatment is somewhat difficult to follow. Why some cases do well and others do not is not yet understood.

Two cases may be quoted to illustrate this point.

*Rodent Ulcer on Left Side of Face.*—Mrs. E., 57 years of age. From December 1908 to March 1910 she received about fifty radiations. The condition gradually improved, but as soon as treatment was stopped the growth resumed an active form. On March 11, 1910, she had a short exposure with radium. The part treated improved greatly for a time. The ulcer was ultimately excised. This is a type of slow-growing rodent ulcer which does not respond readily to any form of treatment.

*A Small Rodent Ulcer on the Right Side of the Face in line with the Orbit.*—R.M., 41 years of age. The growth had been noticed for twelve months prior to treatment. It had been cauterised on three occasions without any apparent benefit. From September to December, 1909, sixteen radiations. The surface

healed over and had a depressed appearance in the centre of the cicatrix. The edges remained smooth. It remained well until April 1910, when the anterior edge resumed activity, and slowly spread. Several radiations resulted in a cure for a time at least. The last treatment given resulted in a fairly active dermatitis, which seemed to have the effect of healing the active portion of the growth. This case responded remarkably well to X-rays, and affords a great contrast to the preceding one. It illustrates the point that the earlier these ulcers are subjected to X-ray treatment, the better is the prospect of a cure.

Very superficial ulcers heal readily and remain healed for long periods. The position of the ulcer appears to determine the result in some cases; when situated on the cheek, away from the orbit and clear of mucous membrane, the ulcer will readily yield to treatment; when situated near an angle at the junction of skin and mucous membrane, such as the angle of the mouth or orbit, the difficulty of equal and adequate treatment becomes greater. It is often impossible to get the rays equally spread over the whole of the ulcer, and if there is inequality of the surface the same appears to apply. It is also possible that many of the cases which do not heal under treatment have been treated with the wrong quality of ray. We must remember that the X-ray beam is heterogenous. Consisting as it does of a bundle of rays of unequal penetration, the beam from any given tube may contain rays in the discharge of from, say, 1 to 12 Bauer. The preponderance of value 4 may be sufficient for the stimulation of the tissues of a particular ulcer while it would have no effect upon another. It appears reasonable to assume that in some instances we accidentally use the ray of the greatest value for the case under treatment, while on another occasion, using the same tube in the same condition on another case, the result will be quite different. It would appear that up to the present the bulk of the therapeutic work done with X-rays has been more or less haphazard. This no doubt explains the varied results obtained. An effort must be constantly made by each operator to standardise his apparatus in such a way that he may be able to produce at a given time, approximately at least, a particular quality of ray for a special purpose.

The frequency of the applications must also have a direct influence on the result, some operators preferring to wait three or four weeks before repeating an exposure, while others do so at the end of a week. The obvious course to pursue is to observe carefully the condition requiring the treatment. If the ulcer is growing rapidly extreme measures must be adopted. The dose should be the maximum possible and should be repeated at the earliest convenient date. The edges of the ulcer may be given an excessive dose by protecting the less active part with lead rubber; the healthy skin, all but that close to the edge of the growth, must also be guarded. The degree of reaction induced will depend upon several factors, (*a*) the duration of the exposure, (*b*) the hardness of the X-ray bulb, (*c*) the filtration employed; each of these factors must receive special consideration.

In superficial conditions the first dose should be given unfiltered, and a full pastille dose given. If possible, it is well to wait for fourteen days



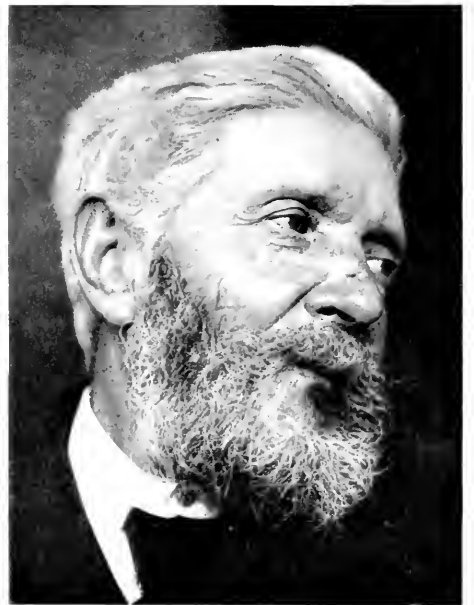

PLATE LX. CASES OF RODENT ULCERS TREATED WITH RADIUM.

*a, b.* Illustrates a case which has resisted all forms of treatment, including X rays, radium,  $\text{CO}_2$ , and mercury vapour lamp; several intensive doses of X-rays appeared to induce healing of the ulcer for a time. Recurrence took place at the lower edge, this rapidly extended until the lower half became ulcerated.

*c, d.* A case which yielded to treatment. *c.* Before treatment. *d.* Towards the end of treatment the ulcer completely healed; recurrence after many months quickly responded to further treatment. The patient has had several recurrences, each of which quickly heals after radium has been applied.

before repeating the exposure. This allows the operator to determine the degree of reaction the tissues possess. If, however, the growth threatens to spread more rapidly, a further exposure must be given at once, and this one should be filtered. It is well to bear in mind that it is possible to stimulate a growth by X-rays and to get a harmful rather than a beneficial influence exerted upon it.

If, in spite of ordinary full doses of X-rays, the ulcer goes on steadily increasing, what more can be done? The obvious course is to increase the dosage further. In special cases where time appears to be of value two or more pastille doses may be given at once, the healthy parts being well guarded. The case illustrated shows the value of this method (Plate LX., Fig. *a*). A rodent ulcer on the right side of the forehead resisted all forms of treatment by X-ray, radium, carbonic acid, and high frequency. It gradually extended, especially at its lower border. Two unfiltered doses were given, and at the end of a week two more were administered, treatment being then suspended for several weeks. The ulcer healed over the whole of its surface, a thick crust forming at the lower angle. The patient imagined he was cured and did not return for more than three months; at that time the crust formed at the lower edge of the ulcer had led to ulceration below its surface, which was slowly spreading. Further treatment led to a marked improvement in the condition, but completely failed to heal the ulcer.

After an ulcer has been healed it is necessary to continue treatment. Repeated doses may be administered at intervals of several weeks, filters being employed and a harder tube used. By these means it may be hoped to obtain an effect upon the deeper structures which may contain remnants of growth. The fibrosis induced by treatment should arrest the growth of these remnants.

In obstinate cases it is wise to vary the remedy employed. Thus radium may be used or carbon dioxide applied to parts of the ulcer. The high-frequency current will sometimes give the necessary stimulus to parts of the ulcer. A preliminary exposure to the mercury vapour light, followed by X-ray dosage, sometimes aids the process of healing. The light appears to increase the superficial circulation, by congesting the parts; the secondary radiations may be induced by the direct action of the X-rays on the fluids circulating in the vessels of the growth.

The distinction drawn between rodent ulcer and epithelioma is more or less an arbitrary one, many of the ulcers which we call rodents really being from the beginning epitheliomata, this difference, no doubt, in part accounting for the wide variations in the result of treatment, the epitheliomata being more resistant to treatment by radiations. The latter growths tend to spread to the deeper parts and involve the tissues below the skin. When cartilage and bone become affected the difficulty in inducing healing is greater. Much more penetrating rays should be employed, and longer and more frequent exposures given. In some cases it is well to combine surgical measures with the X-ray treatment. When possible, the more or less complete eradication of the ulcer, followed by thorough X-ray

treatment, appears to be the most rational method that can be employed.

### The Treatment of Epitheliomata

These tumours, when seen early, and more especially when they involve mucous membrane, should be promptly excised. After-treatment by X-rays should be employed, and should cover a wide area to include the lymphatic distribution of the affected part. Should the patient refuse operation, radium should be the next choice, and failing the possibility of treating by this remedy, X-rays should be used, or radium and X-rays together or alternately. It is important to keep the patient under observation for a lengthy period.

Epithelioma involving the skin only is more amenable to X-rays and radium. A few exposures should be given previous to operation, if this be decided upon, and continued after the removal of the active growth.

## THE TREATMENT OF SARCOMATA

Sarcomata, other than glandular, may require to be treated. Such, particularly the round-celled variety, when situated in the soft parts of a limb or in bone, respond readily to treatment, and diminish in size or may to all outward observation disappear. The tendency is for recurrence within a year or so, and often in the deeper structures, particularly in the mediastinum or lungs. The after-history of these cases is very little, if any, worse than in the operative cases, where recurrence is almost certain to take place within two years.

The advantage of the operative method over treatment by radiations is that the patient is saved from the local discomfort of a growth which in the end breaks down and forms a sloughing ulcerated sore. Two cases may be quoted to illustrate this point, one that of a girl who had a primary sarcoma of the humerus which practically cleared up under X-ray treatment. Recurrence took place in the left hip-joint, but before the patient died the primary tumour reasserted itself and formed a large sloughing sore.

In the second case a primary sarcoma of the right humerus was removed by operation, together with the shoulder girdle and upper limb. Recurrence took place after two years in the mediastinum and lungs.

## THE TREATMENT OF CARCINOMATA

The majority of the cases of malignant disease treated by X-rays belong to this group. Marked improvements have taken place in results in recent years. This has been largely due to two factors: (*a*) a better technique, and (*b*) the earlier treatment of many of the patients.

The improvement in X-ray technique has been very great of late years, the use of larger tubes of great penetrative power, together with an improve-

ment in the construction of coils, transformers, and accessory apparatus, having made it possible to greatly increase the dose given. The use of filters of a thickness of  $\frac{1}{2}$  to 3 mm. of aluminium, or its equivalent in other materials, led to the use of a penetrating ray which could be used to give large doses with practically no effect upon the skin surface. These large doses have been extensively used in the treatment of carcinoma, with very marked improvement in the results obtained. The beneficial effects of X-rays upon uterine myomata encouraged workers to try similar methods in the treatment of all kinds of carcinoma, both superficial and deep. If the skin surface is divided up into small areas, the dosage in a particular case may be increased to a marked extent; 1000 X Kienböck may be administered in a short time to a tumour. In deep-seated carcinoma of the uterus the treatment employed should be administered by two routes—the perineal and the abdominal.

The methods of treatment may be divided for practical purposes into four main groups:

- (a) Prophylactic, before and after operation;
- (b) Curative efforts in primary growths, which should consist of thorough irradiation of the growth, enlarged glands and the adjacent lymphatic area;
- (c) Treatment of recurrences of all degree;
- (d) Palliative treatment of cases where all hope of cure has gone.

These groups require lengthy discussion.

**Before Operation.**—In all cases where time permits a number of X-ray exposures should be given. The first exposure may be given unfiltered and later ones should be passed through .5 mm. of aluminium.

There should be no delay in performing the operation, but, usually, a few days elapse between diagnosis and operation, and during these one dose at least may be administered. The whole area of the growth should be well irradiated and then the area of lymphatic distribution spreading from the growth should be fully exposed. Thus in carcinoma of the breast the whole breast may be treated with one dose, or, if the tumour is large, the breast may be divided into four areas and four exposures given. This method will be described later. The axilla should get a full dose. This exposure will have the effect of epilating the axillary hair and will exert an action upon the sweat glands, causing a diminution of the secretion of sweat, an effect advantageous in keeping the axilla clean after the operation. When time permits a second filtered dose may be given over the whole of the areas previously treated.

**Post-Operative Treatment.**—In cases which have had the preliminary exposures this should be continued as soon after operation as possible. In cases which have not had the preliminary treatment, the same routine should be employed. The following description therefore applies to both cases.

As soon as possible after the operation the patient should be irradiated over the whole of the areas already described. It is of extreme importance that a thorough routine method should be employed. The difficulty lies in the fact that unless great care is exercised to irradiate the whole area

equally, portions of the surface may not get a full dose. In the experience of the writer recurrence has taken place in areas which have escaped treatment. An attempt must be made to elaborate a technique which will give an equally distributed dose all over the breast area, axilla, supra-clavicular region, and well down below the costal margin. A method similar to that used in the treatment of the scalp for ringworm might be employed. The whole of the area to be treated should be mapped out and central points selected which will get the maximum dose. Spreading from these points to the periphery of the area the rays diminish in a definite proportion. The peripheral areas of each exposure should overlap so that that part of the skin receives a half dose from each adjoining exposure.

Points should be selected at equal distances in the mid-mammary line, extending from the costal margin to the clavicle and upwards, to take in the supra-clavicular region. A number of corresponding points should be marked out in the mid-axillary line, and, each point being taken as the centre of the exposure, it is possible to give an equally distributed dose over the whole area. The axilla should in addition have a dose from its posterior aspect.

The first series of doses may be given unfiltered. At the end of a week a second dose is given, using a  $\cdot 5$  mm. aluminium filter. Later doses should be administered according to the degree of reaction which results. In all, twelve exposures to the whole area should be given, the later irradiations being given at longer intervals. Towards the end of the series the interval should be about three weeks, and for the later doses thicker filters and hard tubes should be employed.

At the end of the dozen exposures the patient should be allowed to cease coming for treatment, but should be kept under observation for several months in order that the earliest appearance of recurrence may be promptly dealt with.

A useful routine for the use of filters is to give the first dose unfiltered, the second, third, and fourth with  $\cdot 5$  mm. filter, and then to proceed to 1 mm. for three or four doses, and 2 mm. for the later exposures, the object of the filter being to protect the skin as much as possible, and to exercise an action on the deeper structures by penetrating to the deeper layers of the skin and the deep tissues.

The results of prophylactic treatment by X-rays are encouraging. The effect is marked from the first. The patient has less pain, the movements of the parts are facilitated, and the scars are more pliable at an earlier date than when no treatment is carried out. The general tonic action of X-rays upon the metabolic processes is noticed, patients feel well and the general health is improved by the treatment. That recurrence may be prevented is fairly well established, especially in view of what we know to occur when early recurrences are treated. These undoubtedly disappear after treatment, and it is logical to assume that remnants of cancer left in the wound may disappear in the reparative changes set up in the surrounding tissues by X-ray treatment when the treatment has been efficiently carried out.





PLATE LXL.—CARCINOMATA TREATED BY X-RAYS.

*a.* Primary growth, a large ulcerated carcinoma of right breast which improved after being treated by a prolonged series of X-ray exposures.

*b.* Recurrent growth in scar after operation for removal of carcinoma of right breast. Successful treatment by X-rays.

This is one of the very early cases treated at the Cancer Hospital, when small unmeasured doses were given at frequent intervals over a long period of time.



**Treatment of Inoperable Carcinoma.**—The technique in the treatment of primary growths, unsuitable for operation, being similar, the description under (a) applies to both groups. A classification is necessary in order to describe fully the methods employed.

(a) *Large inoperable cancer* of the breast without ulceration is fairly common. An attempt should be made to reduce the tumour by treatment to an operable condition. When the breast is very large a system of treatment may be used which will give the dosage on a limited area. The breast is divided into four or more areas by means of a lead-rubber screen marked out as follows: A square of thin material is cut to cover the whole breast and a margin of tissue beyond; this is divided into four equal parts, and one segment is cut out. Two points are marked on the skin at the upper aspect, and the upper limits of the screen are placed on these points. An exposure is given through the segment which has been removed. The screen is then moved round one segment and the exposure repeated. This is done until the four areas have been treated, the tube in each instance being directed towards the centre of the breast. This method has been successful in several cases, the tumour rapidly diminishing in size.

The gratifying results obtained in the treatment of uterine fibromyomata by the intensive method of dosage have led to marked improvements in the technique of the treatment of carcinomata. A filter of 3 mm. is used, a secondary filter consisting of two or more layers of loofah sponge enclosed in several layers of lint being used to protect the skin. The area to be treated is marked out into a number of small squares. Lead is used to protect the adjacent areas during the exposure. As many as twenty areas may be mapped out to cover the region requiring treatment, each area receiving from 10 to 20 X on the Kienböck scale. In this way a relatively large dose is administered to the affected area. The tube used is of the hardest possible penetration, 10-12 Wehnelt. The patient should be kept at rest for a day or two after the administration of the rays. The dosage may be repeated in from two to three weeks, or at shorter intervals if there are no untoward symptoms shown. These large doses of X-rays appear to exercise a marked influence over the diseased tissues. Continental workers claim marked improvement in cases treated by the intensive method. It is possible that with further improvement in X-ray tubes, the results produced may be still greater.

Exposures through thick filters may be given twice a week in serious cases. Several layers of chamois leather should be laid upon the skin in order to prevent secondary radiations damaging the skin.

(b) *Ulcerated growths* should be treated by a modified method. An ulcerated surface will stand more treatment than the unbroken skin, and there is no need to attempt to protect it. The healthy skin around the ulcerated surfaces, all but a narrow margin surrounding the ulcer, should be protected.

Frequent irradiations are given to this area until it shows signs of breaking down. In the end the cancer mass sloughs and leaves healthy tissue behind, this closing up and occasionally healing.

The illustrations shown are from two cases treated in this manner. Figs. *a*, *b*, *c*, and *d* in Plate LXII. are from a case treated on the lines indicated above. They show the progressive changes induced, viz. sloughing and gradual repair of the resulting ulcer. At one stage this tumour received radium treatment.

Fig. *a* in Plate LXI. is from another case which is showing marked improvement under X-ray treatment of the intensive type.

The treatment of recurrent cancer when the growth has reached a large size may be carried out on precisely the same lines as that for primary cancer. Many cases could be quoted where undoubted benefit has resulted from thorough X-ray treatment.

(*c*) *Recurrent Cancer*.—These cases form a large percentage of the patients one is called upon to treat. The condition varies from the melon-seed variety to large nodules of cancer. All cases do not respond equally to treatment, a number going steadily from bad to worse. As a general rule, the instances which occur in young women under 35 years of age do not respond well to treatment; after that age, if treated early, the chance of a good result is much greater.

In this class of case the treatment should be pushed vigorously until a marked reaction is obtained all over the affected surface and well beyond it. When the reaction shows itself the seed-like bodies slowly subside. Repeated crops may require to be treated in the same patient. Several cases of this type have been undergoing X-ray treatment for two or three years at regular intervals.

## THE TREATMENT OF ENLARGEMENT OF THE PROSTATE GLAND

Of late years this condition has been treated by X-rays and radium. The enlargement, if simple, is an hyperplasia of the glandular elements, a condition which should be amenable to therapeutics. It must not be overlooked, however, that in some of these cases there is a large fibrous element in the growth, and this may be fairly dense in structure. Further, these conditions may be complicated by the presence of stones or calcified matter in the substance of the gland. The presence of a commencing new growth has also been shown in what was otherwise to all appearances a simple enlargement of the gland. Cases for X-ray treatment must therefore be carefully selected in order to avoid bringing discredit upon the method of treatment. No doubt can exist as to the brilliant results obtained in this condition by operative measures, and the writer is convinced that X-ray or any other palliative form of treatment will never take the place of early operation.

With the reservation indicated, good results have been obtained by both X-rays and radium. It is a matter of general observation that when so treated the condition of patients is ameliorated, the control of micturition is re-established in some cases, and prolonged treatment results



PLATE LXII.—STAGES IN THE TREATMENT OF AN ATROPHIC SCIRRHOUS CANCER OF THE BREAST.

*a*, Before treatment. *b*, Growth commencing to ulcerate. *c*, Growth nearly all gone. *d*, Healed. Recurrence took place at the lower end of the scar, and the patient is still under treatment.



in a marked diminution in the size of the gland. Large prostates may by this line of treatment be reduced to an operable size. Even in the cases which are operable, circumstances may exist which indicate a palliative line of treatment rather than the radical one of removal. The patient may refuse to take the risk of an operation, or his condition may be such that an operation would be extremely hazardous.

The technique is similar to that for other deeply-seated structures; two routes are available, both of which may be employed in the one case. The perineal route is preferable. Hard tubes should be employed and filters used from the commencement of treatment. It is important to prevent dermatitis as long as possible in order to get a sufficient dosage into the deep structures.

Commencing with a 2 mm. filter, a pastille dose at the half distance may be given weekly. The pastille is used on the distal side of the filter, and the patient, therefore, receives a full dose at each sitting. After three or four doses with this thickness of filter it will be found necessary to increase the thickness to 3 mm. and later to 4 or more.

The skin must be carefully watched for reaction. Should this be excessive the treatment must be suspended for a time by that route, and the suprapubic route may then be utilised. A compressor should be employed and the tube brought well down towards the pubis, a cylinder compressor being a good one to use. The gland can thus be irradiated from above for several doses, and then the perineal route can be tried again. In this way it is possible to keep on with treatment for a considerable length of time. Improvements generally begin to show after three or four doses, and as a result of the increase of comfort the general health of the patient improves greatly.

An alternative method of treatment, and one likely to take its place, is the following: a large amount of current, 4 to 5 milliamperes, is passed through a hard tube, 10 Bauer, a 3 mm. aluminium filter being employed, and the dose measured by Kienböck paper. At least 10 X on the skin surface is given, the perineal and suprapubic routes being employed with as many ports of entry as possible, so as to get in the maximum dose to the gland.

## THE TREATMENT OF EXOPHTHALMIC GOITRE

The routine medical treatment by drugs has proved to be merely palliative, and operative treatment has not been marked by any striking successes. X-rays appear to offer a chance of better results than either of the two older methods. The rationale of the treatment by X-rays is difficult to understand. A purely local effect can easily be produced, but there must be a deeper and further-reaching influence induced by the ray to explain the undoubted improvement which takes place in these cases. In a disease which, grave in itself, is frequently accompanied by other conditions, such as rheumatoid changes in the joints and conditions associated with rheumatism, it is unwise to claim too much for X-ray treatment, yet in

suitably selected cases good results may be confidently expected. The technique employed must be thorough. The gland when greatly enlarged offers a good field for the preliminary exposures, which should be given once a week and continued steadily until marked improvement results. Should reaction lead to a suspension of the local treatment, the radiations may be continued on the surrounding areas, particularly on the region of the cervical sympathetic. The action is apparently a general one rather than a local, and therefore the area of exposure need not be limited. An occasional dose may be applied to each axilla alternately.

Does treatment by radiations lead to changes in the gland secretion or in the blood serum, thus producing an amelioration of the distressing symptoms, or does the treatment restore the function of the gland to a normal condition? Whatever happens there is no doubt that many of the cases treated by X-rays are restored to a normal state of health.

The aim of treatment should be to slowly induce a return to the normal, consequently it will be found advantageous to proceed slowly with the treatment; in cases which are not very acute a dose once a week to one side of the neck will suffice. Alternate doses should be given to either side of the neck. It will be an advantage to employ filters, commencing at 1 mm. thick and increasing as the occasion indicates. Should the symptoms be very acute the dosage may be increased both in frequency and strength. A hard ray is employed, and this should be filtered through 3 mm. of aluminium. Three areas may be marked out over the enlarged gland, and each is given 10 X Kienböck. This may be followed in a week or ten days by another application. In more severe cases, which are confined to bed, it is a good plan to use radium rather than X-rays.

From experience of X-ray treatment in other diseases it would appear that, in order to maintain the improvement, it will be necessary to give regular doses of X-rays at intervals for a long period of time. Dr. Florence Stoney in an interesting paper quotes results which are encouraging. She advocates X-ray treatment in preference to operation. In 47 cases, 7 gave up treatment too soon, 14 were completely cured, and 22 derived great benefit. Under treatment which is pushed to the point of dermatitis, the pulse comes down to normal, the goitre in many cases, and the exophthalmos nearly always, disappearing. Tremor and perspiration are slow to yield but do so eventually.

The writer is strongly of opinion that this form of treatment should have a trial in all cases, even when operation is contemplated.

## THE TREATMENT OF UTERINE FIBROMATA

The value of radio-therapeutic measures in diseased conditions is clearly demonstrated by the success which has been achieved in the treatment of uterine fibroids. These conditions would appear to offer an ideal field for the action of radiations, as from our knowledge of their action on superficial structures we find that hæmorrhage may be checked and fibrous and cellular



structures readily reduced in size. The difficulty up to recent times has been to act on deep-seated structures in such a way that reduction in size of tumours may be induced without causing permanent damage to the skin which has to be traversed by the rays before the underlying organs can be reached. The credit of having successfully worked out a technique which enables us to attain that end is wholly due to continental operators. Albers Schönberg, Haenisch, Bordier, the members of the Freiburg school, and others have elaborated techniques which may be safely used.

Whichever method we employ, and this point is so important that the principal of these will be described in detail, it is essential that the work should be done by a skilled radiologist in conjunction with a gynaecologist, and not entrusted to inexperienced workers. Routine detail work must be done in every case if success is to be attained. All cases must not be treated indiscriminately, but a careful selection should always be the rule.

**Indications for Treatment in Fibroma Uteri.**—The indications for radio-therapeutic treatment depend upon the following factors :

(1) *Age of the Patient.*—All authorities agree that patients under 40 years of age should not be treated by X-rays, because before that age the treatment for obtaining an artificial menopause would be too long and tedious. Other factors to be considered at that age are obvious. The upward age-limit is difficult to fix. The patient should be of such an age that her monthly periods still persist, or at all events these should not have ceased longer than a year. It is therefore between the ages of 40 and 52, or at most 55, that radio-therapeutic measures are indicated, though it must be noted that patients beyond this limit have been successfully treated.

(2) *Nature of the Fibroma.*—The interstitial form is the one most amenable to radio-therapeutic treatment, the pediculated or sub-peritoneal variety being better treated by operation.

(3) *Hæmorrhage.*—According to Bordier the most suitable are the fibromata with marked hæmorrhage, *i.e.* cases where the periods have been very copious, with abundant clots, or replaced by veritable hæmorrhage. As a rule after the second cycle of irradiation, the discharges have completely and permanently disappeared.

(4) *Size of the Fibroma.*—Fibroma of moderate volume are more easily influenced than those of larger size, but larger tumours, reaching even to the umbilicus, may be considerably reduced in size. Very large tumours are, however, better suited for operation.

(5) *Hæmorrhage at Menopause* with or without fibroids is easily cured or relieved by radio-therapy.

**Contra Indications.**—Bordier is of opinion that radio-therapeutic treatment is not applicable :

(1) When the fibroma is calcified or presents necrobiotic degeneration.

(2) When myomata are malignant, infected, or gangrenous.

(3) When complications exist such as suppurating salpingitis or pelvic peritonitis.

He also quotes the following results :

After the second or third cycle of irradiation the fibromatous patient entirely loses all discharge, the hæmorrhage as well as any colourless discharge from which she may have suffered. In the same time the volume of the fibroma will have begun to be reduced as early as the commencement of the second cycle. This diminution of volume steadily continues, and after the third and fourth cycle it is often found that the uterus has regained its normal size. It is not at all rare to see a fibromatous uterus, of the size of a fist, atrophy after three or four cycles of irradiation to such an extent that it can no longer be palpated through the abdominal wall.

A large number of cases have been treated on the Continent and in America, and a more limited number have received treatment in this country. From a consideration of the results it would appear that a large percentage of cases received marked benefit, symptoms being relieved, and in many cases the tumour was so reduced that the uterus appeared to return nearly to the normal. How lasting the benefit may be has yet to be determined. At present the patient may be assured that she will receive no damage of the skin, at all events of a serious nature. Superficial reaction may occur in spite of all the care that may be taken. When using the large doses of the Freiburg school, it is possible that deep-seated changes may be induced over which we can have no control. Care must therefore be exercised not only in the choice of case for treatment but in the choice of technique we employ. It is well for the operator to master thoroughly one technique and confine his attention to it.

**Technique for Uterine Myomata and Climacteric Troubles** (*Albers Schönberg*).—(1) The tube must be maintained at a hardness of 6 to 8 Walter, or 8 to 9 Bauer, with a current of 2 to 3 milliamperes.

(2) The focus skin distance should be not less than 38 cm., and a compression diaphragm should always be used.

(3) A cycle of irradiations should be given consisting of a separate exposure on three areas—the centre and each side of the lower abdomen. This is best carried out by giving an irradiation, each of about six minutes, on three consecutive days. The whole cycle of irradiation must never exceed eighteen minutes.

(4) There should be an interval of at least fourteen days between each cycle of irradiation.

(5) A subsequent irradiation must be given only if the skin is quite pale and shows no sign of reaction.

(6) The skin of the abdomen should always be guarded by a thick leather filter.

Six minutes' exposure under the above condition is equivalent to 2 to 2.5 X. This would give 6 to 7.5 X for the three days' cycle, an amount well under the erythema dose of 10 X Kienböck.

**Technique for Uterine Fibroids** (*Haenisch*).—Wehnelt break. Penetration of tube 6 to 8 Walter or 7 to 9 Bauer, and a current of  $1\frac{1}{2}$  to 2 milliamperes. Filter of thick sole leather or 1 mm. aluminium, with an addition of one to two layers of chamois leather.

Each series comprises four sittings, which are given on four consecutive days, preferably beginning just after the menses, a sitting lasting for five to six minutes. The skin focus distance is 36 cm. Slight compression is used by means of the compression cylinder and a loofah pad.

During each series a total dose of 5 to 10 X Kienböck is reached. In the latter stages of the treatment the series often consist of three instead of four sittings. Between the series from fourteen to twenty-one days elapse.

When the tumours are very large, or in special cases when rapid effect is necessary, treat in several directions, *i.e.* on both sides, the centre, and also through the back.

Comparison of various units of measurement :—

$$\begin{aligned} X &= \text{unit of Kienböck Quantimeter.} \\ 10 X &= \text{Sabouraud tint "B" or 5 H.} \end{aligned}$$

**Technique for Uterine Fibroids (Bordier).**—The X-ray irradiation is carried out in a series of cycles, each cycle comprising nine separate irradiations of the median region of the abdomen and the iliac regions. There are thus three ports of entry for the X-rays, one median and two lateral, the cycle of nine irradiations being given each month in the interval between the menstrual periods.

The two most important factors are, firstly, the dose of X-rays, and secondly, the filtration of the rays. Bordier's technique has at last been perfected so that the incident dose—that is the dose falling on the aluminium filter—shall be always the same, and easily measurable. All that remains, then, is to choose the appropriate filter according to the order of series and the precise number of the cycle.

As regards the median area, or port of entry, Bordier adds, always employ the same thickness for the aluminium filter, *viz.* 3.5 millimetres. This region should always be carefully protected, so that the skin may not be injured in case a subsequent operation should be required.

As regards the lateral ports of entry at the flanks, the thickness of the filter will vary from  $\frac{1}{2}$  millimetre to 3 millimetres. The aluminium filter, placed on the abdomen, is connected to the earth by means of a flexible metallic wire. The dose of the incident rays may be measured with great facility by means of Bordier's radiometer. The pastille is stuck on to the filter itself, and the dose to be given corresponds to tint 3 of Bordier's scale, which is exactly equivalent to 5 H. The pastille should be compared with the scale by the light of a match, a candle, a benzine lamp, or other artificial light of slight actinic power.

The Röntgen bulb should always be placed at the same distance from the filter; a convenient distance is the breadth of the hand, the four fingers being interposed between the bulb and the filter. Bordier employs a water-cooled Müller tube 16 centimetres in diameter, regulated so as to emit rays of penetration  $8^\circ$  to  $10^\circ$  Benoist.

*Filtration.*—The following table shows Bordier's formula of filtration for each lateral port of entry of the X-rays on their way to the ovary :

## INCIDENT DOSE ON THE FLANK 5 H

	Irradiation.		
	First	Second	Third
	mm.	mm.	mm.
First cycle . . . . .	0.5	0.5	1.0
Second cycle . . . . .	0.5	1.0	1.5
Third cycle . . . . .	1.0	1.5	2.0
Fourth cycle . . . . .	2.0	2.5	3.0
Fifth cycle . . . . .	2.5	3.0	3.5

The dose incident on the filter being 5 H, and the absorbent power of the filter being known, it is easy to calculate the total quantities received by the right and left flanks respectively during each cycle. The time required to obtain the dose 5 H should not exceed five or six minutes.

During the irradiation of the lateral regions the median region of the abdomen is protected by a strip of lead, the edges of which should extend at least two fingerbreadths to either side of the middle line.

The séances are to be given one each day. There should be an interval of at least three weeks between each cycle. As regards injury to the skin, even at the end of the fourth cycle of irradiations there is only a slight brown coloration; Bordier has in no case seen the slightest sign of radio-dermatitis.

**Freiburg Technique for Uterine Fibroids.**—Gauss and Lembcke of Freiburg employ a different technique; a summary of this is quoted below.

The methods employed consists briefly of a series of exposures given at one sitting, which lasts from two to three hours. These are repeated at intervals of three weeks. Three or four séances are sufficient to end in a complete cure (it is claimed) in a large percentage of cases treated. The chief points are:

(1) The treatment of the abdominal wall. Great care must be exercised so as not to damage the skin.

(2) Many points of entrance are considered necessary. These are arranged so that a maximum effect is obtained on the deeper structures while the skin is not damaged.

The points taken are the umbilicus and the brim of the pelvis. A line drawn across the abdomen at the level of the umbilicus forms the upper limit of irradiation. Thus:

9	5	6	7
10	4	3	8
11	1	2	12

The mid-areas are treated with the tube at right angles to the body,

the lateral areas with the patient turned on the side, and the tube pointed obliquely inwards.

Six areas are marked out on the back and the patient placed on the abdomen, the tube operating from above.

The skin is protected by means of T-shaped pieces of lead 2 mm. thick. These should be covered with lint to prevent secondary radiation effects upon the skin.

Several layers of satrap paper are arranged on the surface of two or more layers of loofah sponge, and the whole is embedded in lint or paper. The Kienböck slip is placed on the skin underneath the above filters. The filter is laid over the area of exposure, and the tube is placed in a specially constructed efficiently protected tube box, fitted with good mechanical movements. The distance between the anticathode and the skin should be 20 cm.

Ten to twelve areas may be treated from the front and six from the posterior aspect. An aluminium filter of 3 mm. thickness is used. The dose to each area should be 10 to 20 X. Taking 18 areas at say 15 X this gives 270 X at one sitting. After-effects must be looked for when using these large doses. The patient should be kept in bed for a day or two after the treatment.

The time taken to obtain 10 to 20 X on the skin will depend upon the hardness of the tube used and the quantity of current passing through it.

At Freiburg the usual method employed is to give five minutes to each area, 5 to 6 milliamperes being passed through a tube of a hardness of 7 to 9 Bauer.

It is not necessary to develop the paper for each dose. The total number exposed should be developed at the end of the sitting, and the total dose can be easily ascertained at a later period. The method of Kienböck gives us a means of obtaining a permanent record of the total dose given.

Specially selected tubes are necessary, and a good supply of tubes must be at hand. These may require to be changed frequently, especially in the early stages of their life. Later on one tube may give several doses in succession. A thorough system of cooling must be employed.

## THE TREATMENT OF DISEASES OF THE BLOOD

Radiations either of X-rays or radium are used in the treatment of diseases of the blood, with in some cases a marked improvement in the condition. It is impossible to deal at any length with all the conditions of alteration in the blood and the associated changes in the spleen and bone marrow. A short résumé of some of the conditions calling for radiation treatment will suffice for the present, particular attention being paid to those which are known to respond to these radiations. The technique used will vary in individual cases. Hard tubes should be employed, and if repeated radiations are necessary, filters should be used.

In the treatment of a condition which is general in its effects and of which the pathology is obscure, or where the morbid changes originate in the spleen, glands, and bone marrow, the rational plan is to treat large areas of the body rather than to centre upon one particular organ such as the spleen.

This plan allows of much larger doses being administered and prevents the occurrence of any local damage, which may easily be caused when one organ or area alone receives the irradiations. In these cases the skin is apt to be seriously damaged and treatment has to be suspended.

On general principles, therefore, it is well to give the splenic area a thorough irradiation and then proceed to deal with other regions. When the spleen is greatly enlarged the skin area over it may be divided into several sections, and each receive a dose in turn. The ends of the long bones may be treated through the surface by using hard tubes and filters. The glands of the axilla, groin, and neck may also be thoroughly irradiated.

*Duration of Treatment.*—At the commencement of treatment a dose may be given twice a week for about six weeks. Care should be taken to change the areas as frequently as possible. Treatment is then suspended for two or three weeks. At the end of that time one or several doses may be given, and the patient kept under observation for another three weeks.

In treating leukæmia, etc., a careful watch should be kept upon the blood, counts being made at regular intervals. A differential count should always be made. Cases which respond well to treatment should be carefully watched over long periods of time, and on no account should treatment be entirely suspended for any length of time. These cases relapse even when regular treatment is carried out, but are less likely to do so when the action is kept up by giving regular doses at intervals of a month or six weeks.

It would appear that when the tissues have received benefit from radiation treatment, they require a regular repetition to maintain the improvement. Patients appear to miss the stimulating effects when treatment is suspended.

**Pernicious Anæmia.**—In this disease the effects of X-rays upon the blood-forming organs, *i.e.* the spleen and the marrow of the long bones, may sometimes be of great benefit. Great care must, however, be exercised in these cases. Stimulating doses are required. Small doses of a penetrating ray at frequent intervals may be beneficial by acting as a stimulant to the blood-forming organs.

Careful and frequent blood counts must be the rule, and if no marked improvement results from a few exposures treatment must be suspended. The fact must be well borne in mind that large doses may precipitate a fatal termination by inducing a toxæmia.

**Hodgkin's Disease.**—This is an affection characterised by a progressive enlargement of the lymphatic glands (beginning usually on one side of the neck) and spleen, with the formation in the liver, spleen, lungs, and other organs of nodular growths associated with a secondary anæmia without leukæmia.

This disease is very responsive to X-ray treatment, and if radiated

sufficiently early in the course of the disease, marked improvement, arrest of progress for a lengthy period, and, in a percentage of cases, cure may result.

The beneficial effect of the X-rays is due to a direct action upon lymphatic tissue and to an effect upon tissue-ferments. The action upon tissue-ferments may be directly a result of the ray action upon the blood cells; consequently in this disease it is well to treat large areas of the body surface as well as the particular group of enlarged glands. A marked diminution in the size of enlarged glands may be induced when only remote regions of the body are treated.

In all these cases it is well to begin treatment by giving frequent small doses, in order to ascertain the degree of response to the radiations before proceeding to give large filtered doses. Should the response be favourable, the more penetrating ray may then be employed in various situations. A dose once a week should be sufficient, several large areas being treated at one time. In most cases a filter should be employed,  $\frac{1}{2}$  mm. to 1 mm. thick.

After a sufficient number of doses have been administered, treatment should be suspended for a time (two or three weeks). After this, treatment should be continuous, a dose being given once a fortnight for several months so long as the disease appears to be quiescent. Should a relapse occur it will be necessary to resume the same or more frequent and larger dosage.

**Leukæmia.**—An affection characterised by a persistent increase in the number of white blood corpuscles, associated with changes, either alone or together, in the spleen, lymphatic glands, or bone marrow. There are two main types, though combinations and variations may occur:

(1) **Spleno-Medullary Leukæmia.**—In this form the changes are specially localised in the spleen and the bone marrow, while the blood shows a great increase in elements which are derived especially from the latter tissue, a condition which Müller has termed "myelæmia." Ehrlich calls this type of the disease myelogenous leukæmia.

(2) **Lymphatic Leukæmia.**—Here the changes are chiefly localised in the lymphatic apparatus, the blood showing an increase in those elements derived from the lymph glands.

In the spleno-medullary form the spleen is greatly enlarged, the organ being in a condition of chronic hyperplasia. There is also marked hyperplasia of the bone marrow.

In the lymphatic form there is a general lymphatic enlargement, which is usually associated with a certain amount of enlargement of the spleen.

It is necessary to describe the blood changes in this disease, but it must be clearly understood that remarkable fluctuations occur both in the relative percentage of cells in the blood, and in the size of the spleen, in cases which receive no treatment. Caution must therefore be exercised in attributing improvements to radiation treatment which may represent only the normal fluctuations of the disease. When thorough radiation treatment is carried out, marked improvements may sometimes be induced, and the spleen often diminishes in size. Bearing in mind the analogy between this disease

and sarcoma, it would appear that leukæmia is really a malignant disease of the blood.

This fact, no doubt, accounts for the ultimate failure to cure in nearly all the cases treated. Relapses occur from time to time which may respond again and again to further treatment, but in the end the disease baffles the remedy.

During the course of treatment by radiations, differential blood counts should always be made, and a rapid fall to normal should be an indication for the suspension of treatment.

*The Nature of the Action of X-rays in Blood Diseases.*—Krauss and Zeigler explain the action as being a destruction by the radiations of the pathological lymphoid tissue. Edouel attributes the effect to an action upon the tissue ferments.

The analogy between this action upon blood cells and that upon the cells of a new growth is striking. In both instances the new cells are being produced at an abnormally rapid rate, and presumably their power of resistance to radiations is much lower than it is when cells are produced at a lower rate, and therefore they are more easily destroyed. Melchener and Wolff found that a spleen, which, after removal from the living body, was exposed to radiations, yielded a leukotoxin, which, injected into a healthy animal, produced a marked reduction in the number of leucocytes, while a similar injection from a spleen which had not been irradiated produced a leucocytosis, increasing the number of white blood cells.

Beclere emphasises the necessity for the continuance of treatment over long periods of time, in spite of an early apparent disappearance of symptoms. He found that under X-ray treatment the blood condition improved, the general health markedly improved, colour was regained, there was a rise in the number of the red cells, and the nucleated red cells disappeared.

Megaloblasts and young cells disappear early, the normoblasts being a little more tenacious. The presence of the solitary myelocytes should correct the hasty impression that the disease has been vanquished, but he has seen cases which had been treated for six years and remained well. Although there are relapses these are frequently ameliorated by further treatment.

Panton and Tidy have made some observations on the results of treatment which are of great value. Treatment by arsenic and X-rays produced in some cases: (1) no alteration in the condition; (2) a remarkable though temporary improvement. The treatment occasionally precipitated the fatal issue. The most interesting blood change observed was the replacement of the typical granular cells by non-granular myeloblasts shortly before death.

In those cases in which marked effects were produced by treatment it is open to doubt whether that effect was beneficial. In some cases treatment was followed by effects the reverse of beneficial. Panton and Tidy emphasise the point that a diminution in the number of leucocytes and size of the



spleen is not necessarily evidence of improvement but may be the reverse.

A drop in the total number of leucocytes with a relative increase in the myeloblasts suggests a fatal termination in the near future, and such an event may result from treatment in a case apparently progressing favourably.

The blood change aimed at is a reduction in the number of leucocytes to a number approximately equal to but not less than the normal, the relative percentage of cells being unaltered. A rapid diminution in the number of white cells, with an increase in the percentage of non-granular, and particularly in the percentage of myeloblasts is an indication that treatment must be suspended. This need only be temporary, for after a time the white cells increase again. Treatment repeated at intervals will help to keep the disease under control. Patients may go on having regular doses at long intervals and maintain fairly good health for years. In all cases the dosage should be controlled by the clinical condition, and blood counts should be made at regular intervals during the course of treatment. This enables a check to be kept on the radiation dose, and indicates whether a long or short exposure is advisable. It may suggest that treatment be suspended for a time. Patients who are taking arsenic internally, or who have recently had salvarsan, should be carefully watched while undergoing radiation treatment. Rapid changes may be induced in the blood of these patients.

## THE TREATMENT OF DISEASES OF THE LUNGS AND MEDIASTINUM

Up to recent times the radiation treatment of diseases of the thoracic and abdominal cavities has received little attention, but a recognition of the marked improvement in the general condition of patients receiving X-ray treatment for deep-seated cancer, fibromata, and other conditions has led to the systematic treatment of all deep-seated disease by X-rays.

**The Enlargement of the Mediastinal Glands** met with in lymphadenoma and primary and secondary sarcoma yields, at all events to a partial degree, to deep radiations.

All conditions of tumour should be treated for a time with X-rays, a thorough technique being used and large doses with hard tubes being given. Marked relief may often be obtained, and the patient's condition much improved.

The thoracic area should be mapped out into divisions of a convenient size, and lead screens employed to protect the surrounding skin. A filter of 3 mm. of aluminium is used, and the tube brought as near as possible to the skin surface. It is best to employ a hard tube, a 10 Bauer if possible, through which a current of 4 to 5 milliamperes is run. Kienböck paper should always be used, and a careful record kept of all exposures for future use.

Ten or twelve exposures may be given at one sitting on one day, followed

up on the succeeding days with as many exposures as it is possible to fit into the thoracic area.

When the front of the chest is treated, the areas are marked out so as to include the intercostal spaces in the longitudinal aspect of the aperture. By this method a percentage of the rays get in through the intercostal spaces. The supra-clavicular areas, anteriorly and posteriorly, may be treated in the same way, and the axillæ should also be irradiated. The posterior thoracic wall should be mapped out and treated in a similar manner.

By using this technique it is possible to get in a comparatively large dose up to or exceeding 100 X on the skin surface in one or two days. The patient should be confined to bed for a day or two after each series of radiations, and a watch kept on the pulse and temperature. A marked reaction may follow, and hæmorrhage may even occur as the result of the reaction to the stimulation, but this slowly subsides.

In the intervals of treatment the patient should, if possible, be in the country, living an open-air life, and tonics and a generous diet should be insisted upon. The result of treatment on these lines is frequently a marked improvement in general health, with a sense of well-being and an improvement in spirits; often there is also relief of pain, and in some cases a gain in weight, and a reduction in the size of the tumour.

**Sub-acute or Chronic Tuberculosis** may benefit from a course of radiation treatment combined with open-air treatment.

**Lymphadenoma** often responds to this treatment to a marked extent, and **sarcomata** are occasionally arrested in their progress for a time at least.

**Endotheliomata** of the lung or pleura are the most likely tumours to benefit from radiations, and secondary carcinoma of a slow growth also appear to improve.

In the future, when it may be possible to use still harder tubes and give longer exposures with a more penetrating ray than has hitherto been done, it may be hoped that greatly improved results may be obtained. This belief is supported by the great improvement which has recently taken place in the treatment of malignant disease generally. It is now possible to influence favourably by X-rays the progress of many cases of carcinomata which a few years ago did not seem to improve at all. This improvement in results is undoubtedly due to the following improved factors in therapy: (1) The employment of very hard X-ray tubes; (2) the employment of fairly thick filters; (3) a considerable increase in the dose of radiations; (4) the employment of many ports of entry; (5) the increased frequency of treatment.

In many cases the results obtained are quite as good as those obtained by the use of radium.

## B. RADIUM THERAPY

### PHYSICS OF RADIUM

By C. E. S. PHILLIPS, F.R.S.E.

When a radium atom has become unstable, most probably through the gradual radiation of undetectable energy by the electrons which it contains, the new condition requires a rearrangement of its constituent parts, accompanied by the sudden expulsion of an electrified atom of helium.

The spintharoscope of Crookes, as well as the more recent methods of Rutherford and Geiger, enable these individual atoms of electrified helium to be counted; they may even be caused to make a record upon a moving photographic film. In this way it is seen that they are not expelled by the radium atoms with perfect regularity. During any given interval of time, however, their number is very nearly constant.

Thus, from a definite quantity of radium there come streams of electrified matter, the particles of which move at about 12,000 miles per second, carrying a positive charge, and constituting the well-known positive or Alpha rays.

It may be pointed out at once that it is the writer's intention to include in this section only data which seems essential for the purpose of describing the broad principles underlying the application of radium to medical work. For greater detail, reference should be made to standard works on radioactivity. It is, therefore, thought unnecessary to dwell at length upon the behaviour of the products of radioactive change which give no rays of therapeutic use, nor has it been considered advisable to attempt any elaborate summary of the various physical properties and actions of radioactive bodies generally.

There is every probability, however, that some better way will be found in the future for utilising medically the great kinetic energy of the Alpha particle, and in view of that possibility, it is proposed to refer more in detail to the properties of this radiation than would otherwise have been necessary.

In any mass of radium some of the atoms are extremely stable, while others are approaching in various degrees the condition which ends in their disruption. The "average life," therefore, of a radium atom means the average of a number of different values, ranging from seconds to thousands of years. It is curious to notice that, in spite of violent atomic disturbances taking place around them, some of the radium atoms should remain so stable, and especially that always the same fraction of them disintegrates at any given period. Experiment has shown this proportion to be characteristic for each radioactive substance, and holds independently of whether the atoms are compact (as in a solid) or widely distributed throughout a solution.

Further, no means has yet been found whereby the rate of disintegration can be modified in the least degree. Reference will again be made to this question when the meaning of the "half-period" and other radioactive constants is considered.

The atoms of all forms of matter may be regarded as minute clusters of still more minute bodies which carry electric charges, some being negatively and others positively electrified.

It is one of the most striking facts in science that the mass of these negatively electrified bodies, as well as the charge they carry, is the same wherever they occur, for they can be driven out of the atoms of many substances and their properties studied. On the other hand, since the residue of an atom which has lost a negative body or electron is no longer neutral, but contains positive electricity in excess, the positive ions are associated with groups of particles and have never been successfully isolated. In general, therefore, their mass is far greater than that of the electrons, and their movements under the same forces are proportionately slower. The electron being only about  $\frac{1}{1800}$ th the size of an atom of hydrogen, it can be realised that since some atoms contain but a few electrons, there must be plenty of room for the movements which modern atomic theory requires in interpreting the results of experiments. When electrons escape from a radium atom they move at a great speed—approaching the velocity of light ( $3 \times 10^{10}$  cm. per second)—and therefore penetrate not only the spaces between the atoms of other substances, but even traverse the atoms themselves. Their course may, however, be bent by a magnet, since they have magnetic fields surrounding them in virtue of their motion and electric charge. And, in addition, they can be coaxed to a greater or less extent from almost any substance by heating or heating down upon it waves of short length, such as those of ultra-violet light or X-rays. It therefore appears from many experiments of this character that all bodies contain electrons. We must point out, however, that the term "radioactivity" does not apply to those substances which require an external stimulus to bring forth a radiation from them. Its use should be exclusively limited to cases where an atom disintegrates *spontaneously*, whether accompanied by the emission of a radiation or not.

It would therefore be inaccurate to describe as radioactive the phenomena of tribo-luminescence, or thermo-luminescence, or the light given out by materials which have previously been strongly illuminated: nor can it be strictly applied to the electrodes of a vacuum bulb in which X-rays are generated.

The deviation of a ray by a magnetic or electric field forms a direct experimental proof as to whether we are dealing with ether pulses or streams of electrified matter. Radiations in the nature of light are unaffected by these means so far as deviation is concerned. The path of Alpha particles, however, is modified very slightly by a magnet, because, owing to the comparatively large mass, the velocity of the positive ions is far less than that of the electrons.

A magnetic field of great strength is therefore necessary for the deviation of Alpha rays. On the other hand, a small magnet will suffice to appreciably affect a stream of Beta particles, and in addition, in the case of Beta rays from Radium salts, owing to their heterogeneous nature (different velocities), a stream of electrons may be sorted out into a kind of spectrum by this means. It also follows that the Alpha and Beta rays are deflected oppositely by a magnet, and tend always to travel in a direction at right angles to the lines of magnetic force.

In virtue of their electric charges, both Alpha and Beta rays are also deviated by an electric field. The methods by which a direct experimental measurement of the velocity of the particles comprising both kinds of rays is made depends, in fact, upon the foregoing reactions.

### Ionisation and Recombination

Now we have seen that the radium atom expels another atom (of helium), and it is important to consider the effect of this positively electrified particle when projected at a velocity of 12,000 miles per second amongst the neutral clusters of other electrified bodies constituting a gas. A gas is chosen because its atoms or molecules can so freely move relatively to one another that if their constituents are split asunder by the inrush of the Alpha particles their regrouping will not occur too quickly to enable the new condition to be in some way detected. As a crude analogy we may picture a bullet fired into a space hung with bags of flour. After the passage of the shot fine dust would fill the air. Some such commotion is certainly produced when an Alpha particle strikes against the atoms of a gas; the latter are split into numerous minute fragments—the electrified dust of atoms—and, in the case of air at normal pressure and temperature, 153,000 electrified bodies, electrons, and positive ions are liberated to move actively in all directions. Many questions of great interest centre round the mechanism by which bodies are detached from neutral atoms through the impact or close proximity of other changed particles. Above all, it has provided a direct experimental method of attack upon the hitherto obscure problem of the constitution of matter.

*Ionisation* occurs similarly when the electrons or Beta particles traverse a gas, and it may also be produced (only in less degree) by the passage of short-wave ether pulses. But it only takes place then if the waves of the radiation are so short that the electrons within the atom can gather energy from them, and thus augment their movements to such an extent that ultimately they become detached, and fly off at enormous velocities in all directions.

The Alpha particles from radium are completely absorbed by 3.5 cm. of air. In other words, beyond this range they are incapable of detection by their electrical effects, since no ionisation of the gas occurs. The range of the Alpha particles expelled by various products of the radium series depends in each case upon the rate at which the product disintegrates.

It must be kept in mind that, during the process of ionisation, the numerous electrified particles set free are, in virtue of their mutual attractions and repulsions, continually *recombining* to form neutral groups again. It is evident, however, that the action of a radiation may be to so disturb the normal arrangement of the constituents of atoms that, while the influence is operative, their usual properties are modified. If, in fact, the density of the radiated substance is relatively great, as in the case of a solid, while the number of atoms breaking up per second is also far more than with a gas, the rate of recombination is also enormously increased owing to the much closer proximity of the molecules. But, on the other hand, some of the changes produced by the radiations are permanent, since the new groupings that arise become comparatively fixed owing to limited molecular movement.

It is therefore interesting to notice, for instance, the change in colour of glasses and other substances under the influence of certain radiations, and to find that after a thorough shaking of the molecules, sufficient to increase appreciably their mean free path, obtained by the application of heat, the original grouping is regained and the colour disappears. Although this refers chiefly to alterations in the physical nature of a substance, many chemical changes are also produced, presumably by upsetting the arrangements of the bonds which unite atoms into definite molecular groups.

It should now be clear from the nature of ionisation that an electrified wire brought into a mass of ionised gas will be diselectrified by attracting

to it ions of the opposite charge, and will repel the others. Thus, negatively charged initially the wire will attract positive ions, and gradually become neutral. A strip of gold or aluminium leaf attached by one end to such a wire will stand out from it when the wire is electrified, and therefore a very simple method of detecting the presence of ions in a gas consists in observing the movement of the free end of the gold leaf when a radioactive body approaches the wire. It is, in fact, the basis of all measurements of radio-

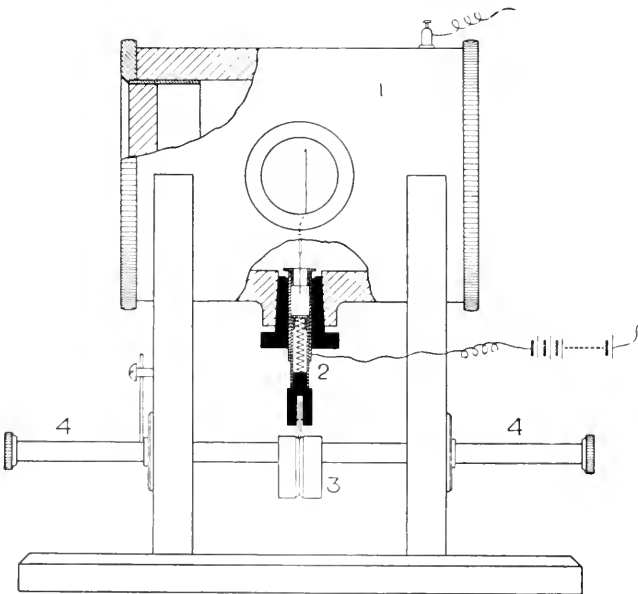

FIG. 220.—Special form of gold leaf electroscope.  
(For description see p. 341.)

observing the movement of the free end of the gold leaf when a radioactive body approaches the wire. It is, in fact, the basis of all measurements of radio-

activity, and the electroscope shown in Fig. 220 is an instrument embodying this principle. Its detailed description must, however, be deferred till later.

## Radium Emanation

The residue that remains when a radium atom has expelled an Alpha particle is no longer radium. It is an atom of a new substance. The property whereby it clung originally to adjacent atoms and in the aggregate

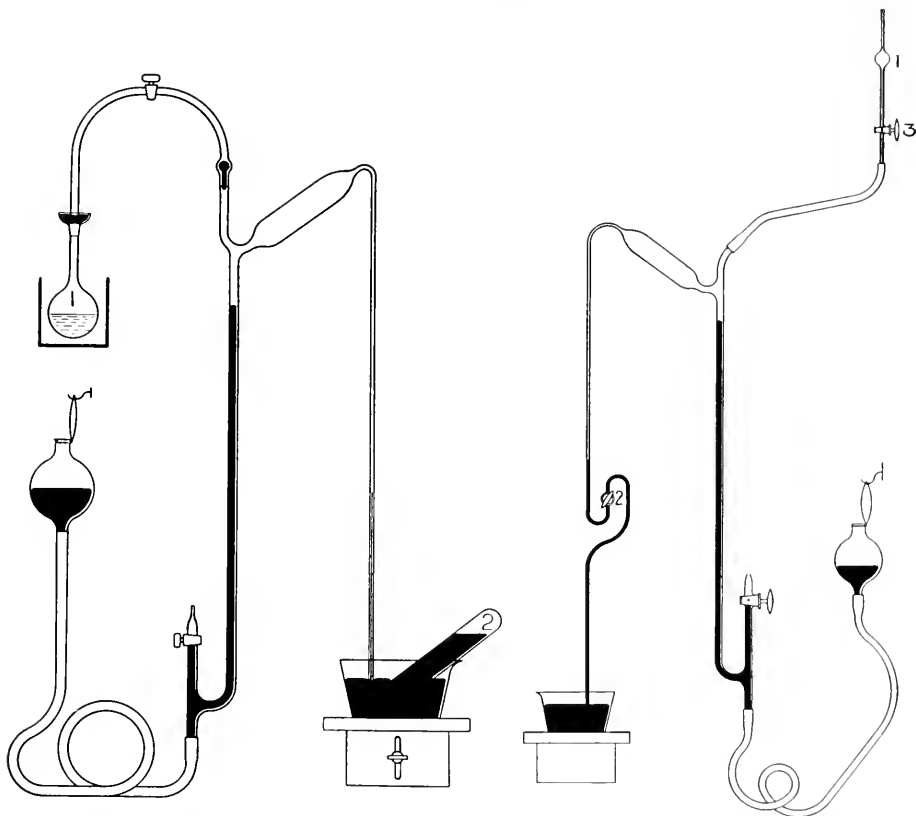

FIG. 221.—Apparatus for pumping off and collecting radium emanation.

FIG. 222.—Combined pump and apparatus for concentration of radium emanation by liquid air.

constituted a solid substance is absent now, with the result that the new atom wanders off and exhibits the characteristics of a gas. It is lighter than Ra, but still very heavy. The atomic weight of the lost helium being four units and that of radium 226.4, the new substance has an atomic weight of  $226.4 - 4$  or 222.4. It has been called "the emanation," and is itself radioactive. Radium emanation can be collected, transferred, and generally manipulated like any other gas, and the apparatus for this purpose is shown in Figs. 221 and 222.

The most convenient way of liberating emanation from a radium salt

is to dissolve it in water strongly acidulated with hydrochloric acid. The solution placed in the bulb 1 (Fig. 221) gradually develops a supply of the gas, which may be pumped off from time to time, and collected by displacement in the tube 2, before removal to the sparking apparatus represented in Fig. 223. Here the mixed gases, hydrogen and oxygen, produced by the decomposing action of the emanation upon the solution are recombined to water by the

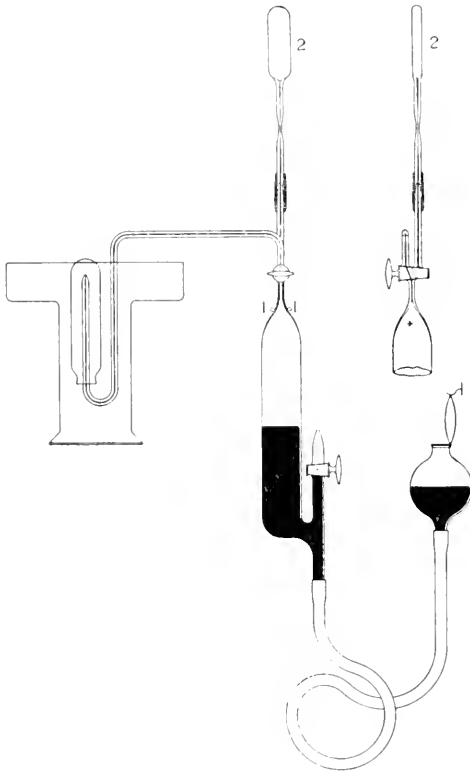

FIG. 223.—Apparatus for charging glass or other applicators with radium emanation after sparking.

passage of a small electric spark between the platinum points 1, 1, and the volume of gas to be dealt with thereby reduced to about one-fifth its original amount. The residue consists mainly of hydrogen, which always occurs in excess, a little water vapour, and the emanation. If we wish, the threeway stop-cock can be turned, and the gas driven up into the flat glass tube 2, also shown in the diagram, which has been previously exhausted by an air pump.<sup>1</sup>

Another method of collecting the emanation consists in condensing it by liquid air upon the inner surface of a small bulb, (1 in Fig. 222). When the bulb shows by its strong luminosity that the emanation is condensed (an operation that only takes a few moments), the pump can be started, and the whole apparatus evacuated. Tap 2 should then be turned off while

tap 3 is left open, and the bulb is withdrawn from the liquid air and held vertically. The emanation will rapidly thaw off the glass, and it may be driven by a rising mercury column into the very small glass tube above the bulb 1, which is then sealed by a flame and removed for use.

The emanation expels Alpha particles, but they cannot penetrate the glass of these tubes, except in very special cases. The expulsion of an Alpha particle, however, causes the residue to coalesce into a further new body called Radium A, which by further consecutive changes rapidly gives rise to the series RaB, RaC<sub>1</sub>, and RaC<sub>2</sub>.

<sup>1</sup> Always lower the reservoir when the mixture has passed over into the sparking tube, so that the gas is rarefied before sparking. In this way all risk of dangerous explosion is avoided.



Now RaC (*i.e.* RaC<sub>1</sub> and RaC<sub>2</sub> taken together) emits not only Alpha particles but also electrons ( $\beta$  rays) and a highly-penetrating radiation ( $\gamma$  rays), consisting of ether pulses of extremely short length. On this account Radium C is of the greatest importance therapeutically. The streams of electrons from it can easily penetrate the thin glass of the tube, but they are stopped by 1.6 cm. of aluminium or .4 cm. of lead. The  $\gamma$  rays, on the other hand, are about a hundred times more penetrating. The above series of changes requires three hours for its completion, and at the end of that time the quantity of RaC has reached its equilibrium value. But from the moment of separation from the parent radium, the emanation itself decays by a process of disintegration till in 3.8 days only half of it is left.

After a further 3.8 days half of what remained is gone, and so forth. It will be noticed that the actual amount which decays is proportional to the quantity present. For instance, if we have two volumes of emanation, one being twice the other, since both must become reduced to half their initial values by the end of 3.8 days, the amount of emanation which disappears from the former is twice what the other loses in the same time. The same *fraction*, however, of the initial quantity

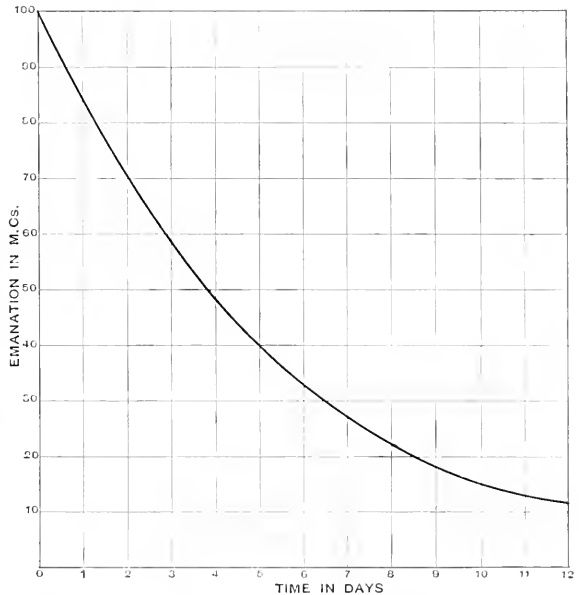

FIG. 224.—Curve showing decay of radium emanation with time.

decays in both cases. An exact analogy exists in the lending of money at compound interest if we can imagine the capital decreased instead of being added to in proportion to the amount at the moment. Thus, £100 lent at 10 per cent interest payable yearly, on this plan, would mean that at the end of the first year £10 must be deducted from the capital, leaving £90 to pay interest on for the next year. At the beginning of the third year the capital would be reduced to £81 after the deduction of 10 per cent on the £90, and so on, the amount deducted being always proportional to the capital. If we plot a curve showing the gradual dying away of the capital in this case, it would be a curve similar in character to that in Fig. 224, which really represents the decay of emanation with time, the quantity disappearing being always proportional to the amount present. This relationship is of fundamental importance in the study of radioactivity. It may be put in another way.

The rate at which the emanation decays becomes less and less in the course of time : that is to say, the actual quantity of gas decaying per unit time is less after some hours than it was at the instant of separation from the parent radium. In Fig. 224 this fact is represented by a curve, the slope of which, though steep at first, gradually becomes flatter. The rate of change of the slope must therefore represent the law governing the decay of emanation with time. Now we know from experiment that the gas decays to half value in 3.8 days, so that calling its initial quantity 100, we obtain a point on the curve at 50. A further wait of 3.8 days gives another point on the curve at 25, and so on. Then a line drawn through all the points forms a diagram resembling the one in Fig. 224.

By taking the difference of any two consecutive ordinates representing say an interval of twenty-four hours, we can measure approximately the amount of emanation decaying during that time, and by trial over the whole range of the curve we find that this value is always the same fraction of the mean quantity of emanation present at the beginning of the interval chosen. The accuracy of the result will clearly be greater if the time interval of an hour or second is selected instead of a day. Thus by this graphic method we can ascertain approximately the value of the constant factor ( $\lambda$ ), which evidently enters into the expression of the law we are seeking, and see in addition that the rate of change of the emanation (slope of curve) must always be equal to  $\lambda Q$ , where  $Q$  is the amount of emanation present at any instant. Conversely, if both the value of  $\lambda$  per unit time and also the initial amount of emanation contained in a capsule are known, we can plot a curve which represents the gradual decay of the gas, and thus ascertain how much remains after any given interval.

But the exact law can be expressed mathematically, and the value of  $\lambda$  calculated, provided we ascertain experimentally the time required for the emanation to decay to some definite fraction (say one-half) of its initial quantity. We have

$$-\frac{dQ}{dt} = \lambda Q$$

Integrating, this gives

$$-\lambda t = \log_e Q + C \quad \dots \dots \dots (1)$$

where  $C$  is a constant.

But if  $Q = Q_0$  when  $t = 0$  then  $C = -\log_e Q_0$ .

Substituting this value of  $C$  in (1) we get

$$-\lambda t = \log_e Q - \log_e Q_0$$

or,

$$-\lambda t = \log_e \frac{Q}{Q_0}$$

Therefore,

$$\frac{Q}{Q_0} = e^{-\lambda t} \quad \dots \dots \dots (2)$$

Suppose now we know that if  $t = 3.8$  days,  $Q_0$  is reduced to one-half its initial amount, the value of  $\lambda$  may be calculated thus :

Inverting (2) and substituting values, we have :

$$2 = e^{\lambda \times 3.8}$$

$$\therefore \log_e 2 = \lambda \times 3.8$$

$$\text{or, } .69 = \lambda \times 3.8$$

$$\therefore \lambda = .18.$$

$\lambda$  represents the fraction of the emanation decaying per day, and the above result is of great importance because it is applicable to the whole range of radioactive substances, each having a characteristic value of  $\lambda$  by which it may be identified.

The equation also represents the law governing the absorption of a radiation in its passage through the tissues or other media, and forms in fact the only criterion by which it can be determined whether a radiation is strictly homogeneous or not. If, for example, by interposing a series of layers of aluminium the rays are not cut down according to the above law, the original beam must have contained a mixture of rays of different penetrabilities.

So far we have only considered the emanation which has been collected and separated from its parent radium. It is evident, however, from the foregoing considerations that the quantity of emanation associated with a given amount of radium will for all practical purposes reach a maximum value within a definite time.

Beginning with the case where all the emanation has been initially driven from the salt by heat or solution, at first the gas will accumulate rapidly, for we have seen that the rate at which it disintegrates is dependent upon the quantity present. If a very small quantity is present the number of atoms disintegrating will be insignificant. Meanwhile the radium is producing the gas at a rate which for all practical purposes may be regarded as uniform; and as it slowly accumulates, the quantity of it which disintegrates in any given time also increases (the fraction of the whole which thus breaks up remaining constant), until a point is reached when a state of equilibrium is maintained, and the quantity of emanation disintegrating per second is equal to the quantity formed by the radium in the same time.

It does not matter of course whether the salt is confined in a large or a small tube, in each case six weeks must elapse before the radium and emanation are in "radioactive" equilibrium.

It is therefore usual to wait for that time before measuring the contents of a tube of radium salt by means of the Gamma rays from the product  $\text{RaC}_2$ , which, by the way, only requires three hours to reach its equilibrium value with the emanation producing it. We are in any case dealing here with very small quantities of material. The quantity of radium emanation in equilibrium with 1 gramme of radium element is only .58 cubic millimetre. But very few institutions can make use of so much radium as this. An operator would be considered fortunate to possess 100 mgrs.

of radium salt for emanation work, and the maximum quantity of radioactive gas that could be obtained from that each month would be  $.033 \text{ cm}^3$ . at normal pressure and temperature; yet this incredibly small volume of material, which would go into a pin's head, is equivalent for a short while as regards Gamma radiation to 100 mgrs.  $\text{RaBr}_2$ .

It is seen therefore, that where it is desired to irradiate diseased tissue from within, the emanation may be confined in small glass tubes encased in a thin pointed platinum cover buried in the growth. The radiation close to such a tube is, however, very intense, and in cases where there is danger of injuring normal tissue, and for external work generally, larger tubes are found very effective. A set of suitable forms is shown in Fig. 229 (page 348). They can be rapidly made at the glass bench to suit special cases, and have the additional advantage of being cleanly and light.

After the emanation has decayed to a value too low to serve any useful purpose, the tubes may be opened and the remaining gas collected, so that when added together sufficient may be obtained to charge a useful applicator.

If it is desired to prepare "radium water" (*i.e.* water which has absorbed radium emanation) for administration in accurate doses, the apparatus represented in Fig. 225 has been found serviceable.

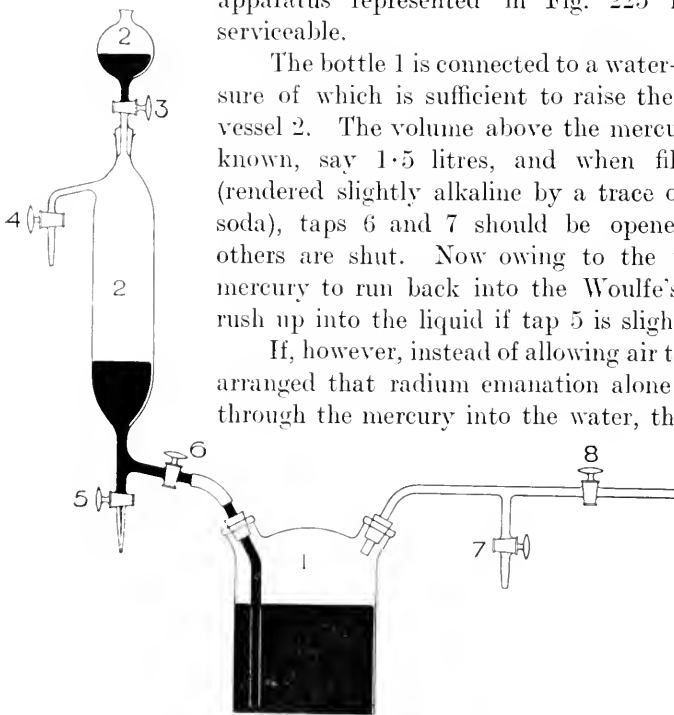

FIG. 225.—Arrangement for the preparation of water impregnated with radium emanation.

taps 3, 6, and 7 with tap 8 closed. It will be noticed that during this very perfect mixing the volume of water does not vary, nor is it exposed to the

The bottle 1 is connected to a water-supply, the pressure of which is sufficient to raise the mercury in the vessel 2. The volume above the mercury in 2 must be known, say 1.5 litres, and when filled with water (rendered slightly alkaline by a trace of bicarbonate of soda), taps 6 and 7 should be opened while all the others are shut. Now owing to the tendency of the mercury to run back into the Woulfe's bottle, air will rush up into the liquid if tap 5 is slightly turned on.

If, however, instead of allowing air to enter here, it is arranged that radium emanation alone shall bubble up through the mercury into the water, the taps may then

be closed, and time allowed for the gas to be absorbed. This process can be greatly facilitated by means of a spray of mercury coming from the funnel on opening

air. The only gas in contact with it is the small bubble of hydrogen containing the emanation.

The solution is thus soon ready to be drawn off from the side tube 4, the water pressure from the main supply forcing up the mercury in 2 and by that means preventing all exposure of the contained liquid to the air, except during the few seconds necessary for the process of bottling.

The bottles used to hold the prepared water are made in sets of graduating size, the volumes increasing in the same proportion as the rate at which the emanation decays. The result of this is that a regular dose may be given twice or so a day for perhaps a week with one set of bottles. (For strength of radium water see p. 343.) The radium solution from which the emanation was pumped is ever giving a fresh supply; the curve showing the rate of growth is the complement of the one just discussed. We can say, therefore, that after 3·8 days half the maximum supply is available; it is evidently more economical to pump the gas off every four days, provided that will give sufficient for our purpose, than to wait a month till the maximum is reached.

In practice, only about 75 to 80 per cent of the emanation may be obtained from a solution in the manner already described. By boiling the liquid more would be obtained, but the risk is too great. The coefficient of solution of emanation is about the same for water and for the blood; salt water takes up less than fresh water, but oils, paraffins, charcoal, and colloid bodies absorb the emanation to a high degree.

It may be well to give here a brief account of the salts of radium now in use, their mode of packing in tubes, and their relative advantages. The element forms an insoluble sulphate. The carbonate is also practically insoluble. To convert the sulphate into a soluble form it may be boiled with carbonate of soda, dissolved in HCl, and crystallised. This gives the very soluble salt  $\text{RaCl}_2 \cdot 2\text{H}_2\text{O}$ . Then there is the bromide,  $\text{RaBr}_2$ , which is difficult to obtain free from water of crystallisation; in calculations, therefore, use the formula  $\text{RaBr}_2 \cdot 2\text{H}_2\text{O}$ .

The following are the values for the weight of radium element in 1 mgr. of the various salts:

Name.	Formula.	Weight of Ra element in Mgrs.
Radium bromide . . .	$\text{RaBr}_2 \cdot 2\text{H}_2\text{O}$	·585
Radium chloride . . .	$\text{RaCl}_2 \cdot 2\text{H}_2\text{O}$	·679
Radium carbonate . . .	$\text{RaCO}_3$	·790
Radium sulphate . . .	$\text{RaSO}_4$	·702

The salts are generally prepared of 50 per cent purity. It is, however, desirable to reduce the volume of the crystals as much as possible, and the purification should, in the writer's opinion, be carried further. This practice (rarely adopted) results in the radium preparation occupying the minimum volume.

The platinum tubes used to contain the salt are generally ·5 mm.

thick in the wall, but  $\cdot 3$  mm. will just carry a screw thread, and if made from drawn tube, will be stiff enough for most purposes. The size of the tube should be such that it is quite filled with the powder, the screw plug being then inserted and gold-soldered in position. It is essential to "tin" the thread with gold before screwing in the plug. If this sealing is not perfectly made, emanation will escape; this may be detected by leaving the tube shut into a box for a few days, and then testing to see whether the interior has become radioactive. When, however, for any reason it is required to place a quantity of radium salt in a somewhat long narrow tube (metal), it may be kept in position by a plug of gold leaf, such as that used by dentists for tooth-stopping. Or, if a flat applicator is needed, Fig. 226 (A), it is a good plan to mix the salt with coco-nut charcoal before filling, for by absorbing the emanation this ensures a uniform radiation from the faces of the tube. For insertion into deep-seated regions lengths of "fine" silver rod should be screwed into the applicator or tubes. "Standard" silver is far too stiff.

A tube of platinum, whose wall is  $\cdot 5$  mm., cuts off 75 per cent of the Beta rays and 4 per cent of the Gamma. Four mm. of lead absorb all the Beta, and 2 mm. are generally safe for a twenty-four hour exposure, where little or no skin reaction is required. Two mm. of rubber, or five layers of lint, seem sufficiently effective in suppressing the secondary rays from the lead. One mm. of lead reduces the Gamma rays by 4.5 per cent.

Unlike X-rays, the Gamma radiation, being practically homogeneous, follows the density law of absorption, so that lead and silver absorb very nearly the same amounts for equal thicknesses. The coefficient of absorption of Gamma rays from  $\text{RaC}_2$  by lead =  $\cdot 51$ , while that for the Beta rays

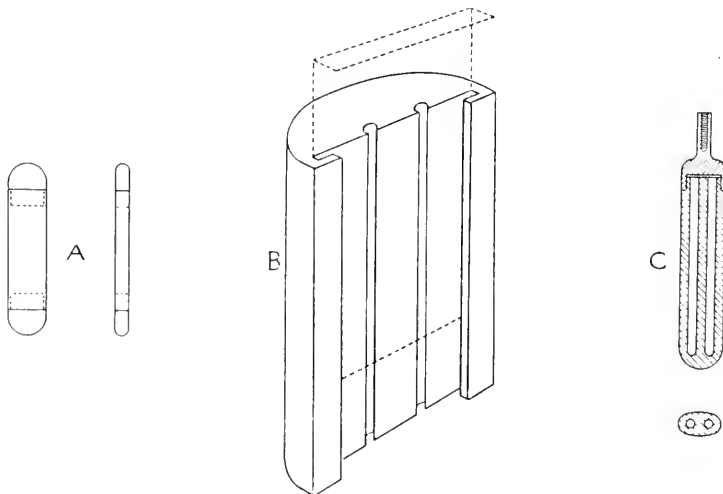

FIG. 226.—Various forms of radium applicators.

varies in the case of aluminium between 13 and 53 (the Beta rays being heterogeneous).

A filter and screen in use at King's College Hospital, and designed by

the writer, is represented in Fig. 226 (B). It consists of a block of silver, cut as shown, and bored out to take two fine tubes of radium salt. The thickness behind the tubes is 1 cm., and each of ten platinum shutters (one is shown dotted on the diagram) can be slid down to screen the radium effectively. An oval section filter, Fig. 226 (C) to carry two tubes is also found to be useful at the same Institution. In order to ascertain the quantity of radium contained in tubes or applicators, it has become necessary to devise methods which may be applied without in any way disturbing the radioactive salts to be tested.

## Measurement

The electroscope shown in Fig. 220 may now be described in detail. It consists essentially of a lead barrel 1 cm. thick (1), provided with lead windows at each end, and glass windows at the sides. A fine rod stands erect within, carrying a piece of glass fibre rendered electrically conducting (or, of course, a gold leaf). This stem is supported by a plug of sulphur, and projects downwards a little, so that the piston (2) can be moved up by rotating the cam (3), and thus connect the leaf stem with batteries. On lowering the stem this connection is broken, the brass guard tube, however, remaining charged.

It is seen that no electricity can leak away from the stem except by ionisation taking place within the instrument, owing to radiation entering by the lead windows. There will, of course, be a natural leak ( $\mathcal{N}$ ), due to slight radioactivity of the air and inner surface of the lead. But if old lead be used, this leak may be reduced to a very small value. The cam is operated by twisting the rod (4) between two stops. The movement of the leaf is read by a microscope. Great care should be taken to see that the air of the room is still when the electroscope is used, or otherwise differences of temperature upon different sides of the instrument will set up air currents within, which vitiate the results. And it is essential to leave the leaf charged for a few hours before making a test. Owing to the curious tendency of insulators to soak up electric charges, time must be allowed for the sulphur to become saturated before beginning work.

The lead barrel being connected to earth, readings are taken when each of the two quantities of radium to be compared stand at some definite distance from one of the lead windows, and a comparison of these results, if one of the radium tubes has been standardised against a known quantity of pure radium salt, will enable the quantity in the other tube to be determined. It would be scarcely appropriate to go into great detail here as to this matter, but it must be pointed out that several precautions have to be taken. The avoidance of air currents, the allowance for "soakage," the correction for the  $\mathcal{N}$  must all be attended to. The charge upon the "guard tube" should remain constant, and for that purpose a set of 200 Leclanché batteries answers well (No. 3 size).

The most important condition of all, however, is that we charge the

leaf stem to a sufficient potential to enable it to attract all the ions of opposite sign as quickly as they form in the gas within the apparatus. A good way to test this consists in measuring the ratio of the ionisation produced by Gamma rays from two specimens of radium salt, one of which weighs about twice as much as the other.

When brought close to the electroscope the ionisation due to the rays from the larger quantity may be so great that all the ions are not caught before appreciable recombination occurs, whereas the lesser tube will give fewer ions, all of which may be attracted to the leaf stem.

It is obvious that the readings then will not give the true value for the ratio of the quantities of radium present. At a greater distance, however, the correct result is obtained, and beyond that point no further change in the ratio should be observed.

By this means experience will show at what rate the leaf should fall to ensure working within a safe margin. When all the ions are caught, the current which traverses the gas in the electroscope is called the "saturation current," and exactly what value it must have in each particular case depends simply upon the potential gradient between the charged leaf stem and the walls of the electroscope. If the stem is charged to 300 volts, the case being always connected to earth and standing with its walls 3 cm. from the stem, the potential gradient is 100 volts per cm., and sufficient for most purposes.

It is not always convenient to use a battery for charging the electroscope, and the device shown in Fig. 227 may often serve instead. It is a

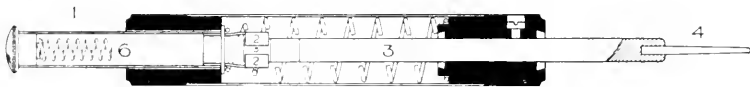

FIG. 227. —Friction device for charging electroscopes.

miniature frictional machine, and produces its charge of electricity by the action of depressing the plunger, 1, to which two small flannel rubbers, 2 2', are attached. The close contact of these as they slide up the celluloid rod, 3, electrifies it negatively, the charge being taken off at the aluminium point, 4, as the rubbers return to their initial position, and are automatically connected to a metal block, 5, previously earthed by contact with the spring, 6. An instrument of this kind is in very general use in a radio-physics laboratory because of its compactness and reliability.

**Units.**—For the measurement of radium salts it is sufficient to express the result in terms of units of weight. But in the case of emanation, since the actual quantities are so small, it has been decided by international agreement to establish a new unit.

We have explained what is meant by the equilibrium value of the emanation. The new unit is based on this principle and is appropriately named after Professor and Madame Curie. The amount of radium emanation in equilibrium with 1 gramme of radium element is called 1 curie. From this the milli-curie and micro-curie follow naturally. But in the case of certain natural "radioactive waters," where the quantities of emanation



are extremely small, another plan is followed upon the continent. Professor Mache has suggested that, if the saturation current produced by the emanation from 1 litre of water amounts to 1 electrostatic unit of electricity per second in a standardised apparatus, the quantity of emanation present shall be called 1000 units. The initiation of a new unit in science certainly calls for courage in these days, when such long lists of them already fill the books of reference. It is in any case desirable to be able to express readily the value of one unit in terms of another, and to adhere as far as possible to the C.G.S. system.

To base any system of measurement upon the arbitrary choice of a special apparatus will appear to many to have its drawbacks, and it is still questionable whether it would not be more advantageous on the whole to adopt the curie and its fractions for the complete range of emanation measurement.

Some confusion appears to have crept into the interpretation of the relationship between the curie and the mache unit of emanation. One authority tells us that 1 curie=3,000,000 mache units, while another gives it as being equal to about 2,000,000 mache units. Taking Professor Mache's own value of  $3.7 \times 10^{-10}$  curie, the correct relationship is 1 milli-curie=2,702,702.7 M.Es. or 2.7 million mache units.

The usual strength to prepare radium emanation water for internal use is 1 milli-curie per litre, but water containing 6 milli-curies per litre has been used in certain cases. The final products of radium, viz. RaD, RaE<sub>1</sub>, RaE<sub>2</sub>, and RaF, are of little or no use therapeutically, and so they need not be referred to here.

It will be remembered, however, that at the outset we expressed the opinion that Alpha rays would be employed to a greater extent if only some effective way of introducing them into a tissue could be devised. The subcutaneous injection of substances holding the emanation, such as refined petroleum, appears to be the most hopeful. Great care must, however, be taken to employ it only in very small doses. A diffusion applicator has also been devised by which radium emanation is allowed to pass into the tissue, either by absorption through the skin or by a process of imbedding. But so far all methods of using Alpha rays are in a highly experimental stage.

### Physiological Action

We have already pointed out that the action of a radiation may so far disturb the normal arrangement of the constituents of atoms that while the influence lasts their usual properties are modified. Now there is no doubt that those who have to do with the application of radiations for medical use are beginning to feel more and more acutely the need of some working hypothesis which will guide their efforts and lead to the accumulation of evidence along definite lines. The practical utility of the far-reaching discovery of radioactivity is certainly held in check at the moment for want of some systematic attempt to work in accordance with a scheme.

The cells of organic bodies consist of complex molecular aggregates, whose ultimate constituents, as far as we know, are the electrified bodies that build up their atoms. We know, further, that when a suitable radiation falls upon these bodies there will be an absorption of energy and an exchange of electrons.

It is, therefore, by action upon the atoms themselves that the radiation primarily exerts its influence. By disturbing the bonds which hold together the intramolecular groups however, chemical changes will also result. Many physiological actions of the rays seem to be out of all proportion to the energy conveyed to the tissues, and moreover, a change once begun appears to continue for weeks after the cessation of the radiation. The action is more pronounced, too, in the case of immature and rapidly-growing cells than in others. We suggest that the chief cause for these effects is the temporary suspension of the normal function of the cells during the time of radiation, and that if the radiation is not intense enough to bring this about, it may, nevertheless, serve to produce, by physico-chemical change, a product which stimulates the growth of the very cell we desire to kill (as well as possibly that of normal tissue).

According to this view, then, there are two distinct actions, viz. the suppression of the normal function of the cells, due possibly to the ionisation of the nuclei, and the indirect effect of the secretion of a product, in the nature of an anti-body, which tends to stimulate growth against the irritating presence of the radiation. If, in the case of a malignant growth, the former can be maintained for a sufficiently long time, the cells die from want of their normal functions, and even the production of the anti-body in excess is harmless, or even beneficial, if it stimulate the normal cells to proliferate. The dead cells are then slowly absorbed, while the normal tissue takes its place.

With the accumulation of careful observation at our disposal, the time cannot be far distant when a broad generalisation will become possible, and the medical use of radiations thereby greatly extended. The comparison of the action of rays upon nucleated and non-nucleated cells, the possibility of producing immunisation by radiations, and many other experiments, should ultimately give important results, and lead to still wider use for radioactive substances in the cure or alleviation of disease.

C. E. S. P.

## THE PRACTICAL APPLICATION OF RADIUM TO DISEASE

In this section of the book it will be sufficient to mention the conditions where radium has been found to possess advantages over X-rays or other forms of treatment.

It should be stated at the outset that radium will produce effects in all the conditions in which X-rays are used, the effect being due to the action of radiations from whatever source they are produced. In the following pages a number of conditions will be described where radium has undoubted advantages over any other form of treatment. When this is not the case, radium should not be employed as long as the price of this element is so prohibitive as it now is. When the two agents are of equal therapeutic value, another factor sometimes influences the choice, namely, the ease with which one or the other may be applied.

The chief points which influence the choice of radium in therapeutics are :

(1) The greater penetration of the Beta and Gamma rays, more particularly the latter.

(2) The convenience with which radium may be applied to several of the internal organs.

(3) The ease with which it can be applied to the interior of a tumour mass, in cases where it would be very difficult for X-rays to produce the same therapeutic effect without great destruction of tissue.

(4) The fact that when dealing with highly nervous patients the application is not nearly so alarming as that of X-rays.

(5) The fact that patients may not be in a condition to be moved to an X-ray department.

### Methods of using Radium

Radium therapy has been practised for several years, and during that time the methods of application have been gradually improved. At first its use was confined to external applications, and these still hold an important place in treatment; the radium was frequently of unknown strength, and also often in percentages much under the stated activity.

More accurate measurements and a higher percentage of purity of the radium salts have led to a great improvement in the technique of radium therapy.

The equipment of a radium laboratory should first be briefly considered, as this is the centre from which all treatment must emanate if it is expected to be on the right scientific lines.

Assuming that we have at our disposal a certain quantity of radium, how is it going to be used to the best advantage? The answer is largely governed by the type of cases to be treated.

The chapter on physics will have acquainted the reader with the active properties of radium. The agent is constantly giving off a gas, the emanation, which possesses the active properties of radium, the only difference being that the decay curve of the emanation is fairly rapid (see curve, p. 335, in section on physics of radium).

Bearing in mind this decay and its time factor, it is possible to utilise the emanation in therapeutics in a variety of ways which will be presently described. For all practical purposes the emanation may take the place of the radium in metal tubes now so frequently used. In order to obtain the maximum value from the supply of radium, it is obvious that a portion at least of the salt should be kept in solution in order that there may be a constant supply of emanation at stated intervals.

The method of drawing off the emanation, already described, may be utilised in therapeutics. The emanation may be used in the following ways:

1. **As an inhalation**, alone or combined with oxygen. Great claims are made in favour of this method, especially in Germany, where regular inhalation institutes are in full work. It is most important when using any of the complicated machines now employed, to ascertain that they actually do contain radium in a proportion strong enough to exercise a therapeutic effect. There can be no doubt that this means of using the inhalation is valuable, but careful calculations must be made in order to get a percentage of emanation of sufficient strength to be of use. The action of radium emanation by inhalation is primarily upon the lungs, and if care is not exercised an injurious effect may be produced. The emanation is absorbed and finds its way into the blood, by which it is circulated freely throughout the body. Its action may therefore be far-reaching, and possibly a great field of usefulness exists in the future for this method.

It is claimed that the beneficial effects produced by radium water baths are obtained through the respiratory organs, the emanation given off from the radium in the bath being inhaled by the patient; it is quite likely that this explanation is a correct one, for it is difficult to imagine any action taking place by way of the skin surface.

2. The emanation may be **forced into water**, and the patient be given a stated dose of this at regular times.

Here, again, a large margin of error must be allowed for, because the emanation slowly decays, so that if it is not at full strength when the water

is first dispensed it will be practically valueless in less than a week ; water impregnated with emanation of radium must, therefore, be given at first only in small quantities at stated times, and in gradually increasing quantity in order to compensate for the gradual loss of activity, which is the result of the decay of the emanation.

The emanation is absorbed by oil, water, and other liquids in definite relative proportions, and any of these may be used as a means of getting the emanations into the system, or it may be injected into the substance of or around a growth.

3. The gas may be passed into glass or metal tubes, or flat **gas-tight**

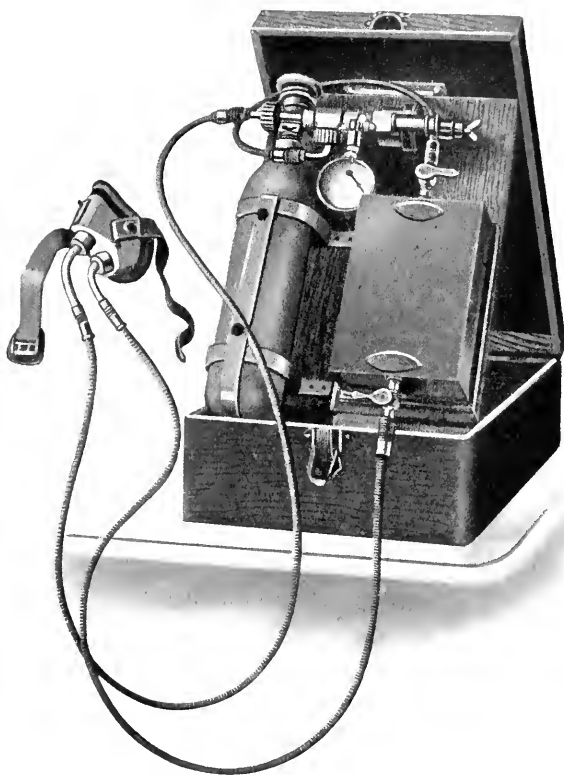

FIG. 228.—Apparatus for inhalation of radium emanation and oxygen. (Radium, Limited.)

**applicators** may be made to receive the emanation under pressure. These may be employed in exactly the same way as the radium tube, bearing always in mind the decay curve of the emanation. Tubes containing emanation may be inserted into a tumour mass, and left for days if desirable.

4. By using a special electrical device the emanation can be **deposited upon metal points** or flat surfaces of metal ; these deposits retain the same activity as the purest radium, but the duration of the activity is much less than that of the emanation itself. The deposit of radioactive bodies on

flat applicators may be used in many ways, as, for instance, for ionisation, a powerful galvanic current being employed to drive them into the tissue. Haret reports a number of cases which have received great benefit by this method of treatment.

Of the many methods of using radium emanation, the one which commends itself most forcibly is that by which the emanation is placed in re-

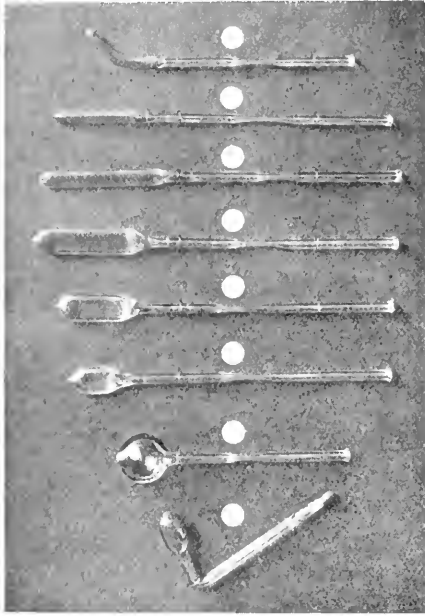

FIG. 229.—Glass applicators for radium emanation.

ceptacles, which can be used in a great variety of ways according to the particular case requiring treatment. The other methods will be referred to again in the section dealing with the treatment of particular diseases. By using a large quantity of radium salt in solution and drawing off the emanation, it is possible to treat a large number of patients by means of specially designed tubes, which can be constructed to suit each particular case. Patients at a distance may receive treatment by means of these applicators, and patients at hospitals may be allowed to go home with the radium emanation applicator, an advantage which is not possible when using the actual radium, on account of its financial value.

5. By means of a liquid-air plant, the emanation can be **forced into small platinum tubes**, which may be inserted into the substance of a tumour.

The parent radium does not depreciate at all noticeably, and is ready to yield up its growth of emanation at stated intervals, 200 to 500 mgrms. of radium in solution yielding emanation in sufficient quantity to treat a large number of patients.

The additional advantage of being able to make a special applicator for the treatment of each case is of great importance. The applicator may be of a suitable shape to allow of the maximum effect being obtained, and being of glass or cheap metal may be destroyed after each application.

It is in the treatment of out-patients that this method is found useful. The applicator is placed in position, and the patient given definite instructions as to the time at which he should remove it.

6. **The Radium Salts.**—This, up to the present, is the manner in which radium has been most frequently or most generally employed. It will be necessary to go into the preparation of these applicators at some length, for it is on a correct assessment of the activity of these applicators

and the quantity of the radium they contain that successful treatment is based.

Bearing in mind the great value of radium at present market prices, it is obvious that no clinique can afford to run great risks of loss of radium by faulty applicators. The French method of putting radium upon linen to form *toiles* is useful and easy of application, but as these *toiles* cannot be regarded as in any degree antiseptic or aseptic, they consequently cannot be used in cases where care in this respect is necessary. The most useful form of applicator for superficial conditions is the flat one, which may be of any desired size and shape. Figures are shown to illustrate radium applicators, the radium being incorporated in a varnish and spread over the metal surface of the applicator (see Figs. 238 and 239). The dimensions most frequently employed for these forms of applicators are :

Square applicators : 2, 3, and 4 cm. square.

Oblong applicators : 2 cm.  $\times$  3 cm. ; 3 cm.  $\times$  4 cm.

The amount of radium salt used is generally 1 centigramme per square centimetre. The activity of the radium salt must also be taken into account. As the strength may vary from 10,000 to 2,000,000 activity, it is obvious that widely diversified effects will be obtained by using the applicator charged with salts at any of the gradations between these two limits.

A convenient form of flat applicator is illustrated in Fig. 231.

The special varnish employed in the manufacture of applicators with fixed salts is made to resist various physical and chemical actions for periods more or less long ; it may be subjected without damage to a temperature of 300° C. or thereabouts ; it resists the action of the following cold or hot liquids and solutions for long or short periods : water, permanganate of potassium of 1 per cent, oxygenised water of 12 volumes, bisulphate of soda of 1 per cent, glycerine, vaseline, bichloride of mercury of 1 per cent.

The use of absolute or 90 per cent alcohol, or of ether, must be avoided ; but a short application of cold alcohol does not appear to have any very serious results.

Screens of nickel, aluminium, lead, silver, or platinum may be employed.

**Tubes with Free Salts of Radium.**—A salt of radium, by choice the sulphate, is enclosed in a platinum tube, the walls of which are of a known thickness, generally  $\frac{1}{10}$  of a millimetre, the external diameter of the tube being at least 2 millimetres. The length and the diameter vary in accordance with the quantity of the salt contained in the tube. For instance, a tube containing 1 centigramme of salts of radium may have an exterior diameter of 2 millimetres and a total length of 18 millimetres. Tubes used more recently are much less in diameter. These narrow tubes are very useful for insertion into the substance of a growth.

The length of the tube is determined by the diameter and the smallest space the radium can be packed into.

The object of the thick silver screen at the back shown in Fig. 232 is to protect the skin surface not receiving treatment. This is used in situations,

such as the axilla, where the skin on the inner side of the area comes in contact with the applicator.

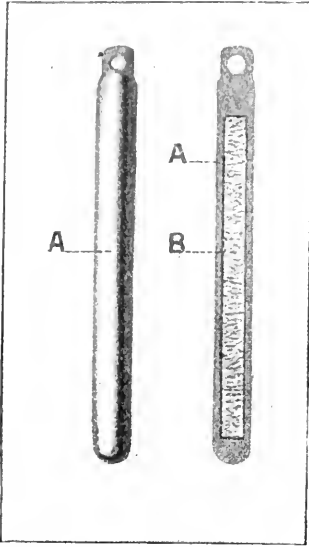

FIG. 230.—The length of the tube is determined by the diameter and the smallest space the radium can be packed into.

A, Outer tube.

B, Space containing radium.

A tube may have an outer case (acting as a screen) fitted to it with a screw cap. The screw is provided in order that the applicator may have a length of silver wire joined up to it for applications in the œsophagus.

In some instances a pointed screw terminal is added to the distal end to facilitate the introduction of the tube into a growth. When using this applicator for insertion into the substance of a growth, it is only necessary to use a local anæsthetic.

The radium in a metal tube is the most useful form in which it is employed and it is capable of being used for application :

- (1) Externally.
- (2) To the interior of the body in such situations as the mouth, nose, throat, œsophagus, rectum, vagina, etc.
- (3) Into the substance of a tumour by making incisions, and inserting the radium tubes into the centre of the mass.

The special methods of preparation of these radium tubes will be described in the section devoted to treatment of diseases suitable for radium therapy.

## Filtration of Radium Rays

The effects produced by a radium application depend upon the quantity of radium used, its strength, and the duration of the exposure. The effect is further influenced by the presence or absence of a filter.

These filters are most important, and a number should always be at hand. For the flat applicators it is necessary to have filters from  $\frac{1}{10}$  of a millimetre to 2 mm., according to the result we desire to obtain. Using 20 mgrms. of a radium salt of 500,000 activity on an applicator 2 cm. square, a marked reaction may be produced on the skin by one hour's exposure. (A thin sheet of rubber or gutta-percha tissue should always be used to protect the radium.) A half mm. of aluminium acting as a screen will delay the appearance of the reaction ; therefore, to get a similar degree of reaction the exposure would require to be longer. When the activity of the radium is greater the effect will be proportionately increased.

The metallic tubes containing free radium require to be used with screens of known thickness, which may be larger tubes of silver or platinum, of a thickness of one to two millimetres of platinum or two to four mm. of silver. When these tubes are not available an efficient filter may be made by



rolling a portion of sheet lead around the platinum tube containing the radium. Silver and lead have equal powers of obstructing the passage of

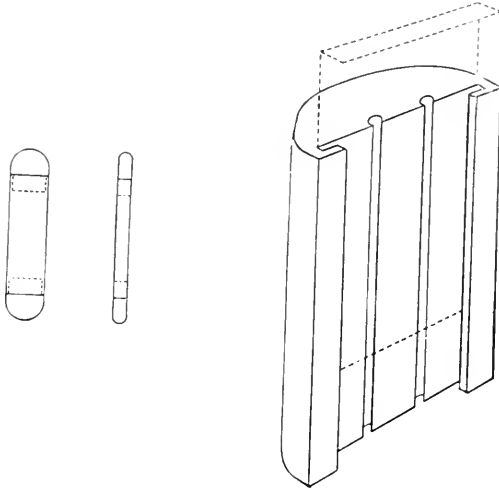

FIG. 231.—Flat metal applicator. Radium is packed in area represented by dotted lines.

FIG. 232.—Showing method of arranging tubes with filters.

A thick silver screen with grooves to take two radium tubes. In front is a groove for platinum filters. Ten of these may be used; each is  $\frac{1}{15}$  mm. thick. The holder has a thick backing of 1 cm. silver, to protect the adjacent skin surface from the rays when in use.



FIG. 233.—Silver screen 1 mm. thick adapted to contain two tubes side by side and fitted with screw terminal.

the rays from the radium, platinum possessing twice the absorption value of lead or silver.

The thickness of the filter to be employed is estimated beforehand according to the effect desired, the quantity of the radium employed, and the tissues to be treated.

*Secondary Radiations from Tubes containing Radium.*—It is not sufficient simply to use a filter for the absorption of the radium rays. It must be borne in mind that the filters also give off rays which are known as secondary radiations; these are injurious to the tissues with which they come in contact, and must therefore be filtered if damage to the tissues is to be prevented. Rubber tubing of a thickness of  $\frac{1}{2}$  to 4 mm. is sufficient for this purpose.

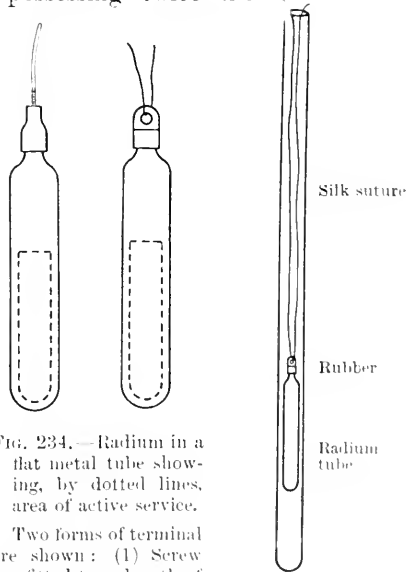

FIG. 234.—Radium in a flat metal tube showing, by dotted lines, area of active service.

Two forms of terminal are shown: (1) Screw top fitted to a length of silver wire; (2) screw top perforated for silk thread or fine silver wire.

FIG. 235.—Radium tube contained in rubber tubing.

*The Influence of Air-space in Filtration of Radium Rays.*—The distance of the radium from the surface of the body also prevents the injurious effects, in other words, air space acts as a filter by preventing radiations of a particular length from reaching the surface. In long exposures twenty or thirty layers of lint should be interposed between the radium tubes and the surface of the body.

### Radium Tubes in the Substance of a Tumour

Attention must be paid to the following points :

(a) The tube must be surrounded by the growth.

(b) When more than one tube is used, the tubes should be at equal distances, so that an equal action be obtained throughout the growth.

(c) The radium tube inside its filter must be enclosed in rubber tubing and closed at each end.

The tube containing the radium must not be subjected to great heat. It must therefore not be sterilised by heat. It may, however, be placed in a solution of carbolic acid for a short time before use. The outer filter may be boiled, and rubber tubing should be sterilised before use. It is important that these measures should be carried out prior to the insertion of the radium tube into the substance of a growth.

### Treatment of Deep-seated Tumours by external Applications

When treating deep-seated tumours it is often necessary to give several exposures to the exterior of the growth, in such a manner that a fairly equal dose is given all over the surface of the mass. If a large quantity of radium is available this could be done by one application; but the majority of operators have only a very limited supply at their disposal, and in such cases it is necessary to give several exposures to cover the surface. The following method will be found useful, a malignant enlargement of the thyroid requiring treatment being taken as an illustration, and 200 mgrms. of radium sulphate in three tubes being available.

The surface of the tumour is mapped out with a skin pencil, each section being numbered. A piece of lead 1 cm. thick is moulded to the surface of the tumour, windows being cut out in this corresponding to the areas already marked. The radium is arranged on the filter to be employed, say 3 mm. of lead, this cutting out practically all of the Beta rays.

The filter is fixed over the window above the area to be treated. The tubes are attached to the surface of the filter by adhesive plaster.

The tubes are so arranged that the maximum of the radiations go through the centre of the filter. The tubes are enclosed in rubber tubing, and thirty layers of lint are placed under the thick lead which has been moulded to the surface of the tumour. Each area receives a portion of radiation from the

exposure of the adjoining one ; the maximum of each area is obtained with the radium directly over its centre, but each periphery gets nearly a half from the exposure of the adjoining area. Thus a certain degree of overlapping must occur, but if the exposures are arranged as above, each area should have a centre of maximum radiation, and the periphery of each receives approximately a full dose from the two adjoining applications. In this way it is possible to get the maximum of exposure all over the surface of a tumour with a fair degree of certainty.

Using 200 mgrms. of radium, and dividing the tumour into, say 10 areas, and giving twenty-four hours' exposure to each, it is possible to administer a relatively large dose, amounting in all to  $24 \times 10 \times 200 = 48,000$  mgrm.-hours. The exposure of the whole tumour would take ten days.

There are **several cautions** to be observed when treating with large quantities of radium.

1. The effect of the earlier exposures should be carefully watched, because if a marked reaction should come on rapidly the subsequent exposures should be postponed.

2. Short of a severe reaction in serious cases the treatment should be persisted in. The beneficial effect may be secured if an adequate dose is given, with practically no skin reaction, but the appearance of a slight reaction is an indication that the maximum skin dose has been given. An interval of time should be allowed to elapse before repeating the exposure over the same area. This should not, however, prevent the treatment from being carried on over other areas in the proximity.

## DOSAGE IN RADIUM THERAPY

The most difficult question in radium treatment is that of dosage. There are many points which require to be considered.

The activity of salts of radium is evidenced by the photographic, chemical, electrical, and physiological effect of its radiation. Thus, if one salt is more active than another, it has a stronger effect upon the substance or tissue with which it is brought in contact ; if, for example, a photographic plate is used, the action will vary immensely with the strength and quantity of radium used. Pure salts of radium, dried and prepared for several months, have a constant radiation, by which they are always identified, and the number of rays produced by a quantity of pure radium salt are actually proportional to its weight. Generally speaking, for equal weight, the salt which is the richest in radium will have the most intense radiation, and its value can be expressed in salts of pure radium.

*Unit of Radiation.*—For the time being the measure which was introduced early in the history of radium therapy has been maintained. Instead of measuring the value in pure salts of radium, it is compared with the standard of activity.

**Standard of Activity.**—In France and other countries metallic

uranium is taken as the standard. Equal weights of radioactive salts and metallic uranium, or the corresponding quantity of uranium oxide spread on the same surface, are compared. The radiation of uranium is taken as unity, when the activity of the pure bromide of radium is equal to about 2,000,000 times that of an equal weight of uranium.

## Relation between the Value of Radium and its Activity

As an example, a table is appended of a few values of pure salts of radium and their corresponding activities :

Value of Pure Bromide of Radium.	Activity.	Value of Pure Bromide of Radium.	Activity.
Per cent.		Per cent.	
0.0025	50	1	20,000
0.005	100	2.5	50,000
0.025	500	5	100,000
0.05	1,000	25	500,000
0.25	5,000	50	1,000,000
0.5	10,000	100	2,000,000

The percentage of pure radium salt in a particular quantity of a mixture of salt and inert matter determines the activity of the particular preparation. When several radium preparations are in use, it is well to test one tube, of say 50 mgrms., and having ascertained its percentage of activity, to regard it as the standard by which the other preparations are estimated. The activity of the radium is estimated by means of the electroscope, and it is customary to base the calculations on the Gamma ray effect upon the gold leaf of the electroscope. For this purpose it is necessary to absorb all the Beta rays before the Gamma rays can be dealt with. This is easily done by interposing a layer of lead 1 cm. thick between the electroscope and the tube of radium. Placing the radium at a given distance, the rate of fall of the gold leaf is watched and timed. Another and stronger tube is then placed on exactly the same spot as the first tube. The reading of the scale indicating the fall of the leaf is again taken, and it is a matter of calculation to estimate the activity of the second tube of radium.

When it is necessary to estimate the activity of emanation, an emanation electroscope must be employed. This is also useful when dealing with substances and fluids which have become radioactive, such as water, urine, etc.

**Age of the Salts.**—Immediately they have been prepared, salts of radium give out only a slight radiation, which consists entirely of the Alpha rays, the radiation increasing gradually, until its maximum constant value is attained at the end of one or two months. This is a point which should always be kept in view when dealing with salts of radium which have been freshly prepared. These preparations may be used, but the calculation of the dosage must be carried out for each preparation. It is useless to compare these preparations with matured ones, from the point of view of therapeutic effect.

**Variation of Activity.**—If salts of radium are enclosed in carefully sealed receptacles, they attain a radiation which always remains constant.

Various causes, however, may modify the constancy of radiation :

- (1) Exposure of the salts to the atmosphere.
- (2) Absorption of moisture.
- (3) Dissolution.
- (4) Increase of the temperature of the atmosphere.

In order, therefore, to maintain a constant radiation, these several factors must be taken into account.

Radium enclosed in metal tubes must be carefully sealed in order to obtain the maximum effect. Each tube should be carefully tested to detect any emanation leak, which may lower the activity of the preparation, and in practical therapeutics lead to serious errors in dosage and effect upon tissues.

**Dosage of Emanation in Solution.**—The solution most frequently used is water, the emanation being mixed with it in a definite proportion. In mixtures prepared in the laboratory, 1 milli-curie to a litre of water is a usual strength. This preparation is used for drinking. In special cases the strength may be greatly increased.

If the solution cannot be measured in electrostatic units, the testing of small quantities of emanation—as, for example, in mineral springs—results in very small fractions. In order to obviate this, Professor Maché of Vienna proposed to multiply this fraction by 1000.

**Maché Unit.**—This unit is so convenient that it is made use of at all the well-known spas (where the activity of the water is very low), and by many specialists of radium therapy upon the Continent, who all use the Maché unit for the dosage of emanation.

**Dosage when using Flat Applicators.**—This will vary with the tissue to be treated and the quantity of radium present in the applicator.

The physiological effect produced upon the tissue will become a practical factor in the calculation of the dose. It is well to determine beforehand the degree of activity by means of the electroscope, and then to apply the applicator for a given time to the surface of the skin in a healthy subject ; or, for experimental purposes, an animal may be used. The effect may take some time to appear, so the exposure must not be repeated until time has been allowed for reaction to manifest itself. Having ascertained the reaction time for healthy tissue, it is easy so to regulate the exposure in diseased conditions as to produce the degree of action required. Thus, in simple conditions such as cheloid, *nævi*, etc., it is only necessary to produce a mild degree of reaction, and keep it up by repeated exposures at stated intervals to get a cure, while for rodent ulcer, epithelioma of the skin, etc., it is sometimes necessary to produce a degree of necrosis of the tumour mass before a beneficial result can be looked for.

Practical experience in the use of these applicators is therefore a *sine qua non* for every radium therapist.

**Dosage when the Free Radium is contained in Metal Tubes.**—Practically all the effects produced by the flat applicator may be obtained

when radium tubes are used. Each tube has a number of filters fitted to it, ranging from  $\frac{1}{2}$  mm. to 3 mm. ; these filters may be of silver, lead, or platinum, the latter being the best, because it has a greater density than the others, and consequently occupies less space. This is very important when tight strictures of the œsophagus or diseases of the bladder or urethra require treatment.

The small tube in which the radium is sealed is generally  $\frac{2}{10}$  to  $\frac{5}{10}$  of a millimetre thick, so if superficial areas require treatment, a short exposure of a half to one hour, with the radium tube enclosed in a thin rubber one, should suffice to produce a mild degree of reaction. Should a deeper effect or a surface effect free from reaction be desirable, then a thicker filter may be employed, and the exposure prolonged. In all these instances it is the Beta rays (all but the softest) and all the Gamma rays which are used. In some chronic conditions, or in cases of widespread disease, it is necessary to get deeper effects, and the greater quantity of Beta rays are cut off, so that only the Gamma rays are employed. In such cases thicker filters are necessary, 2 mm. of platinum or 4 of lead or silver cutting off practically all the Beta rays.

When using the Gamma rays entirely, the exposure must be greatly increased, because the percentage of Gamma rays given off from a quantity of radium is very small (about 3 per cent).

In order to get a physiological effect upon the tissues, long exposures are required, and these will vary with the quantity of radium present and its distance from the tissue requiring treatment. The Gamma ray effect upon the skin is practically negligible when proper precautions are taken within normal limits of exposure. Exposures, with large quantities of radium in well-filtered doses, may be given up to twenty-four hours without damaging the skin. In some instances, where there is ulceration of the surface of a growth, the skin factor in exposure ceases to exist, and then much longer exposure to the surface of the growth can be given, because this surface will bear much longer radiation, and in many instances it is desirable to hasten the ulcerative process. The expression of the radium dose in accurate terms is a matter of considerable difficulty.

We have already dealt with the two methods of expressing the dose in the case of emanation, namely, the milli-curie and the Maché unit.

**Unit of Milligram-Hours.**—Dawson Turner has introduced an expression of dosage which is thoroughly practical for ordinary use, with certain reservations. He takes the quantity of radium used, and multiplies it by the number of hours representing the time factor of exposure. Thus, 24 hours multiplied by 200 mgrms. represents an exposure of 4800 mgrm.-hours. This takes no account of the activity of the radium used, which may vary from 500 to 2,000,000 activity, nor does it take into consideration the distance of the applicator from the surface undergoing treatment.

It would be better to include the activity (a note being taken of it in all exposures), the time of exposure and the quantity of radium, the thickness of the filter and the distance from the periphery. Thus a record of all exposures should include :

- (1) Time, say, 24 hours.
- (2) Quantity of radium, 200 mgrms.
- (3) Activity of radium, 2,000,000.
- (4) Thickness of filter, 2 mm. platinum.
- (5) Distance from periphery, 5 centimetres.
- (6) Known physiological effect upon healthy skin.

## RADIUM IN GENERAL DISEASES

While great claims are made by many authorities of standing as to the efficacy of radium emanation in the treatment of many intractable diseases, it should be pointed out that a great deal of thorough investigation is neces-

The apparatus consists of two vessels, *B* and *F*. Insoluble sulphate of radium is placed in the small receptacle *C* in the vessel *F*.

In order to use the apparatus, the stopper *b*<sub>1</sub>, with the vessel *B*, is raised. The vessel *F* is then filled with the water or other liquid which is required to be rendered radioactive. The cork *b*<sub>2</sub> is replaced, and after having removed *b*<sub>1</sub>, the vessel *B* is filled with the same liquid, and *b*<sub>1</sub> is replaced.

The emanation, which is given off slowly from the salts of radium, is absorbed little by little by the liquid in the vessel *F*, and as this is drawn off by the tap *R*, it is replaced by a corresponding quantity of liquid from *B*, which runs through the tube *T*<sub>2</sub> and emerges under the receptacle *C* by a little hole provided for this purpose. The air can enter *B* by the water tube *T*<sub>1</sub>, but it cannot come out.

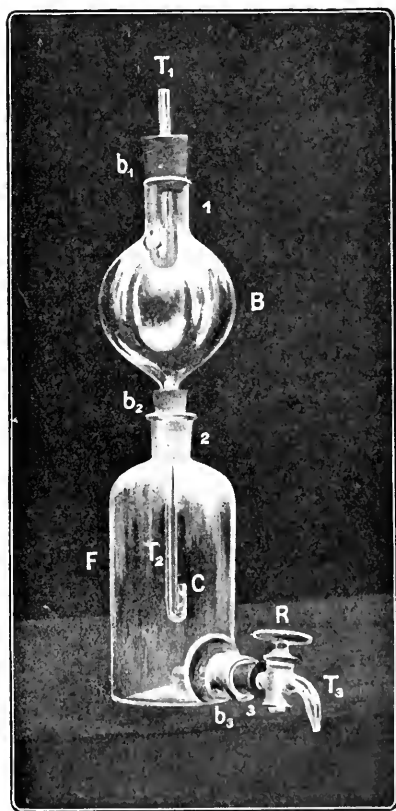

FIG. 236.—Radiogenic. (Siemens.)

sary before these claims can be recognised as of value in a number of these diseases. The chief benefit obtained by patients after taking emanation in solution appears to be a feeling of well-being, and a gradual improvement in the general health.

The blood-pressure appears to be reduced, though, when careful

observations are made on the blood-pressure of patients taking radium emanation, a permanent reduction in it is not easily detected. The patients so treated are generally visitors to well-known health resorts, and while residing there are under dietetic and hygienic conditions which are not so faithfully carried out under other conditions. It is possible that the wholesome *régime* of these resorts, early hours, and restrictions in food and drink are contributing factors to the general improvement; nevertheless there are cases which have benefited from emanation treatment in their homes, while conversely there are many others which do not seem to improve at all.

While patients suffering from general diseases, such as gout, diabetes, and arteriosclerosis, are perhaps best treated at a recognised spa, it is possible to treat such cases in hospital or in their homes. Hospital treatment is the better method, because then it is possible to have the patient under control, and all contributing factors may be considered, and experimental investigations carried out. These observations should be carried out on a large scale, and an opinion on the value of radium emanation in these diseases reserved until it is possible to compare a large number of statistics.

The strength of the emanation employed must be known, and the daily quantity given measured. Such observations can only be carried out in a hospital or institution which has the necessary accommodation, and a fully equipped laboratory, where physical data may be standardised, clinical observations made, chemical and bacteriological investigations carried out, and the whole correlated in order to give the information needed. It is satisfactory to know that these conditions are now existent in several institutions, and that a great deal of research work is going on, which when published should go far towards establishing radium as a therapeutic agent of known and proved value.

The administration of radium emanation solution of a strength of not less than 1 milli-curie per litre to patients suffering from chronic arthritis, from whatever cause it may be due, is often followed by marked improvement in the condition of the patient. Cases treated comparatively early in the course of the disease benefit more readily. The condition of the joints is also of importance. The periarticular variety is the most likely to respond. When there are marked cartilaginous and osseous changes present, little permanent improvement need be looked for. When limitation of movement is due to changes around the joint, and these are not at an advanced stage, some improvement is almost certain to follow. Pain is lessened, the grating in the joint on movement is not so marked, and the muscular and the general tone improve.

## RADIUM IN DISEASES OF THE EYE

Mackenzie Davidson has called attention to the marked effect of radium in diseases of the eye, trachoma, conjunctivitis, and catarrhal folliculitis.



Short exposures are recommended, and the radium should not be screened to any extent. The radium enclosed in a glass tube, or very thin metal filter, is the best form of application, and a few minutes' exposure is all that is necessary. Each case must, however, be treated on its merits, and if short exposures do not produce the effect wished for the time of exposure must be increased.

Rodent ulcers in the neighbourhood of the orbit require special treatment. When situated on the eyelids, the eyeball must be protected when a long exposure is contemplated. A sheet of lead, rubber, or lead enclosed in gutta-percha tissue is moulded to the surface of the eyeball, and placed under the lid to be treated. The applicator is strapped in position for the necessary time.

It will be found that comparatively long exposures may be given when these precautions are taken.

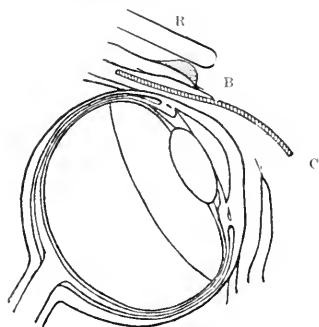

FIG. 237.—Application of radium to the eyelid.

- R. Radium tube.
- B. Growth on upper eyelid.
- C. Lead rubber placed under eyelid to protect the eyeball.

## RADIUM IN DISEASES OF THE EAR, NOSE, AND THROAT

In these regions, owing to the scarcity of the supply of radium, and the consequent difficulty of obtaining sufficiently large quantities, its use has been restricted to malignant disease. But it is probable that in the future a large field of usefulness will be found in the treatment of simple inflammatory lesions. In the region of the ear, nose, and throat it will be found extremely useful as a therapeutic agent of great potency, and probably when radium has found its level in the treatment of malignant disease, some of its therapeutic properties will be directed towards the cure of these simpler diseases.

Granulation tissue readily yields to radiation treatment. Hæmorrhage can be controlled, and when a suppurative condition exists, the discharge may be greatly lessened, and eventually dried up. Chronic inflammatory thickenings will slowly subside under properly estimated radiation dosage. Tubes of emanation can be readily moulded to a suitable size for introduction into the ear, nose, and throat.

Papillomata of the vocal chords have been successfully treated. Chronic suppurative conditions of the ear with extensive formation of granulation tissue will slowly subside, and a return to the normal follows.

A good deal has been written on the treatment of deafness by radium. A considerable experience of the action of both X-rays and radium leads one to state that the percentage of cases which show any definite improvement is remarkably small. This is not surprising when we consider the condition of the parts in the majority of the cases of chronic deafness. Now and again a case which is suitable may show a good deal of improvement,

but any permanent good result must not be expected. In the majority of cases of chronic deafness the hope of improvement through the use of radium should not be held out to the patient. The treatment of such cases can only bring discredit upon the agent employed.

## RADIUM IN THE TREATMENT OF EXOPHTHALMIC GOITRE

It is to be expected that radium should exercise a beneficial influence over this disease. The undoubted success of X-ray treatment led workers to experiment with the radiations from radium. When X-rays alone are used the hard filtered ray appears to be the most useful. Radium may be combined with this either together or alternately. When a patient is too ill to be moved daily to the X-ray room, radium may be applied while he is resting quietly in bed. A prolonged exposure is necessary, extending into several hours, and depending on the quantity used. Using 100 mgrms. with 3 mm. of lead filter, twelve hours to each side of the enlarged thyroid gland should suffice to produce marked improvement. The exposures may be repeated in from three to four weeks. After one or two applications a marked diminution of the pulse rate is obtained, this being followed by an improvement in the general condition of the patient. Several exposures at long intervals should be given after the symptoms have improved. Radium may be used when all other remedies have failed. Dawson Turner has recorded a number of cases treated by radium which are encouraging.

## MALIGNANT DISEASE OF THE THYROID GLAND

Radium also plays an important part in the treatment of enlarged thyroid: malignant disease, especially sarcoma, may yield to radium; apparently inoperable cases may be rendered operable, while an improvement in the condition of the patient is almost invariable. The gland diminishes in size, distressing symptoms are relieved, and in some instances the growth diminishes greatly in size. The technique in these serious cases is different from that in cases of simple enlargement. Large quantities of radium must be used, long exposures should be given, and the whole area of the growth and the lymphatic distribution carefully treated. In one case successfully treated, 205 mgrms. of radium bromide filtered through 3 mm. of lead at a distance of 3 inches from the skin were left in position for seventy-two hours, spread over three areas, taking in all the enlargement. The enlarged gland slowly subsided. There was no superficial reaction at all. In three months nothing could be felt of the tumour, except a slight thickening on the right side of the gland. From a consideration of the results obtained in a large number of cases of enlarged thyroid with constitutional disturbances, the conclusion has been arrived at that radium offers a prospect of greater and quicker benefit than when X-rays are used. It is, moreover, easier to apply, and the dosage may be given at longer intervals.

## RADIUM IN THE TREATMENT OF DISEASES OF THE SKIN

Many of the diseases of the integument respond to radium treatment when other remedies have failed. When the lesion is superficial, it is best to employ the flat applicators. When deeper effects are required, it is necessary to use the Gamma ray with filters. The conditions which are peculiarly responsive to radium are occasionally those which do not give good results with any of the other agents used. Vascular naevi, hairy moles, warts, and rodent ulcer respond well in most cases. Chronic eczema, psoriasis, and other diseases of a like nature readily respond to radium treatment. In place of the flat applicators prepared in varnish, a glass applicator of the requisite shape may be used. This is charged with emanation, and may be applied directly to the skin without a filter, or simply wrapped in a piece of gauze or lint. The advantage of this form of applicator lies in the fact that it can readily be disinfected, and can be repeatedly recharged when required. These glass applicators may be made in a variety of shapes to suit particular cases.

The exposure varies with the quantity of radium used, its degree of activity, and the filters employed. Consequently the estimation of the exposure is always a matter of difficulty.

When large areas have to be treated, it is necessary to continue the exposure over the whole surface by moving the applicator after the adequate exposure has been given. A certain degree of overlapping occurs, but if



FIG. 238.—Circular applicator suitable for the treatment of superficial skin lesions. (Armbrecht, Nelson & Co.)

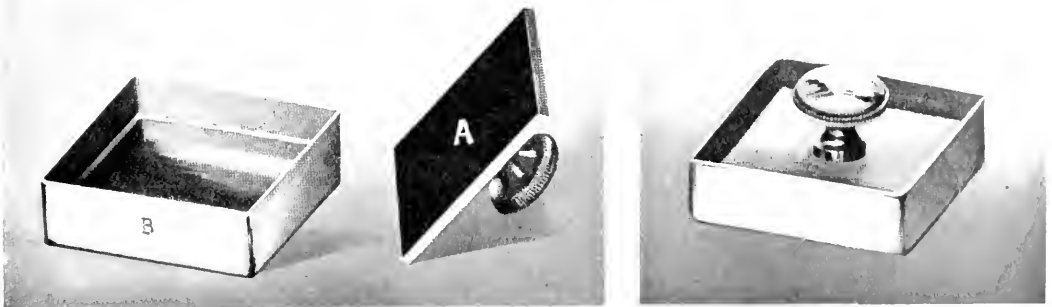

FIG. 239.—Applicator in box. (Siemens.)

This form is particularly useful in the treatment of superficial skin lesions.

the applicator is kept at a distance from the skin by means of several layers of lint, the danger of an overdose to a particular area is greatly diminished.

**Psoriasis.**—Other methods, notably X-rays filtered, give good results. The technique is similar to that employed in chronic eczema. When the radium is enclosed in platinum tubes, the same procedure is necessary, but it must be remembered that in this case a hard ray is being employed, because  $\frac{1}{3}$  to  $\frac{1}{2}$  mm. of platinum (the average thickness of the tubes used to hold the radium) is known to cut off a large percentage of the Beta rays as well as the Alpha rays. To obtain the same area of action as when the flat applicators are used, two or more of the small tubes may be employed, longer exposures being necessary. When using unscreened applicators the exposures will be short, and given at frequent intervals on several successive days. Then an interval of two or three weeks is allowed to elapse before treatment is resumed. This disease is apt to recur at long intervals of time, and several series of treatment may be required.

**Eczema.**—The use of radium in the treatment of these conditions must necessarily be limited to cases which are circumscribed, *e.g.* chronic cases which have resisted all other forms of treatment may receive the stimulus necessary to start the healing process. Flat applicators or tubes may be employed, the exposures varying with the filtration. A flat applicator containing 5 mgrms. of radium, spread over a surface of 2 by 1 cm., will give a marked reaction in from forty to sixty minutes. One application may lead to a marked improvement, though several will be necessary in most cases. Shorter exposures will frequently give real improvement, and these should be repeated at intervals of several days, until a slight superficial reaction appears. When this subsides the condition gradually improves. Treatment should be repeated in a fortnight to three weeks' time, and the case should be kept under observation for several months, in order to check the earliest appearance of a recurrence.

**Nævus.**—Radium possesses a great advantage over other methods of treatment in that its use is painless, and that there are no distracting noises from active apparatus. In children this is important. Nævi may be treated in young infants, the applicator being strapped in position and left for the required time. Further, applicators may be made to fit angles or may be inserted into the cavities of the body or into the interior of an ulcerated cavity or the substance of a growth.

In treating nævi it is necessary to give frequent exposures to the part. After a time, usually a week or ten days, reaction of the surface appears. This may be all that is required, the resulting changes from the inflammatory processes induced in the tissues leading to a disappearance of the vascularity. Should the application not be sufficient to induce these changes it must be repeated. The results obtained cannot be surpassed by any other remedy, and the process is quite painless, a most important point where young children require to be treated. The resulting scars are soft and flexible, and in time the skin takes on quite a normal appearance. The time required for thorough treatment is sometimes a drawback, but if the treatment is carefully carried out the result amply repays the trouble taken.

It is a good routine method to begin treatment in these cases with

unscreened applicators, and give short exposures. Time should be allowed between the exposures to determine the degree of reaction. It is most important not to overdo the exposure, because if this occurs troublesome telangiectasis will follow. If this happens it may be necessary to treat the condition with electrolysis, or better still, the point where the dilated vessels appear may be treated with a diathermy needle. Very good results will follow these applications. In some cases it is better to treat these conditions at once with electro-coagulation.

Nævi may be classified clinically as follows :

1. *Flat Superficial Nævi*.—These respond well to radium treatment. In selecting cases, the deciding factor is the degree of vascularity. If the parts blanch well when pressure is applied, the probability is that the response to treatment will be good.

2. *Capillary Nævi*.—These also respond well, but before beginning treatment with radium other methods should be carefully considered, as carbon dioxide snow, electrolysis, or diathermy are all very efficacious.

3. *Port Wine Stains*.—This variety is not at all easily treated. The stains respond slowly, and require repeated treatment, and often in the end the result is not good. These remarks apply, however, to any other line of treatment.

4. *Cavernous Nævi*.—As a rule, these respond very well. Filtered rays should be employed, and the exposure may be given at one sitting, or if more convenient it may be divided into several of two hours' duration on successive days. Reaction on the surface is not desirable, and can be avoided by adequate filtration.

**Superficial Papillomata (Warts)**.—These may be successfully treated in nearly every case if the dose is accurately estimated. They tend to reappear if treatment is discontinued too soon. An exposure of one-half to one hour with an unscreened apparatus will cause reaction and lead to a gradual disappearance of the wart. The tendency is for recurrence, and the radium exposures may be repeated when necessary.

**Lupus Erythematosus**.—An improvement in this condition may follow radium treatment, but the exposures require to be continued for long periods and at frequent intervals. X-rays and the mercury-vapour lamp often give quite as good results.

**Lupus Vulgaris**.—This is a condition where many methods of treatment may require to be used. There are cases where radium appears to be the best of all; others respond to X-rays, and others again to the mercury-vapour lamp. When the disease is situated in the neighbourhood of the nose, radium is the most useful agent, because it can so conveniently be applied to the interior. The screened rays appear to act best, but in some cases an emanation tube with a rubber tube over it gives excellent results when long exposures are given.

**Cheloid**.—Extensive cheloid is a condition which slowly responds to radium treatment. The exact line of treatment must be determined for each individual case. Radium of low-grade activity is used on flat applicators without other filtration than that of the varnish and a thin layer of

gutta-percha tissue, the latter being employed mainly to protect the surface of the plaque. The whole of the scar tissue should receive an equal amount of radiation, and care should be taken that the edges of the cheloid and the adjoining healthy tissue are also treated. Until the operator knows the activity of the applicator, it is well to give a preliminary exposure over a part of the cheloid for, say, an hour, and then to wait until reaction shows itself. Having thus ascertained the necessary degree of reaction, the whole of the scar tissue can be radiated, an equal exposure being given to every part. A moderate degree of reaction is necessary, and treatment should be suspended until this has subsided. The exposure should then be repeated, the duration of time being increased or diminished according to the results obtained from the preliminary exposure.

When the radium is enclosed in platinum tubes the procedure is the same, but in this case it must be remembered that a harder ray is being employed, because  $\frac{1}{3}$  to  $\frac{1}{2}$  mm. of platinum (the average thickness of the tubes used to hold the radium) is known to cut off a large percentage of the Beta rays as well as all the Alpha rays.

To obtain the same area of action as when using a flat applicator, two or more of the small tubes may be enclosed in a larger applicator, thicker on one side than on the other; such an applicator is shown in Fig. 232. The time of exposure must be proportionately lengthened according to the thickness of the radium tubes, and the external filter employed.

With applicators having tubes of a thickness of  $\frac{1}{2}$  mm., the exposure may safely run into four to six hours. With a filter of 1 mm. the time might be extended to six or eight hours, and with a filter of 2 mm. or more the exposures may be up to twenty hours.

In all these instances the employment of two or more layers of surgical lint is recommended, this also serving the purpose of preventing damage from secondary radiations produced in the filter.

**Leucoplakia.**—This condition responds readily to radium. In situations such as the mouth, tongue, etc., radium is probably the best therapeutic agent which can be employed, largely on account of the ease with which it can be applied to the leucoplakial patch. This condition is frequently a forerunner or an accompaniment of cancer. When the latter disease has established itself, it renders the prognosis more grave, though very early cancer may be healed for a time at least.

Prolonged treatment is necessary, and the radium application has to be well screened to avoid damage to the healthy tissues. When large areas require to be treated it is advantageous to combine X-rays with the radium, thus enabling the area to be more rapidly treated. Special portions may be subjected to a longer radium exposure.

**Pruritis.**—In the treatment of this disease advantage is taken of the well-known analgesic powers of radium. The condition is accompanied by a degree of chronic infiltration of the skin, and the object of treatment is, therefore, to restore the skin to a normal condition before a permanent benefit is obtained. In chronic cases this is extremely difficult. A marked degree

of reaction is necessary, and this may lead to an aggravation of the symptoms for a time. Patients are consequently discouraged, and it is difficult to induce them to continue a treatment which appears to be doing more harm than good. If treatment is persevered with, marked benefit will follow in a large percentage of cases. Filtered rays and long exposures are necessary; 1 mm. of silver or lead should be employed, and several layers of lint interposed between the tube and the skin. In other cases it may be necessary to use filters of platinum up to 2 mm. Twelve to fifteen hours' exposure of 50 mgrms. of  $\text{RaBr}_2$  may be given, and this dose repeated in three to four weeks, care being taken not to overdo the exposures.

## RADIUM IN GYNÆCOLOGICAL PRACTICE

The diseases in which radium will be found most useful are :

- (1) Chronic endocervicitis.
- (2) Chronic endometritis.
- (3) Leucoplakia vulvæ.
- (4) Cancer.
- (5) Fibro-myomata.

A short description of the technique in each of these diseases is necessary, with an approximate estimation of the results and degree of benefit received.

**Chronic Inflammatory Conditions of the Cervix.**—These may be treated by two methods :

1. The introduction of a metal tube containing radium into the cervical canal, with additional tubes arranged in the fornices, around the lips of the cervix, when disease is situated here. The metal tube can be firmly fixed to a sound, to facilitate its introduction.

2. An emanation tube can be made to suit the particular case requiring treatment. It is charged with the emanation, so as to allow of full activity at the time of application. It is possible to have the applicator so made as to contain emanation equal to 100 mgrms. of radium or more in a very small cubic space, or if it is desirable to weaken the action, the applicator may be made larger, and the gas allowed to diffuse itself over the larger space.

The size and shape of the applicator and the quantity of radium or emanation to be used being thus arranged, the next matter is the exposure. This is largely a matter of experience, and each case must be judged on its own merits.

**Chronic Endometritis.**—When there has been considerable hæmorrhage which cannot be controlled by other methods, a radium tube may be introduced into the body of the uterus. The rays will often check the hæmorrhage, and also the seropurulent discharge which accompanies the condition. The exposures should be long, and filtration is necessary if it is desired to influence changes in the deeper layers of the endometrium. The treatment should be continued at intervals of three to four weeks, until the condition has returned to a normal state.

**Leucoplakia Vulvæ.**—This condition, which causes much discomfort both mentally and physically, is frequently greatly relieved, and often occasionally quite cured by thorough radiation treatment. In some cases X-rays are found to be more useful than radium, while in others radium acts like a charm. Sometimes it is well to apply a radium tube to those portions of the affected area where the disease seems most active, and to treat the more

widely but less deeply affected skin areas with X-rays. By combining the agents it is often possible to get much better results than when either is used separately. The exposures should be frequent, once or twice a week for several weeks. When frequent doses are given, filtration is necessary, and it should be increased in proportion to the frequency of the dosage. The radium should be applied in large quantities, filters of 1 to 2 mm. of platinum enabling exposures of up to twenty-four hours to each area to be given. In the early stages of treatment, however, it is better to give divided doses with light filtration, and wait for a reaction on the skin. If this relieves the irritation (it occasionally increases it) it is best to wait till this reaction subsides, and then give another dose, filtered this time, and then repeat, increasing the filtration and duration of the exposure. When all irritation has subsided, it is advisable to continue treatment for several months, in order to carry on the beneficial action of the rays.

**Cancer of the Cervix Uteri.**—Radium treatment may also benefit this condition. Hæmorrhage and discharge are lessened, and great relief from pain is a frequent result of treatment. Active treatment by radium in cancer of the cervix has yielded encouraging results. When possible, several tubes should be used. One is introduced into the cervical canal, and the others placed around the cervix, these being packed in position with tampons. When a preliminary partial excision has been performed, the radium tubes are introduced while the patient is under the anæsthetic. In all cases requiring treatment the use of an anæsthetic allows of the placing of the radium in correct position, and greatly favours the prospect of improvement. Several cases of early carcinoma so treated have done remarkably well. Con-

tinental writers who have been using radium and mesothorium, claim that the operative treatment of cancer of the cervix is no longer necessary. No doubt time and a larger experience will lead them to considerably modify this opinion, but the results obtained by radium treatment may compare very favourably with those obtained by operation. The tendency to recurrence exists when either mode of treatment is followed.



FIG. 240. — Uterine sound with radium tube at extremity. A suitable applicator for introduction into cavity of uterus. (Suggested by Mr. Lionel Provis.)



Time alone will show in which group of cases the larger percentage of cures occurs. Further, radium and mesothorium methods may improve in technique, and so improve the results. Up to now the hard ray only has been most largely employed. The softer Alpha and soft Beta rays have all been excluded by filtration. It is possible that by using emanation in properly shaped and suitably sized glass tubes, which will allow the softer rays to get through, a more favourable action may be induced.

*Exposures of Radium in treatment of Cancer of the Cervix.*—This is always a matter of difficulty, the duration depending upon the object to be attained. In all cases a filter of at least 1 mm. thick is necessary. An exposure of six hours will lead to considerable reaction. This should slowly subside, and cicatricial changes set in. When 2 mm. of platinum are used the exposure will be proportionately longer, twelve to fifteen hours being necessary. In advanced cases, where there is a considerable amount of ulceration, and the radium tube can be placed in position completely surrounded by growth, much longer exposures may be made; twenty-four hours or more will result in the breaking down of the ulcerated surfaces and the replacement of the tumour tissue by fibrous tissue. In early cases it is well to proceed with caution, giving small doses at frequent intervals, and carefully watching for reaction and improvement. When the latter sets in it should be continued by judiciously administered doses until the whole of the growth has disappeared. When such a fortunate result is obtained, it is still necessary to continue treatment with thicker filters, in order to reach the outlying portions of growth. In the experience of several workers an apparent cure of the local condition has been followed in a short period of time by involvement of the deep pelvic glands, and a rapid development of these has led to the death of the patient.

While radium does not appear to exercise any specific influence over these growths, it is probable that if the radiations could be applied in sufficient intensity the growth might be mitigated. It is possible that the doses given for the local condition may have exercised a stimulating effect upon the more distant portions of the growth. In all exposures the ruling factor is the quantity of radium used. The doses suggested above are taken as for 100 mgrms. in  $\frac{1}{2}$  mm. platinum tubes, and at least 1 mm. of silver. When the  $\frac{1}{2}$  mm. tube alone is used, the exposures are proportionately less.

**Treatment of Fibromata.**—The technique described in the treatment of these conditions by X-rays shows the type of case likely to derive benefit from the treatment. The same types can be successfully treated by radium, and the technique will depend upon the quantity of radium used. The exposures may be made in four directions:

- (1) Through the anterior abdominal wall.
- (2) From the perineal aspect.
- (3) Tubes can be introduced into the interior of the uterus and vagina.
- (4) From the back.

The two agents may be combined: X-ray exposure should be made in the usual way, and a radium tube or tubes introduced into the vagina and

left there for the necessary time. Mesothorium can be used instead of radium, or to supplement its action when the quantity of the latter available is not sufficient.

## RADIUM IN SUPERFICIAL EPITHELIOMA AND RODENT ULCER

These are numerous, and occur in many situations in the body. Superficial, mildly-malignant epitheliomata yield readily to radium treatment, a few exposures of several hours' duration to a case of this kind ending in a healing of the surface. Such cases, however, yield quite as readily to X-ray treatment. The vegetating cutaneous epithelioma comes under this heading. Under this head it is well also to include the most common of all superficial lesions—the rodent ulcer.

Early cases are readily influenced by treatment. They quickly heal, but prophylactic doses should be given after the ulcer has healed. If the condition is quite superficial the filtration need not be great. The Beta rays appear to exercise a profound change in these cases. After healing has taken place filtered doses should be used to reach the deeper parts. Even after thorough prophylactic treatment recurrences are apt to follow at longer or shorter intervals, but frequently respond to further treatment. All cases treated should be kept under observation for a considerable time in order that an early stage of the recurrence may be observed and promptly treated.

When the ulcer is large and involves bone and cartilage the prospect of a cure is not so good. Most complete and powerful dosage may fail to check the progress of the disease. These cases may even be stimulated by radium treatment, and increase rapidly in size. In such cases it is better to combine surgical measures, such as scraping or excision, with radium treatment. Several cases so treated have healed and remained well. These occur in many situations, but most commonly on the face, at the angle of the mouth, and on the outer or inner margin of the orbit. Many of these heal readily, and remain healed; others heal, only to break down after a more or less lengthy interval. Recurrences may be treated as they occur.

There are several methods of treatment for this condition :

(1) Short exposure to radium, with practically no screening. A marked reaction may be induced, which may end in ulceration if the exposure has been unduly prolonged. When this subsides, the ulcer heals and a healthy scar results.

(2) Long exposures with thick filters of 2 or more millimetres of lead. The Gamma ray is almost exclusively employed in this manner.

(3) Combined X-ray and radium exposures.

It has been observed that a case which fails to respond to radium may respond to X-rays of a hard type, and *vice versa*. This is contrary to the opinion expressed by several authorities, who maintain that a case which has failed to improve under radium treatment will fail to do so under X-rays.

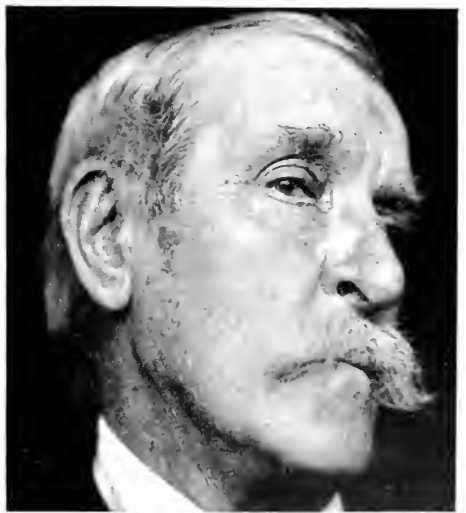
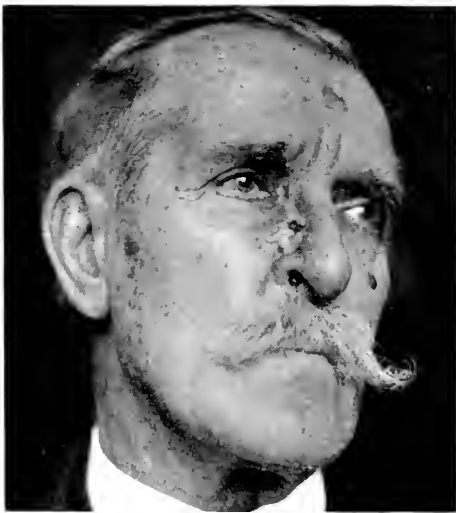

PLATE LXIII.—RODENT ULCERS TREATED WITH RADIUM AND X-RAYS.

*a*, Rodent ulcer of upper lip, showing rapid improvement under combined X-rays and radium treatment.  
*b*, Rodent ulcer of side of nose which rapidly healed after radium had been applied. The ulcer re-appeared after about nine months, but again quickly healed after further treatment.



Some assert that a case which has not benefited from X-rays, and which has had prolonged X-ray treatment, fails to show improvement when treated by radium. Others say that radium invariably heals such cases.

In the experience of the writer, cases respond to X-rays and radium according to the state of activity of the ulcer at the time of treatment. The ulcer which has failed to improve with radium will sometimes clear up in a remarkable manner when subjected to a long exposure of hard, well-filtered X-rays.

The explanation of the conflicting opinions probably lies in the fact that it is a particular type of hardness of radiation which is necessary for the therapeutic effect, and when this type is available, it matters not whether it is produced by X-rays, radium, or any other radioactive body. In many of the cases treated which do not improve, or get rapidly worse, we have not been using the correct ray, or, if we have done so, the exposure has been too short to produce the effect which should result in healing. This is probably the explanation of the conflicting results obtained by many workers.

Ulcers situated near the orbit, nasal cavities, or angle of the mouth require modifications in the treatment. Near the orbit care must be exercised that the eyeball and conjunctiva are not injured. When it has become involved by the growth, it is better to remove it and thoroughly scrape the surrounding tissues. The following types of rodent ulcer have been treated with more or less success :

Superficial epitheliomata of the side of the face, a thin widespread superficial growth without ulceration. This type readily responds. Some of these cases are surrounded by nodules, which generally disappear slowly but surely. The common situation is the malar area. The lateral aspect of the nose is another area which is often affected, the ulcer tending to spread into the orbit. For both these types the flat applicators with very light screen are advocated at the commencement of treatment : later the thicker filters should be employed. Ulcers which tend to extend downwards into the tissues and spread locally are more difficult to deal with. Such ulcers are very apt to recur after treatment is stopped ; deep filtration should be employed in these cases. When cartilage and bone are involved, the cases do not yield so easily. Prophylactic treatment should be carried out for some time after an apparent cure, in the hope that a recurrence may be prevented.

In regard to the practical application of radium to this latter type of case, it may be claimed that when the growth is not very malignant, radium should be given a good trial ; the percentage of cures obtained compares favourably with the percentage obtained in cases which are operated upon. The results are better than those obtained by operation, in that the scar is soft and pliant. The convenience of application and the freedom from pain and discomfort are also factors in favour of radium treatment. When time is of value and æsthetic considerations of no great moment, the operative method gives a speedier result. Surgical measures may be profitably combined with radium treatment. Excision or scraping of the actual growth and after

treatment by radium will often give a better result than when radium alone is used.

## RADIUM IN INFILTRATING EPITHELIOMA

These occur in the preauricular and other regions. They show peripheral inflammatory changes with a thickened edge. They tend to heal spontaneously in parts of the surface. The treatment in these cases must be rigorous. Deep penetrating rays should be tried after superficial healing has taken place, and a number of prophylactic doses should be given. An obstinate variety of this class is found in or round the auricle, and frequently inside the meatus. Radium tubes may be introduced into the auricle and left there, marked inflammatory reaction being necessary before any improvement can be expected.

Epithelioma are also met with inside the nose and on the temple. A form very difficult to deal with successfully is the type met with at the junction of skin and mucous membrane. Because of the mixed character of the cutaneous surfaces the growth presents two aspects for treatment, that involving the skin on one side and the mucous membrane on the other.

The eyelid is occasionally the seat of these growths. Care must be taken to protect the organ of sight. Screens of lead with lint underneath are required, and great care must be taken to ensure correct apposition of the radium to the ulcer. Epithelioma of the nasal mucous membrane is a form commonly met with, and one in which it is extremely difficult to secure healing which will be permanent.

A complete excision of the spreading edge and subsequent thorough prophylactic treatment are measures which commend themselves to the rational-minded radium therapist. A large percentage of these cases go from bad to worse, in spite of the most vigorous radium treatment. They may, however, heal up for a time, but only to break down again. It is only proper, however, to point out that a number of these cases have been operated on, and repeated recurrences developed. Operative measures to be successful must be thorough.

Glandular enlargement when present must be very thoroughly treated. Such enlarged glands yield very slowly to treatment when they are undoubtedly malignant. Some cases of undoubted carcinoma of the tonsil or breast, with many enlarged glands, have been successfully treated. It must be borne in mind that, when glands appear and rapidly enlarge in cases where the primary growth is in a situation where a mixed infection is possible, a part of the enlargement may be due to an inflammatory process super-added to the malignant. Such cases rapidly yield to radium treatment.

After a growth has disappeared under radium, it is important to continue the applications for a considerable time, at regular intervals, in the hope that recurrence may be prevented. The area immediately surrounding the growth should receive thorough irradiation, and also the area of lymphatic drainage.

## RADIUM IN SARCOMATA AND CARCINOMATA

These, on account of their greater extent, deeper infiltration, and more rapid growth are classed among the actively malignant group. The growth may begin in the same situations as the preceding, and are often at the commencement indistinguishable from the less malignant. It is on this account that the need for early operation as an alternative to radium therapy must be well borne in mind. Such cases frequently fail to respond favourably to radium, and a percentage take on a more rapid growth as a consequence of the stimulating effect of the treatment. Treatment must be pushed rapidly to the extreme limit, and if the response is not equally rapid and successful then the question of operative measures must be at once considered.

**Sarcomata.**—The round-celled variety seems to be the type of growth most readily influenced by radium. Large tumours may gradually diminish in size, smaller growths disappear, while secondary glands also clear up. The spindle-celled variety is not so readily dealt with, possibly because it is a more active type of growth. When the mediastinum is involved, exposures may be made over the sternum and ribs in the hope that the disease may be checked. The insertion of tubes containing radium into the tumour mass is the most practical method of treatment. Several tubes may be inserted at points equidistant, in order that the radiations may be equally distributed throughout the growth. The exposure depends upon the quantity of radium used, the size and type of the growth, and the filtration employed. In a large tumour, a tube containing 50 mgrms., with .5 mm. filter may be left *in situ* for twenty-four hours.

When the growth is large, several tubes introduced at equal distances from one another may be left for the same time. In any particular case when, after the first exposure, no marked necrotic changes have resulted, the treatment should be repeated, and, if necessary, the exposure may be considerably prolonged until the desired result is obtained. When the exposure has been accurately estimated, the tumour slowly subsides without any necrosis. This is the ideal method of treatment, but it frequently happens that the correct exposure has not been given, and either no change is induced and the growth increases in size, or it becomes necrotic, and sloughing takes place. This latter change may in time be followed by a healing of the ulcerated surfaces. An attempt should always be made to treat the outlying edges of the growth and the surrounding healthy tissues. Prophylactic treatment should be continued for several months after healing has resulted.

Recurrent sarcoma may be treated by external applications of radium, several cases so treated having cleared up and these still remain well. The quantity of radium used should be as large as possible, 200 or 300 mgrms. in platinum tubes, with 2 to 3 mm. filter of lead and about twelve layers of lint between the radium and the skin surface. The area to be treated may be divided into several portions, and an exposure of twenty-four hours given to each.

**Cancer of the Breast.**—This class of cases forms a large percentage of those sent for radium treatment.

Secondary deposits may be met with in the glands of the axillary and supraclavicular regions. These may be treated at the same time as the primary growth. Secondary deposits in the cartilage of the ribs or sternum may also require treatment. Prolonged exposures to large quantities of well-filtered radium have in several instances led to a diminution in the size of the growth.

The rapidly growing columnar-celled carcinomata may be treated with a measure of success. Tubes containing radium should be buried in the growth, and left for long periods. A diminution of the growth may be looked for, but the prospect of a cure is extremely remote. Less rapidly growing cases are more amenable to treatment. The atrophic scirrhous cancer is the most favourable type for treatment. In some cases a necrotic action can be induced, and the subsequent ulcer gradually heals. Glands should be treated at the same time, and after healing has taken place, prophylactic treatment should be carried out for a considerable time.

**Cancer en Cuirasse.**—This variety often responds well, for a time at least. Enlarged glands, which may be inflammatory in character, are a frequent seat of late involvement. This is probably the result of direct spread by means of the lymphatic stream. An inflamed gland offers a suitable soil for the development of cancerous cells. Radium, by inducing fibrosis, tends to seal up the new growth, and so prevent its spread.

Partial success in dealing with these conditions may lead to a prolonged quiescent stage, which may resume active growth later. The object of the prophylactic treatment is to prevent this late recurrence.

**Recurrent Cancer.**—Secondary growths involving cartilage and bone appear after amputation of the breast. Several cases of this class have been treated with marked success, with radium applied in large quantities for long periods, care being taken to protect the skin. A fairly-marked skin reaction may be obtained after long exposure to filtered radium, this slowly subsiding and resulting in no permanent damage.

Recurrence after operation frequently requires treatment. Small nodules readily respond, and often entirely disappear. Enlarged glands are reduced in size. Radium applicators may be used directly over particular glands or groups of glands with a fair measure of success. In a number of cases, where there is a possibility of doing good, radium tubes may be inserted into the recurrent mass.

Radium, in the treatment of diseases of the breast, should be strictly confined to cases which for some reason are unsuitable for operation. Early cases might be treated, were it possible to place complete reliance upon radium as a curative agent. Cases have been treated, and have done well, but in the present state of our knowledge it is impossible to give radium the first place in the choice of a remedy. In all cases of early cancer the operative method is undoubtedly the best; it is quicker, safer, and offers the best prospect of a cure. It must, however, be stated that X-rays are, in selected





PLATE LXIV.—RECURRENT CARCINOMA AFTER REMOVAL OF BREAST.

*a*, Recurrence in scar after operation for carcinoma of the breast, treated wholly by X-rays.

*b*, Recurrence in scar involving sternum and ribs after operation for removal of carcinoma, treated with radium, prolonged exposures with 200 mgrms. of radium filtered through 3 mm. of lead.



cases, quite as useful as radium. In patients who refuse operation, or are for other reasons not suitable for operation, radium is a useful remedy. In inoperable cases radium may help to render the case operable, and failing that it is undoubtedly useful as a palliative measure.

When a large tumour of the inoperable type has to be treated, it is useful to combine X-rays with radium. The former can be used to irradiate rapidly the tumour area and the lymphatics draining it, and after a time, when the tumour has subsided, radium tubes may be introduced into the substance of the growth and left *in situ* for two days, or longer if necessary. The treatment results in considerable shrinkage in the size of the tumour, and it is quite possible to render an inoperable case operable.

The classification of cases for radium treatment is similar to that given under X-ray therapeutics.

### RADIUM IN CANCER OF THE TONGUE AND MOUTH

This condition is frequently sent for radium treatment. Tubes may be buried in the growth, and benefit is occasionally obtained, though in

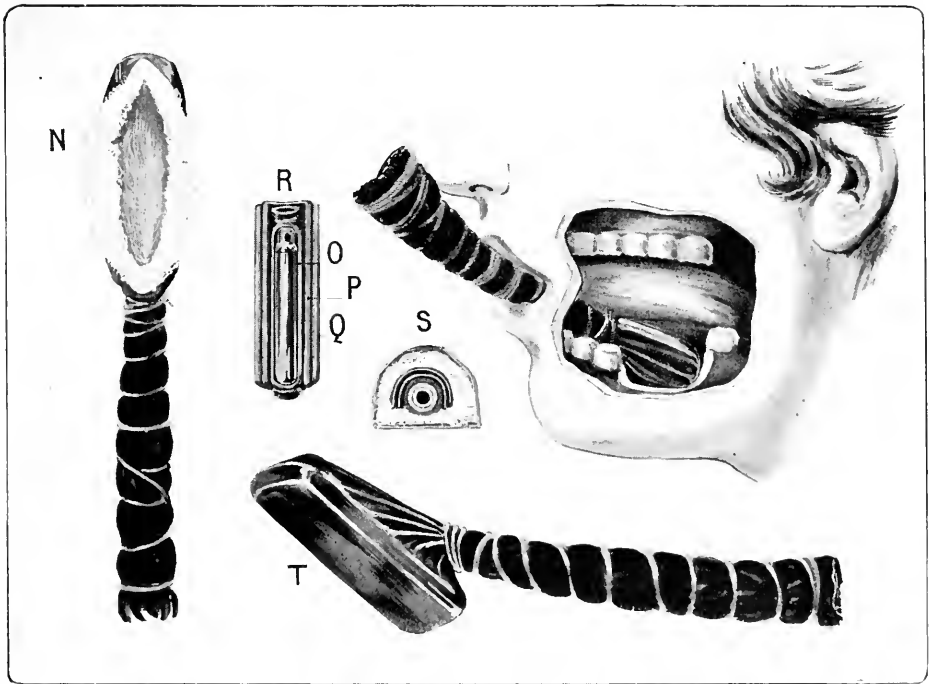

FIG. 241.—Radium tube arranged for the treatment of the floor of the mouth. (Siemens.)  
*N* shows applicator in protective material with handle. *O*, radium tube. *P*, rubber filter.  
*Q*, protective material. *S*, cross section. *T*, flat applicator arranged in a similar manner.

this class of case, as in many others, operative measures should come first. Temporary benefit may follow, but sooner or later recurrence shows itself,

and this may take on a very active form. Cancer of the floor of the mouth is a condition which does not respond favourably in a large number of cases treated. When possible, tubes should be buried in the growth. When this is not done, a useful form of applicator may be used (see Fig. 241). A window can be cut in the lead tube surrounding the radium tube, the rays passing through the window directly on to the growth, while the surrounding tissues are protected to some extent by the thick lead.

## RADIUM IN CANCER OF THE ŒSOPHAGUS

This condition has been treated with a beneficial result for a time. A number of patients have gained weight, and retained the use of the œsophagus

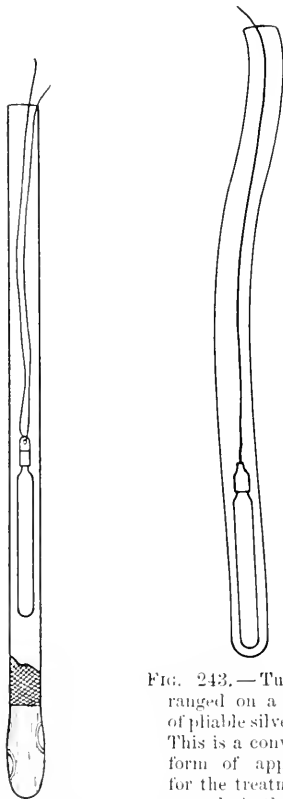

FIG. 242. — Radium tube in an œsophageal tube, arranged for the treatment of an œsophageal growth.

FIG. 243. — Tube arranged on a length of pliable silver wire. This is a convenient form of applicator for the treatment of growths in the lower half of the œsophagus. The wire keeps the radium tube in position, and it is fixed outside the mouth with adhesive plaster.

up to the time they died of secondary growth in the mediastinum. It is important that the stricture should be definitely located before the radium tube is introduced. A radiographic examination with a bismuth cachet or semi-liquid bismuth is used to enable us to recognise the stricture. A radium tube in a platinum filter, 2 mm., is attached to a length of pliable silver wire, which is enclosed in a rubber tube of 2 mm. thick to cut off the secondary radiations. When it is desirable to produce a superficial reaction a thinner filter may be used, a  $\frac{1}{3}$ -mm. platinum tube in a rubber tube being used. The exposure is proportionately shorter, a larger percentage of the Beta rays being employed. The tube is passed into position either with or without an anæsthetic (in most cases it is better to give an anæsthetic), and then with a Brunning apparatus the stricture can be examined, and if necessary dilated to allow of the passage of the radium tube. The silver wire is brought out at the mouth and fixed to the side of the face. When the exposure is finished a special tube may be introduced through the stricture, this securing the double

purpose of keeping the channel open for a time, and of allowing the

patient to be fed through the tube. The duration of the exposure is determined by the quantity of radium used and the amount of growth present. A radiograph may be taken later to determine if the radium tube has been accurately placed in the stricture. Reaction follows the exposure, and the stricture may for a time become narrower from this inflammatory reaction.

Sloughing of the surface in contact with the radium tubes may occur, though if the filtration is adequate, and the exposure accurately gauged, this need not occur. A resolution of the growth on the surface of the œsophagus may be induced with little or no sloughing. When marked sloughing has occurred, the healing process which follows may lead to a cicatricial narrowing of the œsophagus, which will in effect be as harmful as the original stricture due to the presence of the



FIG. 244.—Shows radium tube *in situ*, for the treatment of carcinoma of the œsophagus, situated close to the cricoid cartilage.

growth. This cicatricial stricture can, however, be treated by the passage of bougies, and dilated from time to time. The dilatation may be brought about by passing a Brunning tube past the stricture. This can be done in the course of the repeated examinations, which should always follow after healing has been brought about.

## RADIUM IN CANCER OF THE RECTUM, THE PROSTATE GLAND, AND THE BLADDER

### In Cancer of the Rectum

Symptoms may be relieved for a time. The tube containing the radium must be passed into the stricture, otherwise it may act as an irritant to the healthy mucous membrane and increase the distressing symptoms so common in this situation. Emphasis must be laid on the point that it is absolutely essential that the tubes be placed in the midst of the growth. This can only be done when the lumen of the bowel is still patent and the growth involves the whole bowel. The growth

shrinks, and the function of the bowel may be restored for a time if a sufficient quantity of radium is used and a long enough exposure is given.

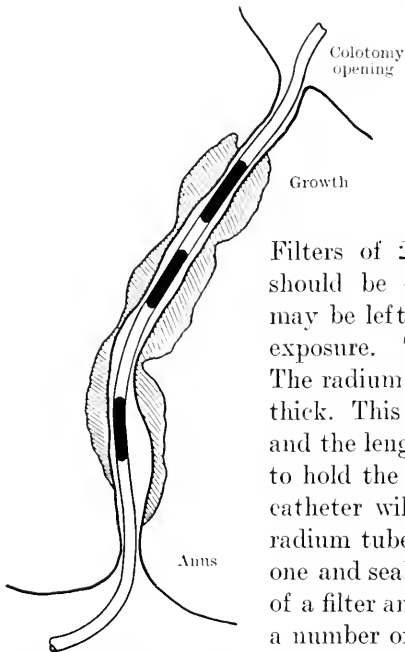

FIG. 245.—Diagram to illustrate method of introducing radium tubes into lower bowel.

The dark lines represent the radium tubes, the shaded areas the growth. The radium tubes are enclosed in a long rubber tube.

and downwards, so as to ensure an equal distribution of the radiation over the entire surface of the growth.

The results obtained in the treatment of this disease are disappointing, largely due to the fact that the majority of cases treated are advanced ones, and not likely to improve, whilst the favourable cases which offer the better chance of a successful result are rightly submitted to early operative measures.

Filters of 2 mm. of platinum, and rubber tubing, should be employed; 100 mgrms. in these filters may be left *in situ* for about fifteen hours for an exposure. This may be repeated in a month's time. The radium tube is enclosed in rubber tubing 2 mm. thick. This is introduced into the lumen of the bowel, and the length of rubber is strapped outside, serving to hold the radium tube in position. A soft rubber catheter will be found an excellent holder for the radium tube. A thin rubber tube placed over this one and sealed at one end serves the double purpose of a filter and of keeping the radium tube clean. In a number of cases it will be possible to pass a long flexible tube from the rectum through the lower opening of a colostomy wound, when several tubes may be introduced, and applied to the whole of the canal affected by the growth. In this way a thorough exposure may be obtained at one treatment. During the exposure the tube containing the radium tube can be moved several times upwards

## In Cancer of the Prostate Gland

This may be treated by four methods :

- (1) By the rectum.
- (2) By tubes introduced into the bladder. The tube is enclosed in a catheter.
- (3) By a number of tubes introduced into the substance of the gland. The perineal route may be employed.
- (4) Post-operative treatment. Tubes can readily be introduced into the bladder after operation.

When treating by method No. 1 radium should be filtered through 2 mm. of platinum. Comparatively long exposures may be given, up to twelve to fifteen hours, using 100 mgrms. of radium.

No. 2.—This does not allow of very thick filters, therefore the exposures must be reduced proportionately.

By method No. 3, provided the tubes can be quite surrounded by the growth, comparatively long exposures may be given.

After complete removal of the prostate gland radium tubes should be left in the tissues at the base of the bladder for several hours, with thick filters, the object of treatment in this case being prophylactic.

### **In Cancer of the Bladder**

If a tube can be introduced into the bladder and brought into contact with the growth, relief may be obtained, and hæmorrhage and discharge are lessened. In some instances a marked improvement in the condition of the patient ensues, and the tumour may diminish greatly in size. Simple conditions of the bladder may also benefit from radium treatment, papilloma will be checked in growth, and hæmorrhage is stopped for a time at least. In bad cases it is good practice to combine X-rays with radium. The former may be employed through the abdominal walls and the perineum.

## C. THE COMBINED USE OF RADIUM AND X-RAYS IN THE TREATMENT OF MALIGNANT DISEASE

In the preceding pages on radiation therapeutics the strictly practical aspects of the methods have been rigidly adhered to. Reference to cases where success has attended the treatment are given as occasion indicates, but an expression of opinion as to the value of radium or X-rays as a curative or specific agent has been omitted, the aim of the book being to give a practical insight into the methods of usage rather than a speculative one of value in relation to curative effect.

A brief review of the general experience of workers in the new field of therapy would seem to be a fitting conclusion to the book, with particular reference to that aspect of the remedies on which an opinion is so often demanded.

The results obtained in the earlier days of trial of these agents led to the expectation of enhanced results as experience grew, and methods of technique were improved. These expectations have been realised to some extent, and there is reason to hope that, with accumulating experience and a more complete knowledge of the action of radiations upon cell processes, further improvements may be looked for.

There has been a marked advance in the technique of X-ray therapy, which bids fair soon to place X-rays upon the same footing as radium in the treatment of malignant diseases. Indeed, in the opinion of many workers, including the writer, it is probable that X-rays may soon prove to be more useful than radium as it is at present used. The factors which have led to this improvement are : (1) A great advance in the manufacture of the X-ray tube, enabling much larger doses of a more penetrating ray to be employed ; (2) the employment of much more powerful apparatus which the use of the new tube facilitates ; (3) the use of thick filters ; (4) the administration of more powerful doses at more frequent intervals.

A further factor which has led to improvement has been the employment of both agents together or alternately, radium being used for the more strictly local applications, and X-rays for the treatment of the more distant parts which may already be involved by new growth, or may be likely to become invaded as a result of the extension of the disease by natural channels, or as a direct result of the local stimulation if dosage is not correctly gauged.

In the treatment of non-malignant neoplasms such as fibromata, the treatment by X-rays alone has been attended with a considerable degree



of success. The early work of Continental investigators has stimulated work in the same direction in this country, and results are now being obtained in both simple and malignant neoplasms which are of very striking significance in view of what can be done by the older and better recognised methods of treatment. In many instances of fibromata marked improvement follows the initial series, and after four or five courses of treatment the condition is relieved and the patient restored to good health. Results obtained in these cases by radiation treatment compare very favourably with the results attending operative measures, even when the most favourable cases for operative treatment are included in the cases analysed.

For malignant disease of the pelvic organs, when at all advanced, radiation therapy holds out as good a prospect as operative measures, especially when the latter have to be, as necessarily they must be, extremely radical if a prospect of cure or temporary amelioration is to be held out. It must not be assumed, however, that radiation treatment holds out a better prospect of cure. Recurrences can and do occur, with about the same frequency as after operation, and the result will be in both groups of cases the same in the end ; but when comparing the results consideration must be given to the condition of affairs existing in the interval between the treatment and the recurrence. The treatment by radiations is painless, does not subject the patient to any marked degree of shock, and the immediate effect is apparent in an improvement in health, a diminution or cessation of discharge, and a degree of local comfort.

It is not intended to convey the impression that treatment by X-rays or radium should displace the operative in all cases ; far from it. The ideal method is to employ the former in all cases before operation, and again after operation, the latter in every case. Operations when performed should be as radical as possible, care being taken to exclude from operation advanced cases where the surgeon knows that no good can accrue. In these cases X-rays should be employed as a palliative measure.

All cases of cancer of the breast should receive prophylactic treatment immediately after operation, and this should be continued at intervals for at least a year.

A matter of some importance from a therapist's point of view in these cases is that no case, however advanced, should be refused the trial of X-rays or radium. Some of the most unfavourable cases respond to treatment in a marked manner, while others, which appeared most favourable subjects, respond hardly at all. One case may be quoted. A large superficial ulcerated carcinoma of the breast of over a year's duration completely healed up after about six thorough radiations. The growth still exists, but it is shrinking rapidly, and in the interval the patient enjoys good health and a fair prospect of cure. This case appeared to be most unsuitable because of the large area involved.

The reason why one case responds and another fails to do so is one of the profound problems which the radio-therapist is striving to fathom, and when the solution is arrived at it will go a long way to establish

radiation treatment on a sound, intelligible basis. In all probability the explanation is a biological one, a condition of cell, physical or other, which responds to a particular type of ray, producing far-reaching metabolic changes in cells and sera which act on tissues near and distant proportionately. The biological factor is one which, in the absence of convincing experimental evidence, had better be for the present left alone, as only speculative conjecture fittingly describes any attempt to explain it. Future attempts to clear up this point will no doubt be confined to physical experiments in the direction of producing effects on the deep tissues, and to the interpretation of biological effects by experiments in immunity conferred on tissues by the use of irradiated tumours and sera transplanted or injected. These experiments are being actively carried out by many workers.

The important point from the practical radio-therapeutic point of view is to determine the depth at which a tissue can be influenced, and the dose it is possible to convey at a particular depth of tissue. When these points are ascertained it should be possible to produce changes in deep tissues. Much experimental work has already been done, and an attempt is now made to summarise some of these experiments.

Professors Bumm and Wernekros of Berlin have published a number of experiments which in the aggregate confirm the observations of the writer, who has been experimenting on similar lines for several years. Up to quite recently it has been held that X-rays penetrated successfully to a depth of about 1 centimetre or less, and anything deeper than that has been left alone. The use of radioactive bodies led to the belief that when employing the Gamma ray a much greater depth could be reached, and effects produced by its use which were unattainable by X-rays. Increasing experience leads in the opposite direction, for, by using hard tubes and long exposures of X-rays, effects can be produced as deep as 10 cm., and those of quite a marked degree. The same results may be obtained from the use of radioactive bodies if the quantities are large and the time of exposure is prolonged enormously, too long for safety so far as the tissues in immediate contact with the source of irradiation are concerned.

The X-ray tube produces many thousand times more rays than any available quantity of radium, while it is possible to work at a greater distance from the skin or mucous surfaces (a measure of safety being thus introduced), and at the same time produce an effect on the deeper tissues which is beyond all possible comparison with that of the radioactive bodies even when the Gamma ray of radium alone is used.

Wernekos and others have conducted experiments which appear to prove this contention beyond any doubt. With a Kienböck strip placed in tissues or organs at a depth of several centimetres and the surface of the body radiated with an X-ray bulb, in ten minutes' exposure 10 X have been recorded on the paper. With a long radiation of 200 mgrms. of mesothorium applied to the skin no effect is recorded on the paper, while in time the skin surface showed marked reaction. These points have been experimentally

proved by using an electroscope and the iontoquantimeter of Szillard, and have been confirmed on the living tissues.

It has been suggested that radium and mesothorium possess a qualitative difference over the hard Röntgen rays, and that the Gamma ray has not only a greater penetration but also a more intense biological action, also that the Gamma ray possesses a selective action upon cancer cells; but this has never been proved conclusively, and in another part of the book the writer calls attention to the point that in many cases it may be a less penetrating ray which is required to produce a biological effect on a particular type of cell. In fact, the whole range of rays may be useful from the soft Röntgen ray to the Gamma ray of radium, and each of these rays may be required when a number of cases are treated. "A" may suit one case while "Z" may be necessary for another, and so on.

The penetrating power of the ray is only one factor. The quantity of rays administered is probably more important. It would appear that, in all cases of cancer which are likely to benefit from X-rays, it is more a question of the quantity of rays which can be administered, while with the present apparatus at our command the quality of the ray may be kept at a fairly constant value.

It is now possible to state in a number of cases, according to depth of tissue, what quantity of radiation may be required to produce a favourable result; thus, at a depth of 2 cm. of growth 300 to 500 X may be necessary to cause a retrogressive change in the cancer cells. The maximum depth in any part of the body may be taken as 10 cm. or at the most 15 cm., for if a tumour exists in a deep part of the body it can be and is radiated from two or more aspects. In order to induce a therapeutic effect at, say 10 cm., the intensity diminishing inversely as the square of the distance, the deeper parts receive about  $\frac{1}{4}$  of the total exposure, so that to obtain a dose of, say 500 X at 10 cm., 3500 X is required on the skin surface. It is necessary therefore to exercise great care in the administration of these large doses. Specially hard rays must be employed at a sufficiently great distance from the skin to avoid doing harm to that structure. To produce such effects some risk must be taken, and in the experience of many workers on these lines, radiodermatitis has been produced and must be acknowledged. At the present time, so far as we know, these risks have been minimised, and the difficulties which lead to their occurrence have been overcome.

The points therefore to observe in order to get in these heavy doses of penetrating rays are: (1) employment of thick filters, (2) the distance from the skin and the use of accessory filters of various substances, (3) many ports of entry, (4) sufficiently long intervals between the exposures.

So far we have been able to demonstrate that radiations exercise an influence on tissue change, and that it is often a matter of selection of ray; so we may assume that in the treatment of deep-seated growths X-rays and radium should be combined because of the wider area which can be treated, and the ease with which radium can be applied to regions where X-rays are not easily applied; thus, a rectal cancer can be treated locally by radium,

while from the skin surface it may be attacked by X-rays from the anterior abdominal, the posterior, and the perineal route. Using a good quantity of radium and a penetrating X-ray, the resulting influence over the growth and glands must be enormously enhanced. The X-ray exposures may be carried on in the intervals between the radium exposures.

Similarly in carcinoma of the uterus, whether of the cervix or fundus, the cancer may be vigorously treated after the technique of Freiburg by X-rays and radium introduced into the uterus. In these tumours frequent séances of heavy doses lead to marked effects. Many cases might be quoted where improvement to a marked degree has resulted. Tissue changes can be studied in sections removed during the course of treatment, and all show the typical degenerative processes seen in such cases, which are described and illustrated in pages 256-261.

*Carcinoma of the Mammæ.*—The result of very heavy dosage in nearly all forms of this disease is beneficial. Growths diminish in size, ulcerated surfaces heal, and the general health improves. It is necessary to push the treatment. The skin is divided into squares, and doses given at regular intervals. Each square may receive 300 to 800 X or more altogether during the treatment, which is spread over several months.

There may be some skin reaction, but when dealing with bad cases this must not be regarded as a deterrent. Bumm quotes several cases which derived great benefit. From an extensive experience in the treatment of this form of cancer the writer feels convinced that in the later cases treated, where very heavy doses have been administered, the results show a marked improvement on the earlier cases, where the treatment was not so thorough. Large primary growths slowly diminish in size, recurrences clear up, and the patient receives great benefit. In these cases the X-ray treatment is to be preferred to radium for reasons already stated. It is, however, important that a thorough technique be undertaken.

In the treatment of cancer of the breast in comparatively young subjects from thirty to thirty-five years of age, it is often noticed that, however early and radical the operation may have been, recurrence takes place early, and very little success attends whatever form of treatment is employed. X-rays and radium are no exceptions to this rule.

The explanation of this marked degree of virulence is obscure, and it is difficult to suggest measures which may control the progress of the disease. Such radical operations as double oophorectomy have been employed, but without any great measure of success. Nevertheless the activity of the ovaries may affect the morbid process, as presumably at this early age all the tissues are in a state of full activity, and no doubt the new growth participates to a varying degree in this, and quickly spreads to the adjacent lymph and other structures. It is also well recognised that the most favourable cases for any form of treatment occur in patients at or after the menopause, when atrophic cancer is often met with.

Instead of oophorectomy a method of treatment by radiations is here suggested. In addition to the local post operative treatment the ovarian

areas should be thoroughly treated by several series of exposures until a temporary menopause is produced, following the Freiburg technique.

*Mediastinal Cancer.*—In this condition, which is frequently met with, a large field exists for the use of X-rays. This also applies to cases of sarcoma, lympho-sarcoma, and recurrent cancer of the lungs and pleura. The chest is mapped out in squares, anteriorly, posteriorly, and laterally, and each area is treated to the maximum extent at regular intervals. In this way it is possible to get in doses of several thousand X in a comparatively short time. There is every hope that with such thorough treatment a marked advance in the treatment of cancer will ensue. Certainly all patients should be given the opportunity of benefiting by this advanced method.

The administration of these intensive doses involves a great deal of time. Many cases will take six to eight hours for each series of exposures, and this entails a heavy wear and tear on apparatus. Such efficient treatment can only be carried out successfully in hospitals and nursing-homes where the patients can be kept for hours under close observation.

From the study of a number of sections removed at different stages in the treatment of cases of cancer, it may be recorded that marked changes are induced in the tumour cells. These include: (1) enlargement of the nucleus, with increased subdivision; (2) increase of fibrous tissue; (3) gradual disappearance of the cancer cells in the fibrous tissue matrix. Constitutional symptoms are also induced by this heavy radiation treatment. These are similar to those produced by radium treatment, and include a period of marked depression, lassitude, etc. Sickness may come on a few days after the treatment. The patient should be kept quietly in bed for a few days on a generous diet.

The accumulation of experience in the treatment of malignant disease serves to demonstrate that in these comparatively new agents we possess a therapeutic factor which has great influence on cell growth, morbid or normal. The exact degree of influence is difficult to estimate because of the remarkable inequality of the action upon various tissues, and particularly upon the products of tumour invasion. The administration of a large dose of radiations upon the products of inflammation often leads to a diminution of the process and in time to a return of the tissues to normal. The same intensity and quantity of radiation applied to a tissue growth of mildly malignant character may lead to a diminution of the growth and of the malignant process, and a return to the normal or to the formation of a mass of fibrous tissue which no longer exhibits the characteristics of a new growth. Histological investigation of such a mass will, however, frequently show cancer cell remnants in parts of the fibrous tissue. These remnants are still capable of recrudescence, and are liable to resume activity at a later date. The existence of these remnants is therefore a source of danger to the patient, and with such patients, when all has been accomplished that radiations can achieve, the question of operation must be kept well to the fore. The danger of lighting up a cancerous process by operation in these cases is lessened when the patient has been thoroughly treated by rays,

because of the obvious fact that a marked degree of fibrous tissue formed in and around the new growth diminishes the danger of a rapid spread if an operation is performed. This is also a strong argument in favour of treatment before operation, because, if it is thorough, the probability is that the formation of fibrous tissue wide of the growth will tend to prevent the spread of the infected cells at the time of the operation. Should such cells exist at the time of treatment it is probable that they are damaged by the radiations, and are no longer violently infective. Similarly, after operation, should any infected tissue remain, the reactive processes set up in the tissues may lead to the inclusion of these in fibrous tissue, and the subsequent degeneration of the cells lead to a lessening of their activity.

The subsequent course of patients so treated is being watched with great interest. Is it possible to prevent recurrence and confer upon the patient a period of comparative immunity? The early recurrence of a neoplasm after radiation treatment does not necessarily prove that the treatment taken as a whole is of no value. It merely demonstrates that we have not given a dose sufficient to check the particular malignant process in activity in the case. It must also be borne in mind that there are growths which cannot be influenced by any radiations at present at our command. It would appear that these cases are quite as irresponsive to any other form of treatment. Complete radical excision of a comparatively early growth, with apparently no involvement of glands, is followed by a complete recovery. Later, but in these cases comparatively soon after operation, recurrence shows itself in the scar or neighbouring lymphatic glands. No subsequent treatment appears to do any good. Radiation treatment in a case of this type would, however early and thorough the treatment might be, achieve no better result.

It is the less virulent case which is more amenable to both methods of treatment. The choice of treatment in these cases raises a wide and difficult question. Which of the two methods promises the better result? In the present state of our knowledge of radiation therapeutics, in the great uncertainty of action upon particular types of tumours, the preference must be given to early operation, which should be as thorough as possible and should be followed by X-ray treatment.

The following conclusions on the value of X-rays and radium in the treatment of malignant disease can be drawn:

(1) These agents are most valuable aids to the treatment of these conditions in so far as by their use we can induce changes in tumours which are unattainable by any other agent at present in use.

(2) X-rays and radium may be used separately or combined in the same case, and in some instances it is advantageous to alternate the use of the two.

(3) In so far as it is possible to demonstrate profound changes in inoperable growths of large size, it is a logical conclusion to arrive at that cancer tissue of small size left at the time of operation may by post-operative treatment be rendered inert, and recrudescence of growth be prevented.

It is therefore sound policy to insist on post-operative treatment in all cases submitted to operation. The post-operative treatment must be carried out with as complete thoroughness as when we are attempting to induce the resolution of a growth of considerable size.

When a thorough course of treatment has been applied the patient should be instructed to come at intervals for inspection, and if necessary for more treatment for two or three years after the operation.

(4) Other methods of treatment must not be neglected when the radiations are being used. Thus, it may be advisable to remove growths which appear to be arrested or which are not yielding to treatment. This will greatly aid in the administration of radiations and lead to an improvement in results. Drugs which are known to aid the action of radiations should be used. Thyroid extract is known to exercise a far-reaching effect upon tissue metabolism. Pfahler of Philadelphia recommends the administration of thyroid extract in nearly all cases submitted to radiations. Iron, arsenic, and in some cases salvarsan may be used as aids to treatment by radiations. In several cases which have had the latter drug administered, rapid changes have been induced in the blood and tissues by radiations administered subsequent to the drug.

In conclusion, it may be stated that in all probability the treatment of malignant disease by radiations is not nearly so efficient as it may be in the future. With advancing knowledge, improvements in apparatus and technique, and a more perfect understanding of the tissue reaction to radiations, there is every hope that in the near future a great advance in results will be attained.





## GLOSSARY

**Accumulator.** A secondary or storage battery.

**Actinic Ray.** A ray of light or other form of radiant energy capable of producing chemical action.

**“Alive.”** A wire is said to be alive when an electric current is passing along it.

**Alternating Current.** Currents whose directions are periodically reversed.

**Ammeter** or **Amperemeter.** Any form of galvanometer which is capable of measuring current strength in amperes.

**Ampere.** Unit of strength of the electric current, exerted by an electromotive force of one volt through a resistance of one ohm.

**Anode.** The positive pole of an electric battery or the electrode connected with it.

**Anticathode of X-Ray Tube.** A plate of platinum or other metal, supported inside an X-ray tube upon which the cathodic stream impinges.

**Aperiodic Galvanometer.** A galvanometer whose needle comes to rest without oscillations.

**Armature.** A coil of wire made to cut the lines of force from the field magnets.

**Automatic Cut-Out or Switch.** A device for automatically cutting off the current at any predetermined period of time by means of a time relay.

**Battery.** Apparatus for the production of an electromotive force.

**Blowing a Fuse.** The melting of a wire by the passage of an electric current through it.

**Break** (noun). (*a*) An instrument for periodically interrupting a circuit; (*b*) any interruption in an electric wire.

**Break** (to—verb). To interrupt an electric circuit as opposed to closing the circuit.

**B.T.U.** Board of Trade unit = 1000 watt-hours.

**Buckling.** The disintegration of the surface of the plates of a storage battery.

**Calibrate.** To determine the absolute values of scale divisions of an electrical instrument such as a galvanometer, voltmeter, wattmeter, etc.

**Candle Power.** The intensity of light emitted by a luminous body estimated in standard candles.

**Capacity of Condenser.** The quantity of electricity a condenser is capable of holding in coulombs when charged to a pressure of one volt.

**Cathode.** The negative pole of an electric battery, or the electrode connected with it.

**Cathode Rays.** Rays originating in a vacuum tube at the negative terminal, when a discharge of electricity is passed through the tube. They are not identical with the Röntgen rays, since they are deviable by a magnet and by refracting media, and are rapidly absorbed by opaque bodies and by the atmosphere.

**Circuit.** A term employed to denote the total electrical path of an installation.

**Commutator, Current Reverser.** An apparatus for reversing the direction of the current.

**Condenser.** An apparatus for storing a large amount of electricity.

**Conductor.** Any substance which conducts or possesses the power of conducting electricity.

**Continuous Current** (also called Direct). A current whose direction is constant, as distinguished from alternating current.

**Coulomb.** Is that amount of electricity which is carried by an ampere flowing for one second past any given point in the circuit. There are 3600 coulombs in one ampere-hour.

**Current Strength.** In a direct-current circuit the quotient of the total electromotive force divided by the total resistance, or  $C = \frac{E}{R}$ .

**Current Transformer.** (a) An instrument for changing an alternating into a direct current, or *vice versa*; (b) a device for altering the pressure of a current, which may be either a step-up, *i.e.* raises the pressure, or a step-down transformer, *i.e.* lowers the pressure.

**Dead-Beat Galvanometer.** A galvanometer whose needle comes quickly to rest instead of repeatedly swinging to and fro, through being heavily damped.

**Dielectric.** Any material which offers high resistance to the passage of an electric current.

**Difference of Potential.** When electricity moves, or tends to move, from one point to another, there is said to be a difference of potential between them.

**Discharge.** The disruptive passage of electric current when opposite polarities approximate, or a sudden equalisation of potentials.

**Dynamo.** A machine for the conversion of mechanical energy into electrical currents by means of electro-magnetic induction.

**Dyne.** The unit of force, *i.e.* the force which, if it acted for 1 second on a mass of 1 gramme, would, if the mass were previously at rest, give it a velocity of 1 centimetre per second.

**Electric Efficiency.** The ratio between the amount of current generated and the expenditure required to produce it.

**Electroscope.** An apparatus for detecting the presence of an electric charge or determining its polarity.

**E.M.F.** Electromotive force. The force exerted by an electrical charge.

**Erg** (*ergon*, work). The unit of work. It is that which is effected in raising 1.981 gm. to the height of 1 centimetre.

**Farad.** The practical unit of electric capacity.

**Fault.** Any defect in the proper working of a circuit.

**Field (Magnetic).** The space about a magnet through which its influence is active.

**Filtration of X-Rays.** Placing in the path of the rays some medium such as aluminium or felt, in order to absorb some of the softer radiation.

**Fluorescent (fluoroscopic) Screen.** A screen covered with fluorescent material, which permits the visual examination of the human body by means of X-rays.

**Fuse (Safety).** A soft metal wire interposed in a circuit, which will melt if a current too strong for safety passes through it.

**Gap-Spark.** The space between the terminals of two conductors.

**Hard.** Hard and soft are terms applied to X-ray and other vacuum tubes; they refer to the relative completeness of the exhaustion therein of the retained air or residual gas. A hard tube has a higher resistance than a low or soft tube.

**Henry.** An electrical unit of inductance equal to the inductance of a circuit when the electromotive force induced in it equals 1 volt when the exciting circuit varies at the rate of 1 ampere per second.

**Hot-Wire Meter.** A meter whose readings are based on the expansion of a wire, due to an increase of temperature, by the passage through it of the current that is to be measured.

**Hysteresis.** A term applied to residual effects in the rapid magnetisation and demagnetisation of a soft iron core lying within a coil of insulated wire, through which an interrupted constant current is flowing.

**Induced Current.** That secondary current produced by induction. It flows in the opposite direction to the primary or inducing current when the latter is made, but in the same direction when it is broken.

**Induction Coil.** An apparatus consisting of two associated coils of insulated wire employed for the production of currents by mutual induction.

**Insulator.** A non-conductor or a bad conductor, *e.g.* glass, rubber, shellac.

**Intensifying Screen.** A surface coated with some fluorescing material, such as tungstate of calcium, placed in contact with the film side of the X-ray plate; the time necessary for exposure is materially shortened.

**Inverse Current.** The current produced in the secondary of an induction coil on the making or completion of the circuit of the primary. Inverse currents flow in the opposite direction to the original current.

**Joule.** The amount of energy employed in maintaining a current of 1 ampere for 1 second against a resistance of 1 ohm—10,000,000 ergs.

**Kilowatt.** 1000 watts.

**Micro-Parad.** Practical unit of capacity.

**Milliampere.**  $\frac{1}{1000}$  of an ampere.

**Milliamperemeter.** An instrument for recording the strength of a current passing in fractions of an ampere.

**Ohm.** Practical unit of electrical resistance. It was decided (Paris Congress, 1884) that the legal ohm is the resistance offered by a column of mercury 106 cm. high, 1 square mm. in cross-section, having about the resistance of 100 metres of telegraph wire.

**Ohm's Law.** The strength of the current varies directly as the E.M.F. and inversely as the resistance of the circuit, or the current expressed in amperes is equal to the E.M.F. expressed in volts divided by the resistance expressed in ohms:

$$C = \frac{E}{R}$$

The law was enunciated by Dr. G. S. Ohm, and is used for showing the relation between Electromotive Force, Resistance, and Current.

**Oscilloscope.** A vacuum tube, constructed so as to show whether a current is unidirectional or oscillatory, and in the latter case roughly in which direction the greater quantity of current is flowing.

**Parallel.** Cells are said to be parallel when the positive elements are all connected to each other, and the negative are similarly connected. The E.M.F. is only equal to the E.M.F. of one cell, but its internal resistance is diminished in proportion to the number of cells thus joined. See *Series*.

**Pole Tester.** Any device for readily determining the polarity of the current, *e.g.* wet blue litmus paper will turn red in contact with the positive pole from a galvanic battery: the red spot will become blue again on the application of the negative pole; or when the end tips are placed in water and a galvanic current is turned on, bubbles of hydrogen will rise from the negative side, while the positive tip will become blackened.

**Potential** = *potentia*, power, ready to act, but not yet acting). It is the condition of electrical tension of a body. This term holds the same relation to electricity that the term level does to gravity; just as water at a higher level tends to move to a point of lower level, so does the accumulation of electric energy, at that point in the circuit at which it is present in excess over any other point in the circuit, tend to seek that point in the circuit at which it is lowest, so that electrical equilibrium may be restored.

#### Radium Definitions:

1 *Curie*, quantity of radium emanation (0.60 cubic millimetres at 0° C. and 760 mm. pressure) in equilibrium, with 1 gramme of radium element.

This quantity gives a saturation current in an ionisation chamber of indefinite dimensions, of 2.67 million electrostatic units (0.89 milliampere). One curie of emanation per litre would equal a concentration of 2670 million Maché units.

1 *Milliurie*, quantity of radium emanation in equilibrium with 1 milligramme (one-thousandth of a gramme) of radium element.

1 *Microcurie*, quantity of radium emanation in equilibrium with 1 microgramme (one-millionth of a gramme) of radium element. One microcurie per litre equals a concentration of about 2700 Maché units.

1 *Milligramme-minute*, quantity of radium emanation produced in 1 minute by 1 milligramme of pure anhydrous radium bromide. This quantity is 0.073 microcurie, and would give per litre a concentration of about 180 Maché units.

1 *Electrostatic unit* (E.S.U.), current measure  $3.33 \times 10^{-10}$  (0.00000000333) ampere.

1 *Maché unit* (M.U.), saturation ionisation current, due to radium emanation from a litre of solution of gas expressed in electrostatic units multiplied by 1000.

**Ray, Röntgen or X.** Rays emitted from the source of radiant energy excited by a discharge of electricity within a vacuum tube, not deviable by a magnet or refracting medium; they pass through opaque bodies, cause certain substances to fluoresce, affect a photographic plate like light rays, and they have peculiar effects upon living tissue, normal and pathological.

**Rectifier.** An apparatus which is used to transform an alternating current into what is practically a unidirectional current. There are several kinds of rectifiers, the simplest of which is the "aluminium cell."

**Resistance.** (a) That which opposes the current flow. (b) The ratio of E.M.F. to the current strength:

$$C = \frac{E}{R}$$

**Rheostat.** An instrument for regulating the resistance of an electric current.

**Rotary Converter.** A machine similar in design to an ordinary continuous current generator, but provided with slip rings, connected to suitable points in the armature winding.

**Sabouraud's Pastilles.** Pastilles of light-green colour, called by Sabouraud tint A, which turned to an orange colour, called by Sabouraud tint B, on being exposed to X-rays, thus measuring the dose.

**Self-Induction.** Induction produced in a circuit by the induction of a current on itself at the make or break of the current therein.

**Series.** Cells are said to be in series when the positive element of one cell is connected with the negative element of the next cell, and so on. The electromotive force of the combination, measured from the positive pole of the first to the negative pole of the last, is thus increased, *e.g.* in a battery with three cells, each having an E.M.F. of 1.5, the total E.M.F. will be volt 4.5.

**Supply, Unit of.** Board of Trade unit.

**Unit Megohm.** 1,000,000 ohms.

**Unit Micro-Farad.**  $\frac{1}{1,000,000}$  farad.

**Unit Micro-Volt.**  $\frac{1}{1,000,000}$  volt.

**Unit Milliampere.**  $\frac{1}{1000}$  ampere.

**Vacuum Tube.** Glass tubes or bulbs from which nearly all traces of gas have been removed.

**Volt.** The practical unit of E.M.F. An E.M.F. which would cause a current of 1 ampere to flow through a resistance of 1 ohm.

**Voltmeter.** An instrument for measuring difference of potential.

**Watt.** Is a volt-ampere, or unit of electrical force.

**Zero Potential.** The earth's potential.

# INDEX

Numerals in italics indicate that there are illustrations on those pages. A full-page plate is indicated by the letter *P.* followed by the number of page at which it appears.

- Abcess of the lung, 203, 204  
Accessories for tube-stands (*see* Tube-stands)  
Accumulator connections, 11  
Acetabulum, injury to, 165  
Achrondroplasia, 172  
Aene vulgaris, treatment by X-rays, 304  
Actinomyces of lung, 202  
Adamson, Dr., treatment of ringworm, 300  
  description of, 301, 302  
Air-cooled tubes, 34, 297  
Alimentary canal, foreign bodies in, 233  
Alimentary system, method of examination, 209  
  radiographic appearances of, 219  
  radioscopy of, precautions necessary, 218  
  X-ray examination of, 209-234  
Alternating current supply, 3  
  high-tension rectifier, 5  
  interrupters for, 26  
  smaller outfits made for, 5  
Anæmia, pernicious, treatment by X-rays, 324  
Anatomical relations of urinary tract, 239  
Aneurism, aortic, 206, 207  
  thoracic, 205  
  (*see also* Chest)  
Ankle-joint, epiphyses of, 144  
  fracture dislocation at, *P.* 168-169  
  fractures at, *P.* 168-169  
  fractures in neighbourhood of, 166  
  in child, *P.* 147  
  radiography of, 136  
  tubercular disease of, *P.* 174, *P.* 181  
Ankylosis, 175  
Anti-cathode, 39  
  distance from plate or object affects intensity of X-rays, 94  
Aorta, examination of, 205  
Apparatus for radiography, arrangement of, 80-90  
  a convenient form of, 81  
  for heavy discharges, 4  
  principle of, 4  
  for single impulse radiographs, 5  
  portable, 81  
Appendix, concretions in the, 241  
Arthritic changes in joints, *P.* 176  
Arthritis following injury to knee-joint, 176  
  hypertrophic, 178  
Articular gout, chronic, 177  
  rheumatism, chronic, 177  
Asthma, 201  
Astragalus (*see* Ankle-joint)  
Atlas, ossification of, 143  
Atrophy of bone, 172, 177  
Axis, ossification of, 143  
Barkla, work on secondary radiations of metals, 254  
Batten, Dr., treatment of skin disease, 299  
Battery for Coolidge tube, 37  
Bauer air-valve, 193  
  regulator, 46, 52  
Bauer qualimeter, 56, 57, 268, 278, 279, 281  
  use in therapeutics, 57  
Beclard, regarding development of bones, 138, 139  
Beclere, emphasis upon continuance of X-ray treatment in blood diseases, 326  
Bequerel ray, 257  
Benign cyst, 187  
Berry, Dr. Martin, chair for radiography of the skull, 123, 125  
Bismuth emulsion, use of, 209  
  meal (*see* Opaque meal)  
Bladder, barium injection of, *P.* 245  
  calculi in, 243, *P.* 244  
  varieties of, 244  
  cancer of, treatment by radium, 377  
  gallstones in, *P.* 241  
  sacculi of, 247  
Blood changes, effect of treatment by X-rays, 253  
Blood, diseases of, treatment by X-rays, 323  
  duration of, 324  
  pernicious anæmia, 324  
  nature of action of X-rays in, 326  
Blood pressure, effect of radium emanations upon, 358  
Blood, red corpuscles in, effect in radiation treatment of malignant disease, 254  
Blood-vessels, effect of radium upon, 257  
Bone, cancer of, 179  
  carcinoma of, 184  
  chronic inflammation of, 170  
  disease, cystic, Elmslie's examples, 173  
  diseases of, 167-173  
  inflammatory affections of, 168-173

- Bone, morbid conditions of, 173  
 sarcoma of, 179  
 simple atrophy of, 172  
 syphilitic diseases of, 171, 180  
 tuberculous disease of, 170  
 tumours of, 179, 180  
   differential diagnosis of, 185-187
- Bones, chronic inflammatory conditions of, *P. 170-171*  
 development of, 138-143  
 normal, radiography of, 123  
 of chest (*see* Chest)  
 of foot (*see* Foot)  
 tumours of, *P. 183, P. 186*
- Bones and joints, injuries of, 154-166  
 (*see also* Diseases of)
- Bordier, Dr., chromo-radiometer, 282, 321  
 formula for filtration, 321  
 technique in treatment of uterine fibromata, 319  
   of uterine fibroids, 321
- Bowel, radium tube introduced into, 376
- Brain, bullet in, 119
- Breast, atrophic scirrhus cancer treated by radiations, *P. 316*  
 cancer of, post-operative prophylactic treatment, 379  
 carcinoma of, treatment by radium, 370, 372  
 carcinoma treated by X-rays, *P. 372*  
 diseases of, radium treatment should be confined to inoperable cases, 372  
   ulcerated carcinoma treated by X-rays, *P. 311*
- Breschet, regarding development of bones, 143
- British Medical Association, discussion at Liverpool meeting of Electro-Therapeutic Section with Anatomical Section, 210
- Bronchiectasis, 203
- Bronchitis, chronic, 201
- Broncho-pneumonia, 194
- Bruce, Dr. Ironside, method of centering the tube, 95
- Brumming apparatus for examination of œsophagus, 374
- Brush high-frequency discharges, 255
- Bullet in brain, 119
- Bunn, Professor, results of experiments with radiations, 380
- Bythell, Dr., report on diseases of lungs, 201
- Cœcum, description of, 231
- Cæcum and ilium, opaque meal in, 230, 231
- Calcareous kidney, *P. 243*
- Calcified mesenteric glands, *P. 243*
- Calculi in the bladder, 243  
 varieties of, 244  
 in the kidney, 241  
 in the ureter, 242, 243  
 urinary, 241-244, *P. 241, P. 244*
- Calculus in ureter, *P. 245*
- Cancer (atrophic scirrhus), treatment by radiations, *P. 316*  
 of the bladder, treatment by radium, 377  
 of bone, 179  
 of the breast should receive prophylactic treatment, 379  
 of the cervix uteri, treatment by radium, 366  
   exposure for, 367  
 en cuirasse, treatment by radium, 372  
 effect of hard Beta and Gamma rays of radium upon, 254  
 increase in size may occur as a result of radium treatment, 259  
 in lungs, 201  
 mediastinal, X-ray treatment of, 382  
 in mouth, treatment by radium, 373  
 in œsophagus, treatment by radium, 374  
 of prostate gland, treatment by radium, 376  
 of the rectum, treatment by radium, 375  
 recurrent, treatment by radium, 372  
 of stomach, 227  
 in tongue, treatment by radium, 373  
 treatment by X-rays, 292
- Cancer Hospital, London, Dr. Jefferson's radiographs of stomach, 217  
 results obtained in examination of the thorax, 194
- Cancer Hospital Research Laboratory, Dr. R. W. A. Salmon's investigations regarding filter equivalents, 293
- Carcinoma of bone, 184  
 of the breast, treatment by radium, 370, 372  
 mammae, *P. 171*  
   X-ray treatment of, 382  
 recurrent after removal of breast, treated by radiations, *P. 372*  
 secondary, 187  
   in chest, *P. 199, P. 201*  
 superficial, treatment of, 255  
 of the tonsil, treatment by radium, 370  
 treatment by radiations, *P. 372*  
 treatment by radium, 371  
 ulcerated, treatment by X-rays, *P. 311*  
 of the uterus, combined use of radium and X-rays, 382
- Carcinomata, favourable influence of X-rays upon, 328  
 treatment by X-rays, 312  
   methods, before operation, 313  
   post-operative, 313  
   results of prophylactic, 314  
 treatment of inoperable, by X-rays, 315  
 of recurrent, by X-rays, 316  
 of ulcerated growths, 315
- Carcinomatous glands, treatment by X-rays, 308
- Caries, 168  
 of spine, *P. 179*  
 sicca, *P. 175*
- Carpal bones, fractures of, 164  
 investigations regarding injuries to, 164  
 table of development of the, 149

- Case, Dr., radiographs of gallstones, 214  
 Cell growth, influence of radiations upon, 383  
 Cervical region, radiography of, 130, 131  
 Cervical vertebrae, showing position for demonstration of cervical ribs, 191  
 Caries of, *P.* 179  
   injuries of, 156, 157  
   ossification of, 143  
 Cervix, chronic inflammatory conditions of, treatment by radium, 365  
 Cervix uteri, cancer of, treatment by radium, 366  
 Chareot's joints, 178  
 Cheloid, treatment by radium, 363  
   treatment by X-rays, 304  
 Chest, bones of, radiography of, 131  
   malignant diseases of, *P.* 188, *P.* 199, *P.* 201, *P.* 204  
   showing aneurism, *P.* 207  
   calcareous glands, *P.* 204  
   chronic pleurisy, *P.* 202  
   dilatation of œsophagus, *P.* 211  
   distended stomach, *P.* 204  
   lobar pneumonia, *P.* 201  
   pleural effusions, *P.* 190  
   pulmonary tuberculosis, *P.* 194, *P.* 197  
   secondary carcinoma, *P.* 199, *P.* 201  
   walls, tumours of, 197, 204  
 Chondromata, 185  
 Cinematographic demonstrations of contractions of stomach, 219  
 Classification of inflammatory affections of bone, 168-173  
 Clavicle, development of, 138  
   fracture of, 158  
   radiography of, 131, 132  
   (see also Shoulder-joint)  
 Climacteric troubles, Albers-Schönberg technique with X-rays, 320  
 Coil, therapeutic, 269  
 Collargol solution, technique of examination with, 247  
 Colles fracture, 162, *P.* 163  
 Colon, bismuth food in, 232  
   description of, 232  
   kinks in, 231  
   opaque enema in, *P.* 234  
   opaque meal in, *P.* 222  
   (see also Stomach)  
 Compression, method of, 69, 132  
 Compressors, 67-69  
   Albers-Schönberg, 67, 68  
   description of, 69  
   kidney, 69  
   Dr. Gilbert Scott's, 69  
   screening stand used as, 72  
 Condenser, construction of, 15  
 Congenital malformations, 248, *P.* 248  
   syphilis, 171  
 Congestion of the lungs, 194  
 Connections of X-ray tube to coil, 40  
 Constipation, chronic, 233  
   intestinal, 233  
 Constitutional disturbance due to radiations, 262  
 Continuous current supply, 3  
 Control apparatus, 15  
   table, 23, 24  
 Converter, motor, 9  
 Coolidge tube, 35-38, 94, 95, 269, 294  
   battery for, 37  
   for heavy currents, 296, 297  
   method of operating, 38  
 Cooper, Astley, and fracture of neck of scapula, 158  
 Coronoid, fracture of, 161  
 Cossar tube, 296  
 Couch, X-ray, for therapeutic treatment, 276  
 Couches, 67-72  
   a convenient form of, 67  
   fitted with protected tube-box underneath, 68  
 Cranial radiography, chair for, 127, 128  
 Craniotabes, 172  
 Curie, Professor and Madame, unit of measurement for radium, 342  
 Current, reverse (inverse), 161, 279  
   method of detecting, 53  
   produces secondary rays, 54  
   suppression of, 48, 52  
   supply, alternating, 3  
   alternating, interrupters for, 26  
   continuous, 3  
   400-volt circuits, 6  
   high-tension is alternating, 9  
 Cyclops tube, 297  
 Cylinder diaphragm, use of, 55  
 Cyst, benign, 187  
   dermoid, in pelvis, *P.* 246  
   hyatid, 184, 187, 204  
   in the heart, 205  
 Cystic conditions of the kidney, 246  
   disease of bone, Elmslie's examples, 173  
 Dactylitis, syphilitic, 180  
   tubercular, 180  
 Dark room, 82, 84  
 Dawson's formula for localisation, 113  
 Deformities, congenital, *P.* 248  
 Degrais on changes which occur in radium therapy, 257, 258  
 Dermatitis, acute, 263  
   chronic, 263  
 Dermoid cyst in pelvis, *P.* 246  
 Dessauer tube, 31, 296  
 Developer, choice of, 97  
   preparation of, 98  
 Development of bones, 138-143  
   of X-ray plates, 238  
 Diagnosis, 97  
   consideration of all the factors essential for, 193  
   value of combined clinical and radiographic, 185  
 Diaphragm, use of, 55  
   cylinder, use of, 55

- Diaphragm, irregularities in the outline of, 204
- Di-electric, 21
- Disease, general, radium applied to, 357  
effect of radium applications in, 358  
practical application of radium to, 345-377
- Diseases of bone, 167-173  
of bones and joints, differential X-ray  
diagnosis in, 179-187  
of joints, 174-178
- Dominici, early work with Gamma ray of radium, 251
- Dorsal vertebræ, 191  
curvature of, *P.* 179  
injuries of, 157  
radiography of, 132
- Dosage, Bordier's chromo-radiometer, 282, 321  
epilation dose, 290  
Hampson's radiometer, 290, 291  
Holzknecht's quantimeter, 282  
incident dose for uterine fibroids, 322  
Ionto quantimeter, 287  
Kienböck quantimeter, 282  
arrangement for exposure, 283  
development of strips, 283, 284  
the standard scale, 285  
tints of developed strips, 286  
Lovibond's tintometer, 288, 290  
methods for estimating, 279-292  
record of exposures, 287  
Sabouraud and Noiré pastilles, 279  
units of measurement, comparison of, 321
- Dosage in radium therapy, 353  
of emanation in solution, 355  
Maché unit, 355  
relation between the value of radium and its activity, 354  
salts, age of, 354  
salts, variation of activity, 355  
standard of activity, 353  
unit of milligram-hours, 356  
unit of radiation, 353  
when the free radium is contained in metal tubes, 356  
when using flat applicators, 355  
when using the Gamma ray alone, 356
- Duodenum (*see* Intestine, small)
- Dust and smoke, effect of inhalation of, 201
- Dynamo for military hospital, 87
- Dynamos, 11
- Dyschezia (*see* Intestine, large)
- Ear, diseases of, treatment by radium, 359
- Eczema, chronic, treatment by radium, 361, 362
- Eczemata, treatment by X-rays, 299
- Edinburgh Royal Infirmary, case of fracture of neck of scapula, 159
- Edouel, explanation of action of X-rays in blood diseases, 326
- Ehrlich, condition termed myelogenous leukemia, 325
- Elbow-joint, dislocation of, 161  
epiphyses of, 150, 151  
fracture dislocation of, *P.* 161  
fracture through head of radius, *P.* 161  
fracture through lower end of humerus, *P.* 161  
fracture through olecranon process, *P.* 138  
injuries in the region of, 161  
injury to epiphysis of olecranon, *P.* 138  
normal, *P.* 138  
radiography of, 134
- Electric energy, sources of, 3  
motive force or spark length, 14
- Electrical supply for military hospital, 87
- Electroscope, 267  
special gold leaf, for radium, 332  
friction device for charging, 342
- Elmslie, examples of cystic disease of bone, 173
- Emery, Dr., report on tumour of tibia, 183
- Empyema, 204
- Endometritis, chronic, treatment by radium, 365
- Endotheliomata, treatment by X-rays, 328
- Epiphyses of hip-, knee-, and ankle-joint, *P.* 147  
of joints, radiographic survey of, 144-153  
of lower end of radius, displaced, *P.* 164  
separation of, 161
- Epiphysitis, syphilitic, 171  
tuberculous, 170
- Epithelioma, distinction from rodent ulcer, 311  
infiltrating, treatment by radium, 370  
superficial, methods of treatment, 368  
treatment by radium, 368, 369  
early cases are readily influenced, 368
- Epitheliomata, treatment by X-rays, 312
- Erythema dose, 57, 58
- Ethmoidal sinuses, radiography of, 128
- Examining chair, universal, 78, 79
- Exophthalmic goitre, treatment by radium, 360  
treatment by X-rays, 317  
object of treatment, 318
- Exostoses, 185
- Exostosis of angle of scapula, *P.* 156
- Exposure, duration of, 42  
table for radiographs, 93
- Eye, diseases of, treatment by radium, 359  
and orbit, localisation of foreign bodies in, 115-118  
Sweet's localiser, 118  
simple methods for localising foreign bodies in, 119
- Eyeball, method of localisation of foreign bodies in, 115
- Eyelid, epithelioma in, treatment by radium, 370
- Face, rodent ulcers treated by radiations, *P.* 309, *P.* 311, *P.* 368
- Femur, development of, 141  
epiphyses of, 145, 148



- Femur, exostoses of, 185  
fractures of, 165  
radiography of shaft of, 135  
sarcoma of, 182, *P.* 183, *P.* 186  
(*see also* Hip-joint and Knee-joint)
- Fibroma uteri, treatment by X-rays—  
indications for, 319  
contra-indications, 319
- Fibromata, treatment by radium, 367
- Fibula, development of, 142  
epiphyses of, 145  
fractures of, 147, 165  
radiography of, 136  
(*see also* Leg and Ankle-joint)
- Filters, additional, 293  
selection of, 293  
use of, 292
- Filtration, Bordier's formula, 321
- Finsen light in treatment of lupus, 304
- Finzi, Dr., method of radiography, 127
- Fissures, treatment by X-rays, 305, 306
- Fluoroscopy for determination of injuries to joints, 154
- Folliculitis barbae, treatment by X-rays, 303
- Foot, bones of—  
congenital deformity of, *P.* 248  
development of, 142  
fractures of, *P.* 169  
radiography of, 136, 145
- Forearm, fracture through lower end of radius, *P.* 162  
fracture of trapezium, *P.* 162  
non-union fracture of ulna and radius, *P.* 162
- Foreign bodies in the alimentary canal, 233  
in the œsophagus, 210  
in the pleural cavity, 204  
in the thorax, 197  
localisation of, 107
- Fracture, morbid conditions of bone which predispose to, 173
- Freiburg School, technique in carcinoma of the uterus, 382  
technique in treatment of uterine fibromata, 319, 322
- French valve tube, 51
- Fulham Cancer Hospital, Electrical Department, 86
- Fuses, main, should always be accessible, 3
- Gaiffe mercury interrupter, 3, 26
- Gaiffe Rochefort outfit, 4  
transformer, 3
- Gallstones, *P.* 214  
reference to Dr. Case's radiographs of, 214
- Gas engine, 11
- Gauss, Dr., technique for treating uterine fibroids by X-rays, 322  
therapeutic tube-stand, 276
- Glands, enlarged, treatment by X-rays, 307  
carcinomatous, treatment by X-rays, 308  
mediastinal, treatment by X-rays, 327
- Glands, enlarged sarcomatous, treatment by X-rays, 308  
inflammatory, treatment by X-rays, 307  
lymphadenomatous, treatment by X-rays, 307  
prostate, cancer in, treatment by radium, 376  
thyroid, treatment by radium, 360  
tuberculous, treatment by radium, 307
- Glossary, 387-390
- Gout, chronic articular, 177  
rheumatic, 178
- Granulation tissue, treatment by radium, 359
- Great Northern Central Hospital, case of fracture of neck of scapula, 159
- Groedal, Dr. Franz, of Mannheim, 207  
examples of cardiac conditions of the heart, 207  
preparation of and results obtained with opaque meal, 215
- Gundelach regulator, 47  
tube, 35, 296  
valve tube, 52
- Guy's Hospital Museum, example of fracture of neck of scapula, 158
- Haenisch, Dr., method of using opaque meal for examination of large intestine, 218  
technique in treatment of uterine fibroids, 319  
uterine fibromata, 319
- Hair, effect of radium upon, 256
- Hampson, Dr., localiser, 113, 114  
treatment of eczematata, 299
- Hand, congenital deformities of, *P.* 248  
development of bones of, 140, 150  
fracture of terminal phalange of thumb, *P.* 164  
fracture through base of metacarpal bone of thumb, *P.* 164  
fractures of bones of, 164  
oblique fracture of shaft of metacarpal bone of little finger, *P.* 164  
normal adult, *P.* 164  
radiograph of normal, 96  
tubercular disease of, *P.* 175
- Haudek, Dr., double opaque meal, 218  
radiographic diagnosis of hour-glass contraction, 223
- Heart, aortic aneurism, 206, 207  
cyst in, 205  
diseases of, 195  
enlarged, *P.* 201  
examination of, 205  
examination of patient in three positions, 206  
examples of cardiac conditions by Groedal, 207  
exposure for, 5  
showing atheroma, *P.* 246  
Stokes-Adams disease, 205  
syphilis, 195  
thoracic aneurism, 205  
tuberculosis of, 195

- Heart, tumours of, 195, 196  
 variation in size, shape, and position of, 205
- Heavy discharges, apparatus for, 4
- Hertz, Dr., description of three positions of stomach, 211-214  
 opinion regarding kink at duodenum, 233  
 preparation of and results obtained with opaque meal, 215
- High-tension current is alternating, 9  
 for rapid radiographs, 10  
 rectifier for valve tubes, 4, 9, 51
- Hip-joint, dislocation of, *P. 166*  
 displacement of upper end of femur in a child, *P. 167*  
 epiphyses of, *117, 148*  
 fracture of femur, *P. 166, (2) P. 169*  
 fragment of shell in, *120*  
 in child, *P. 147*  
 injuries near, 164  
 normal, *P. 166*  
 radiography of, 135  
 tuberculosis of, *175*  
 tuberculous, *P. 173*
- Hodgkin's disease, 196, 199  
 treatment by X-rays, 324
- Holland, Dr. Thurstan, ease of stone in the ureter, 243
- Holzknecht, bismuth examination of the stomach, 219  
 chromo-radiometer, compared with Kienböck method, 285  
 diagrams to illustrate aneurism, etc., 207  
 grouping of radiographic and clinical results of bismuth examination of stomach, 219  
 quantimeter, 281  
 report on aneurism of the aorta, 208
- Hospital, base, installation for (*see* Military hospital)  
 Cancer, electrical department, *86*  
 general, electrical department, *81*  
 organisation of, 85  
 installation for, 82, 83  
 special, installation for, 85
- Hour-glass contraction (*see* Stomach)
- Humerus, development of, 139  
 fractures of, *159, 160, 161*  
 sarcoma of, *P. 183, P. 186*  
 (*see also* Shoulder-joint and Elbow-joint)
- Hydatid cyst, 184, 187, 204
- Hyoid bone, development of, 142
- Hyperidrosis, treatment by X-rays, 305  
 technique in axilla, 305
- Ileum (*see* Intestine, small)
- Ileum and caecum, opaque meal in, *230, 231*
- Induction coils, 7, 12, 13  
 essential parts of, 12
- Inflammation of bone, chronic, 169
- Inflammatory affections of bone, classification of, 168-173  
 glands, treatment by X-rays, 307
- Injuries of bones and joints, 154-166
- Installations (*see* X-ray installations)
- Intensifying screen, use and value of, *96*
- International Congress, 1913, Radiology Section, 222
- Interrupters, causes of defective working, 21  
 di-electric used, 21  
 dipping, *271*  
 electrolytic, 271  
 advantages of, 24  
 description of, 22  
 disadvantages of, 25  
 method of action, 25  
 single-point, 23  
 three-point, 23  
 for alternating current, 26  
 for military hospital, 87  
 Gaiffe mercury, 3, 26  
 improved Maekenzie Davidson, 22  
 Instanta, 20  
 mercury, 270  
 description of, 17  
 Rythmeur, 274  
 Sanax, 20, 81  
 Watson Dreadnought, 18, 19  
 Wehnelt, 6, 22  
 advantages of, 24
- Interruptions, number of, 21
- Intestinal stasis, 233  
 method of examination for, 229
- Intestines, faecal matter in the, 241  
 foreign bodies in the, 241  
 large, Dr. Haenisch's method for examination of, 218  
 Dr. Handek's double-meal method of examination, 218  
 dyschezia, 233  
 examination of, 231  
 tumours of, 233  
 small, duodenal ulcer, 230  
 examination of, 229  
 the duodenum, 229  
 the jejunum and ileum, 230
- Inverse (reverse) current (*see* Current)
- Jaw, dentigerous cyst in lower, *P. 129*  
 fracture of angle of, *155*  
 of lower, *120*  
 through ramus of lower, *P. 129, 155*  
 radiography of, 129
- Jefferson, Dr., radiographs of stomach obtained at Cancer Hospital, 216
- Jejunum (*see* Intestine, small)
- Johnson, Herneman, work on secondary radiations of metals, 254
- Joints, appearance of tuberculosis in, 179  
 diseases of, 174-178  
 loose bodies in, 177  
 normal, radiography of, 123  
 tuberculous disease of, 174
- Joints and bones, injuries of, 154-166
- Joints and epiphyses, radiographic survey of, 144-153
- Jordan, Dr., demonstration of ileal stasis, 233  
 of kinks in colon, 231  
 report on diseases of lungs, 201

- Kidney, calcareous, *P.* 243  
 calculi in, *P.* 241, 241, 245  
 collargol in, *P.* 245  
 cystic conditions of, 246  
 description of, 239  
 disease, in doubtful cases try other methods  
   of examination, 246  
 enlarged movable, 244  
 faecal mass in, *P.* 241  
 relations of, 240  
 tuberculous disease of, 244  
 tumours of, 245  
   malignant, 245-246  
   simple, 245
- Kienböck quantimeter, 282  
 arrangement for exposure, 283  
 development of strips, 283, 284  
 slips, use when treating uterine fibroids, 323  
 standard scale, 285  
 tints of developed strips, 286  
 treatment of ringworm, 300
- King's College Hospital, electrical department, 82, 81  
 filter and screen for radium in use at, 340
- Knee-joint, arthritic changes in, *P.* 176  
 chronic inflammatory conditions of bones,  
*P.* 170  
 epiphyses of, 145, 146, 147, 148  
 fracture of patella, *P.* 168  
   of lower end of femur, *P.* 168  
 in child, *P.* 147  
 injuries to, *P.* 168  
 normal, *P.* 140  
 radiography of, 135  
 rheumatoid changes in, *P.* 176  
 showing chronic inflammatory conditions  
   of epiphyses, *P.* 168  
 tubercular disease of, *P.* 174, *P.* 181  
 tuberculosis of, 176
- Krauss, explanation of action of X-rays in  
 blood diseases, 326
- Lane, Sir Arbutnot, description of kinks in  
 ileum, 231
- Leg, fractures of bones of, *P.* 168-169  
 inflammatory and other affections of bones  
 of, *P.* 171
- Lembeke, technique for treating uterine  
 fibroids by X-rays, 322
- Leonard, Dr. Lester, demonstration of  
 changes in length and breadth of  
 stomach, 221  
 report to radiology section of the Inter-  
 national Congress, 222
- Leucoplakia, treatment by X-rays, 299  
 treatment by radium, 364
- Leucoplakia vulvæ, treatment by radium, 366
- Leukæmia, treatment by X-rays, 253, 324,  
 325
- Lichen, treatment by X-rays, 299
- Localisation of foreign bodies, 107-122  
 in the eye and orbit, 115-118  
 in hip and shoulder, 120, 121  
 in limbs, 121
- Localisation of foreign bodies in the skull,  
 119-128  
 Dawson-Turner formulæ, 113  
 Hampson's method, 113, 111, 121  
 Mackenzie Davidson short method of, 113,  
 113, 119, 121, 122  
   for foreign bodies in eyeball, 115  
 Mackenzie Davidson method in combina-  
 tion with stereoscopy, 119, 121  
 Shenton's method, 115, 121  
 simple methods of, 109, 110  
 stereoscopic method, 118
- Localiser, Mackenzie Davidson, 107  
 cross-thread, 111  
 Sweet, 118, 123, 124  
   for radiographs of the skull, 123  
 Wheatstone, 108
- Lovibond's tintometer, 288
- Lumbar vertebrae, curvature of, *P.* 179  
 ossification of, 143  
 radiography of, 132
- Lungs, abscess of, 203, 204  
 actinomycosis of, 202  
 Bythell's report of examinations of, 201  
 cavities in, 202  
 circulatory disturbances in, 194  
 cirrhosis of, 194  
 congestion of, 194  
 diseases of, 194  
   differential diagnosis, 198-204  
   treatment by X-rays, 327, 328  
 exposure for, 5  
 Hodgkin's disease, 196, 199  
 infarction of the lung, 200  
 Jordan's report of examinations of, 201  
 lympho-sarcomata, 199  
 primary malignant growths of, 199  
 pulmonary apoplexy, 200  
 sarcoma in, *P.* 188, 199  
 tuberculosis of, 195  
 tumours of, 196, 198  
 Wasserman reaction in diseases of lungs,  
 202  
 (*see also* Chest)
- Lupus erythematosus, treatment by X-rays,  
 304  
 treatment by radium, 363
- Lupus vulgaris, treatment by Finsen light,  
 304  
 treatment by radium, 363  
 treatment by X-rays, 304
- Lymphadenoma, treatment by X-rays, 328
- Lymphadenomatous glands, treatment by  
 X-rays, 307
- Lymphatic leukaemia, treatment of, by X-  
 rays, 325
- Macalaster Wiggin tube, 295, 296
- Macé, Professor, unit of measurement for  
 radium, 343, 355, 356
- Mackenzie Davidson localiser, 107  
 cross thread localiser, 111, 112  
 method, 110, 111, 119-122

- Mackenzie Davidson method of localisation for foreign bodies in eyeball, 115  
in combination with stereoscopy, 119, 121  
short method of localisation, 113
- Mackenzie Davidson's experience of radium treatment in diseases of the eye, 359
- Malformations, congenital, 248
- Malignant disease, combined use of radium and X-rays in treatment of, 378  
in treatment endeavour to keep up percentage of red corpuscles in the blood, 254  
treatment by radium is purely local, 263  
treatment of, radium and X-rays are important therapeutic factors, 383
- Malignant invasions of skin, treatment by X-rays, 305
- Malleoli (*see* Ankle-joint)
- Mammæ, carcinoma of, X-ray treatment of, 382
- Manipulation of X-ray tube, 43
- Marie and Ribaut's exposure table, 105
- Mastoid sinuses, position for radiography of, 126
- Maxilla, inferior, fractures of, 156  
superior, fractures of, 156
- Mediastinal cancer, X-ray treatment of, 382  
glands, enlarged, treatment by X-rays, 327
- Mediastinum, diseases of, 196  
treatment by X-rays, 327, 328  
tumours of, 197
- Medullary sarcoma, 187
- Melchencr and Wolff, experiments regarding action of X-rays upon blood, 326
- Meningocele in infant, *P.* 248
- Mercury vapour lamp, 255  
treatment for rodent ulcers, 311
- Mesenteric glands, calcified, *P.* 243  
enlarged and calcified, 241
- Mesothorium and radium, 381
- Metacarpal bones, development of, 140  
fractures of, 164  
radiography of, 134
- Metatarsal bones, development of, 142  
radiography of, 136  
(*see also* Foot)
- Mica regulator, 44, 45
- Military hospital (base), installation for, 87  
collecting hospital, 87  
electrical supply, 87  
petrol engine and dynamo, 87  
portable accumulator batteries, 87  
X-ray installation, 88, 89  
field outfit, 90  
necessary apparatus, 90  
radiography, equipment for, 87
- Miller, Dr. Leslie, mica disc valve, 272
- Milliamperemeter, for measuring X-rays, 57, 69  
D'Arsonval moving-coil dead-beat precision type, 267, 279
- Milligram-hours, unit of radium dosage, 356
- Mollites ossium, 173
- Morton rectifier, 272
- Motor transformers, 12
- Mouth, cancer in, treatment by radium, 373  
examination of, by radiography, 129
- Müller, condition termed myelœmia, 325
- Müller water-cooled tube, 321
- Muscle fibres, effect of radium upon, 257
- Myelœmia, 325
- Myelogenous leukœmia, 325
- Myeloma, 187
- Nævus, treatment by radium, 362  
a good routine, 362
- Nasal bones, fractures of, 156
- Necrosis, 167
- Nerve tissue, effect of radium upon, 256
- Neuritis, 264
- Normal tissues, changes in, due to radiations, *P.* 254
- Nose, diseases of, treatment by radium, 359
- Œsophageal tube, radium tube arranged in, 374, 375
- Œsophagus, bismuth food in, 211  
bismuth food in stricture, *P.* 129  
Brunning apparatus for examination of, 374  
cancer of, treatment by radium, 374  
examination of, 209, 210  
foreign bodies in, 210  
tumours of, 197  
(*see also* Chest)
- Olecranon, fracture of, 161
- Oliver Lodge valve tube, 51
- Opaque meal, 214, 217  
Dr. Haenisch's method for examination of large intestine, 218  
Dr. Haudek's double-meal method, 218  
in colon, 232  
in ileum and cæcum, 230, 231  
precautions to be observed in the conduct of, 218  
radiographic appearances of, 219  
reasons for using barium sulphate, 216  
variations of, for special investigations, 218
- Orbital region, fractures in, 156
- Orthodiagraph, 77
- Orthodiagraphy, 206
- Os calcis, fracture of, 166
- Oscilloscope tube, action of, 53  
for detecting reverse current, 53, 278
- Os innominatum, development of, 140
- Osmosis regulator, 193, 273
- Osteitis, *P.* 170-171  
fibrous, 187  
of cancellous tissue, 168  
of compact bone, 168, 170  
tuberculous, 170  
typhoid, 169, 170
- Osteoarthritis, 178
- Osteomalacia, 173
- Osteomyelitis, 168, *P.* 170-171  
acute, 181  
description of typical X-ray picture, 181

- Osteomyelitis, acute infective, 169  
 septic, 169  
 chronic infective, 180
- Panton and Tidy, results of treatment of  
 blood diseases by X-rays, 326
- Papillomata, treatment by radium, 359  
 superficial, treatment by radium, 363
- Parrot's nodes, 171
- Patella, development of, 141  
 fractures of, 165  
 radiography of, 135  
 (*see also* Knee-joint)
- Pelvis, dermoid cyst in, *P.* 246  
 development of, 148  
 displacement of upper end of femur, *P.*  
 166-167  
 examination of, by radiography, 133, 135  
 fracture of, in child, *P.* 167  
 fractures of, 164  
 in child, *P.* 147  
 normal female, *P.* 133  
 normal male, *P.* 133
- Penetrans tube, 295
- Periosteal proliferation, 180
- Periostitis, 168, *P.* 170, *P.* 170, 180  
 acute infective, 182  
 acute localised, 169  
 tuberculous, 170
- Petrol engine for military hospital, 87
- Phalanges, development of, 140, 142  
 fractures of, 164  
 radiography of, 134, 136
- Phleboliths, 241
- Phthisis, fibroid, 195
- Pirie, Dr. Howard, hand stereoscope, 106, 108  
 technique, 125  
 treatment of hyperidrosis by X-rays, 305
- Pleura, differential diagnosis in diseases of,  
 203  
 diseases of, 195  
 purulent effusion, 204  
 secondary cancerous deposits in, 204  
 tumours of, 196
- Pleural cavity, foreign bodies in, 204  
 effusion, serous, 203  
 effusions in chest, *P.* 190
- Pleurisy, chronic, 203  
 (*see also* Chest)
- Pneumokoniosis, 203
- Pneumonia, broncho-, 194  
 chronic interstitial, 195, 203  
 lobar, 195, 202, *P.* 201  
 (*see also* Chest)
- Portable accumulator batteries, 87
- Pott's fracture, 166
- Primary beams (X-rays), 54, 55
- Prophylactic treatment, should be given in  
 all cases of cancer of the breast, 379  
 in carcinomata, results encouraging, 314
- Prostate gland, cancer in, treatment by  
 radium, 376  
 enlargement of, treatment by X-rays, 316  
 technique, 317
- Protection from shocks, 65  
 of operator, lead-lined screen for, 79  
 of patients in X-ray department, 266  
 of workers in X-ray department, 265, 266
- Prurigo, treatment by X-rays, 299  
 by radium, 364
- Psoriasis, treatment by X-rays, 299  
 by radium, 361
- Ptosis, 222, 223
- Pyloric stenosis (*see* Stomach)
- Pyloroptosis, 223
- Pyo-pneumo thorax, 204
- Qualimeter, Bauer, 56, 57  
 description of, 268  
 use in therapeutics, 57, 278, 279, 281
- Quantimeter, Holzknicht's, 281  
 Ionto, 287  
 Kienböck, 282, 283
- Radiation therapeutics, 249-377  
 treatment by radium, 329-377  
 by radium and X-rays, 378-385  
 by X-rays, 251-328  
 watch carefully the action of both treat-  
 ments, 255
- Radiations lead to constitutional disturbance,  
 (reaction) 262  
 effect upon carcinoma, *P.* 316, *P.* 372  
 normal tissues, *P.* 254, 256  
 rodent ulcer, *P.* 309, *P.* 311, *P.* 368  
 tissues, 251, 252  
 description of plates, 259-261  
 tumours, *P.* 256, *P.* 258, *P.* 260  
 ulcerated carcinoma, *P.* 314
- Radio-active waters, 260
- Radiogene, 357
- Radiographic plates, development, 97, 102,  
 103, 238  
 exposure of, 102, 103  
 fixing, 99  
 intensification, 100  
 printing, 101  
 reduction of, 100  
 washing and drying, 99
- Radiographic prints, 101  
 glazing gelatino-chloride, 104
- Radiographic room at special hospital, 85
- Radiographic survey of joints showing  
 epiphyses, 144-153
- Radiographs, caution regarding distance  
 between subject and X-ray tube, 95  
 exposure times, 95  
 cinematographic, 105  
 distance from subject, 92  
 distant, advantages of, 75, 76  
 exposure, 91  
 exposure table, comparison of different  
 radiometers, 93, 94  
 in reclining position, 74  
 intensifying screen, use and value of, 96  
 intensity of X-rays, 92  
 management of tube for good, 238  
 obtainable of all parts of human body, 69

- Radiographs of the heart, 5, 77  
 of all kinds, 75  
 of the lungs, 5  
 of normal hands, 96  
 of internal organs, 75  
 of the stomach, 5, 75  
 placing of photographic plate, 95  
 plate or film employed, 91  
 production of, 91  
 quality of tube, 92  
 rapid, 6, 10, 93  
   for examination of urinary tract, 236  
   value of, 193  
 single impulse, 8  
   principle of, 8  
   "standard exposures," 76  
 standard points on the median lines, 77  
 stereoscopic, 105  
 straightness of trunk essential, 73  
   apparatus to ensure, 74  
 thickness of the subject, 92  
 use of intensifying screen, 96  
 with single-impulse outfit, 94
- Radiography, cranial, chair for, 127, 128  
 for determination of injuries to joints, 154  
 military, equipment for, 87  
 of the alimentary system, 209  
 of bones and joints, normal, 123  
 of ethmoidal sinuses, 128  
 of frontal air passages, 127  
 of the skull and accessory sinuses, 123, 125  
 of the sella turcica, 127  
 of the sphenoidal sinuses, 128  
 of thorax, 191-194  
 of turbinate bones, 128  
 stereoscopic, 105, 106
- Radiologist, consulting, installation for, 82, 83
- Radiometer, comparison of exposures, 94  
 Walter's, 58, 59, 61  
 Walter-Benoist, 59, 61  
 Welmelt's crypto-, 59, 61
- Radioscopy of the alimentary system, 209  
 of the opaque meal, precautions necessary, 218  
 of thorax, 188  
   routine examination, 189  
   technique of examination, 188-191  
 the recumbent position, 188
- Radium, an important therapeutic agent, 383  
 and its activity, relation between the value of, 354  
 applicator attached to a uterine sound, 365, 366  
 applicator for floor of mouth, 373  
 applicators, various forms of, 340, 348, 350, 351  
 Beta and Gamma rays in therapeutics, 356  
 cautions regarding use of large quantities, 353  
 effect upon cancer, *P.* 372  
   rodent ulcer, *P.* 309, *P.* 311, *P.* 368  
 filtration of rays, 350
- Radium, influence of air-space, 352  
 flat applicators for, 361  
 Gamma ray alone, 356  
 method of using, 345  
   as an inhalation, 346, 347  
   in glass or metal applicators, 347, 348, 350, 351  
   in water, 346  
   upon metal points, 347  
 practical application of, to disease, 345-377  
 salts of, 348  
   age of, 354  
   in tubes, 349  
   upon linen to form *toiles* (French method), 349  
   variation of activity, 355  
   secondary radiations from tubes, 351
- Radium, physics of, 329-344  
 apparatus for charging glass applicators, 334  
 for obtaining radium emanation, 333  
 for preparation of water impregnated with radium, 338  
 curve showing decay of radium emanation, 335  
 electroscope, special gold leaf, 332  
 friction device for charging electroscopes, 342  
 ionisation and recombination, 331  
 measurement, 341  
 physiological action, 343  
 radium emanation, 333  
 units of measurement, 342  
 values for the weight of radium element in salts, 339  
 various forms of applicators, 340
- Radium therapy, 329-377  
 action of radiations on blood-vessels, 257  
   on hair, 256  
   on muscle fibres, 257  
   on nerve tissues, 256  
   upon normal tissues, 256, 261  
   upon the skin, 256  
   on sweat glands, 257  
   on vascular connective tissue, 257  
 application to the interior of oesophagus, 350, 351  
   into the substance of tumours, 350, 352  
 applicators, various forms of, 340, 348, 350, 351  
 Becquerel ray, special action of, 258  
 changes induced in tumour cells by, 382  
 dangers attendant on the use of, 263  
   late manifestations, 264  
 dosage in, 353  
   of emanation in solution, 355  
   unit in milligram-hours, 356  
   when the free radium is contained in metal tubes, 356  
   when using flat applicators, 355  
   when using the Gamma ray alone, 356  
 early work of Dominici with Gamma ray, 251

- Radium therapy, early work of Wickham, 251  
 effect of Beta rays, 251, 258  
   of radiations upon blood-pressure, 358  
   upon tumour cells, 258  
 exercises an action upon all living cells, 259  
 external and internal application, 350  
 factors influencing the result of treatment, 260  
 filtration of rays, 350  
 Gamma ray, action upon cancer, 265  
 hard Beta rays and Gamma rays, effect upon cancer, 254, 259  
 heavy doses, important points regarding, 381  
 in diseases of the ear, 359  
   of the eye, 359  
   of the nose, 359  
   of the throat, 359  
 in general diseases, 357  
 in gynæcological practice, 365  
 in inflammatory conditions, 257  
 in tumours, 257  
 less virulent cases most amenable to treatment, 384  
 method of treatment, 346  
 other methods of treatment not to be neglected during radiation treatment, 384  
 penetrating power of the ray only one factor, 381  
 radiations lead to constitutional disturbance (reaction), 262  
 the skin must be protected in treatment of deep-seated diseases, 258  
 treatment of cancer of the bladder, 377  
   cancer of the œsophagus, 374  
   cancer of the prostate gland, 376  
   cancer of the rectum, 375  
   cancer of the tongue and mouth, 373  
   carcinomata, 371, 372  
   deep-seated tumours by external applications, 352  
     cautions to be observed, 353  
   diseases of the skin, 361  
     exposure, 361  
     large areas, 361  
   exophthalmic goitre, 360  
   infiltrating epithelioma, 370  
   malignant disease of the thyroid gland, 360  
   patients in hospital or at their homes, 358  
   sarcomata, 371, 372  
   superficial epithelioma and rodent ulcer, 368  
   tube inserted in œsophageal tube, 374, 375  
     into bowel, 376  
   warning against too hasty assurance of cure by, 259
- Radium and mesothorium, 381  
 and oxygen, for inhalation, 346, 347  
 and X-rays, combined use in treatment of malignant disease, 378-385  
 in carcinoma of the uterus, 382
- Radium and X-rays, no case should be refused a trial, 379  
 effect upon rodent ulcer, *P. 368*  
 X-rays and CO<sub>2</sub>, effect upon rodent ulcer, *P. 309, P. 311*
- Radius, development of, 140  
 fracture of, 159, 161, 162  
   investigations of cases, 162  
 radiography of, 134  
 (*see also* Elbow-joint, Forearm, and Wrist)
- Rectifier, high tension, 4, 5, 9  
 for valve tubes, 51
- Rectum, cancer in, treatment by radium, 375  
 description of, 232
- Regeneration of vacuum of X-ray tubes, methods used for, 44
- Regulation of valve tubes, 51
- Regulation of X-ray tubes, 40, 42  
 deciding when necessary, 43
- Regulator, Bauer air-valve, 46  
 double, 45  
 Gundelach, 47  
 mica, 44, 45
- Resistance, for control of interrupter, 274
- Reverse (inverse) current (*see* Current)
- Rheostat, series, 16
- Rheumatic gout, 178
- Rheumatism, chronic articular, 177
- Rheumatoid arthritis, 178  
 changes in joints, *P. 176*
- Ribs, fracture of, 157
- Rickets, 172
- Rieder, Dr., cinematographic demonstrations  
 of contractions of stomach, 219, 221  
 exposure stand, 79  
 preparation of and results obtained with opaque meal, 215, 221
- Ringworm, treated by X-rays, 299-301, 302
- Röntgen rays (*see* X-rays)
- Rose and Carless, example of fracture of neck of scapula, 158
- Rosenthal, cinematographic demonstrations  
 of contractions of stomach, 219, 221
- Sabouraud and Noire pastilles for dosage, 279-292  
 Bordier's chromo-radiometer, 282  
 Hampson's radiometer, 290, 291  
 Holzknecht's quantimeter, 281  
 light for examining, 280  
 Lovibond's tintometer, 288  
 method compared with Kienböck, 285
- Sadler, work on secondary radiations of metals, 254
- Salmond, Dr. R. W. A., investigations by, 162  
 investigation regarding X-ray filters, 293
- Salvarsan, injection of, 255
- "Sanax" interrupter, 81
- Sarcoma, in mediastinum and lungs, *P. 188*  
 of bone, 183  
 of clavicle, 184  
 of femur, 182, *P. 183, P. 186*  
 of humerus, *P. 183, P. 186*  
 of the lung, 199

- Sarcoma, medullary, 187  
 myeloid, 184  
 recurrent, treatment with radium, 371
- Sarcoma, chondro-, of lower end of tibia, 183
- Sarcomata of bone, 187  
 of lungs, treatment by X-rays, 328  
 treatment by radium, 371, 372  
 treatment by X-rays, 312
- Sarcomatous glands, treatment by X-rays, 308
- Scale, comparative, of the usual instruments for measuring the hardness of X-ray tubes, 61, 268  
 showing filter equivalents, 293
- Scalp, septic condition, treatment by X-rays, 301  
 tuberculous condition, treatment by X-rays, 301
- Scapula, development of, 138  
 fracture of, 157, 158  
 acromion process, 158  
 body, 158  
 coracoid process, 158  
 neck of, 158  
 Astley Cooper, South, and Rose and Carless on, 158  
 case at Great Northern Central Hospital, 159  
 example in Guy's Hospital Museum, 158  
 first authentic case of (Spence), 159  
 spine, 158  
 (*see also* Shoulder-joint)
- Schönburg, Dr. Albers, compressor, 237  
 technique in treatment of uterine fibromata, 319  
 uterine myomata and climacteric troubles, 320
- Schwartz capsule, use of, 222  
 technique for use of bismuth in stomach, 225
- Sclerosis of bone, 168
- Screen examination of urinary tract, 236
- Screen, lead lined, for protection of operator, 79
- Screening stands, 70-73  
 Levy Dorn, 70, 71  
 upright, 70, 71  
 with stereoscopic movements, 189  
 Wenckebach, 72, 73
- Secondary radiations of metals, 254  
 iron stands high in the list, 254
- Secondary rays, 51, 55
- Sector, use of, 78
- Selection of X-ray tubes, 40
- Series rheostat, 16
- Serous pleural effusion, 203
- Sesamoid bones, development of, 153
- Shell, portion of, in hip-joint, 120  
 in limb, 121  
 in tibia, 121  
 shrapnel, in hand, 121
- Shenton's method of localisation, 115
- Shoulder-joint, epiphyses of, 151, 152  
 exostosis of angle of scapula, *P.* 156  
 fracture at upper end of shaft of humerus, *P.* 156, *P.* 158  
 fracture of clavicle, *P.* 158  
 fracture through great tuberosity, *P.* 156  
 fracture through lower aspect of glenoid cavity, *P.* 158  
 normal, *P.* 155, 152  
 radiography of, 133, 134  
 separation of the great tuberosity of humerus, *P.* 158  
 tubercular disease of, *P.* 175
- Single impulse current, of great intensity, 6  
 outfit, 7  
 special automatic switch for, 16  
 radiographs, apparatus for, 5  
 system, 7  
 taking radiographs by, 8
- Skin, effect of radium upon, 256  
 malignant invasions of, treatment by X-rays, 305
- Skin diseases, treatment by radium, 361  
 of large areas, 361  
 use of Gamma ray, 361  
 treatment by X-rays, 298
- Skull, development of bones of, 143  
 fracture of the vault of, 155  
 from a case of tumour of the brain, *P.* 128  
 injuries of, 154-156  
 localisation of foreign bodies in, 119-128 (normal), *P.* 124, *P.* 126  
 of a child, *P.* 126, *P.* 128  
 showing erosion of occipital bone, *P.* 128  
 showing good detail in soft parts, *P.* 129
- Skull and accessory sinuses, radiography of, 123  
 Dr. Martin Berry's chair for, 123, 125
- Slide rule, 92, 93
- Snook apparatus, 9, 10, 126, 272
- South, and fracture of neck of scapula, 158
- Spark gap, 48  
 length, 14
- Spence, first authentic case of fracture of neck of scapula, 159
- Sphenoidal sinuses, radiography of, 128
- Spine, caries of cervical vertebræ, *P.* 179  
 sacrum and lumbar vertebræ, *P.* 179  
 curvature of lower dorsal and lumbar vertebræ, *P.* 179  
 upper dorsal, *P.* 179  
 dorsal, radiography of, 132  
 injuries of, 154, 156, 157  
 lumbar, radiography of, 132  
 normal lumbar, *P.* 133  
 tumours of, 197
- Spintermeter, 56
- Spleno-medullary leukæmia, treatment by X-rays, 325
- Stereoscope, Pirie, 106
- Stereoscopic fluoroscopy, 106  
 method of localisation, 118  
 in combination with Mackenzie Davidson method, 119



- Stereoscopic negatives, examination of, 108,  
110, 111  
plates should be developed together, 107  
radiography, 105
- Sternum, development of, 142  
radiography of, 131
- Stokes-Adams disease of heart, 205
- Stomach, anatomy of, 211  
atony of, 225  
callous ulcers, 224  
cancer of, 227, 228  
cinematographic demonstrations of con-  
tractions of, 219  
diagrams showing stages of filling, 213  
disturbance of secretion, 222  
effect of pressure of disease in other organs,  
228  
empty, 212  
examination of, 210  
exposure for, 5  
full, 214  
functional disturbances of, 220  
half-filled, 212  
Hertz description of three positions of,  
211-214  
Holzknecht's grouping of radiographic and  
clinical results of bismuth examination  
of, 219  
hour-glass contraction of, 223, (inter-  
mittent) 225, (true) 226, (non-malign-  
ant) 226, (malignant) 227  
"magenblase" in, 214, 221, 226  
motility of, 221  
opaque meal in, 214, 217  
variations of, and results obtained, 215  
pathological changes in form and position  
of, 222  
conditions of, 222  
penetrating ulcer in, 225  
position of, 212  
pseudo contractions of, 225  
ptosis, 222  
pyloroptosis, 223  
radiographic appearances of, 219  
radioscopy of, precautions necessary, 219  
Schwartz technique for use of bismuth in,  
225  
showing hour-glass contraction, *P.* 226  
obstruction at pylorus, *P.* 222, *P.* 230  
pyloric stenosis, *P.* 213, *P.* 226  
time taken to empty, 221  
tumour of, 228  
types of, 220  
ulcer of, 223  
variations in position and size of, 220  
stomach and colon showing visceroptosis,  
*P.* 218, *P.* 220  
opaque meal in, *P.* 222
- Stone (*see* Calculi)
- Swallowing, act of, radiographed, 6
- Sweat glands, effect of radium upon, 257
- Sweet's localiser, 123, 121  
for the eye and orbit, 118  
for radiography of the skull, 123
- Switchboard, 267
- Syphilis, 195, 202  
congenital, 171  
of bone, 180
- Syphilitic dactylitis, 180  
diseases of bone, 171  
lesions of skin, chronic, treatment by X-  
rays, 305
- Szillard, the Ionto quantimeter, 287
- Table of development of tarsus, 144  
of carpal bones, 149  
of exposures for radiographs, 93  
with radiometers, 94  
Marie and Ribaut's, 105
- Tachymeter, 271
- Tarsal bones, radiography of, 136
- Tarsus, table of development of the, 144
- Teeth, examination of, by radiography, 129
- Tele-Röntgenography, 76, 208
- Therapeutic coil, 269  
doses of X-rays, dipping interrupter for  
regulation of, 271  
outfit suitable for deep therapy, 269  
tube, choice of, 294  
tube-stand, 275  
by Gaiiffe, 275  
by Dr. Gauss of Freiburg, 276
- Therapeutics, use of qualimeter, 57
- Thoracic aneurism, 205  
area, treatment by X-rays, 327
- Thorax and its contents, X-ray examination  
of, 188-208  
bismuth food in, 211  
diseases of, 194-197  
foreign bodies in, 197  
lateral view of, 211  
malignant diseases of, 196  
of adult, practically normal, 190  
pyo-pneumo, 204  
radiography of, 191-194  
radioscopy of, 188  
routine examination, 189  
technique of examination, 188-191  
results obtained at Cancer Hospital in  
examination of, 194
- Throat, diseases of, treatment by radium, 359
- Tibia, development of, 141  
epiphyses of, 145  
fractures of, 147, 165  
radiography of, 136  
(*see also* Leg)
- Tidy and Panton, results of treatment of  
blood diseases by X-rays, 326
- Tissues, effect of radiations upon, 251, 252  
description of Plates showing, 259-261  
normal, changes in, due to radiations,  
*P.* 251  
normal, radiations upon, 256
- Tongue, cancer in, treatment by radium, 373
- Tonsil, carcinoma of, treatment by radium,  
370
- Transformer, 6  
Gaiiffe-Rochefort, 3

- Transformer, high-tension, 9  
 motor, 12
- Traumatic myositis ossificans, 186
- Trichophytia, treated by X-rays, 299-301, 302
- Trochanter, great, fracture of, 165
- Tube (*see* Valve tubes and X-ray tubes)
- Tube-box, 63  
 description of, 64  
 protected, underneath couch, 68
- Tube-stands, 62-78  
 accessories, 65  
 carrier, 65  
 centering device, 66  
 compressor diaphragm, 65  
 holders, 66  
 iris diaphragm, 61, 66  
 lead-glass tubes, 66  
 rectangular diaphragm, 65  
 shutter diaphragm, 66  
 instructions for use of, 66  
 pillar, 62, 63, 64, 65  
 description and use of, 62-66  
 protected, 62, 63, 65  
 universal safety and protective, 73, 74  
 sector provided for, 77
- Tubercular dactylitis, 180
- Tuberculosis in joints, appearance of, 179  
 of the heart, 195  
 of the lungs, 195, 200  
 sub-acute or chronic, treatment by X-rays, 328
- Tuberculous disease of bone, 170  
 diseases of bones and joints, *P. 173, P. 174, P. 175, P. 181*  
 disease of the kidney, 244  
 epiphysitis, 170  
 glands, treatment by X-rays, 307
- Tuberculous osteitis, 170  
 periostitis, 170
- Tumour cells, action of radiations upon, 258  
 changes induced by radiations, 382
- Tumours, changes in, due to radiations,  
*P. 256, P. 258, P. 260*  
 of bone, 182, *P. 183, P. 186*  
 differential diagnosis of, 185-187  
 of chest walls, 197, 204  
 of clavicle, 184  
 of the heart, 195, 196  
 of the kidney, 245  
 of large intestine, 233  
 of the lungs, 196, 198  
 of the mediastinum, 197  
 of the cesophagus, 197  
 of the pleura, 196  
 of the spine, 197  
 of the stomach, 228  
 sections of, before treatment by radiations,  
*P. 260*
- Tungsten metal, most suitable for anti-cathode of X-ray tubes, 8
- Turbinate bones, radiography of, 128
- Turner, Dawson, expression of radium dosage in milligram-hours, 356  
 formula for localisation, 113
- Turner, Dawson, record of treatment of exophthalmic goitre by radium, 360
- Typhoid osteitis, 169, 170
- Ulcer, chronic, treatment by X-rays, 305  
 of stomach, 223  
 rodent, treatment by radium, 359, *P. 368*  
 radium and X-rays, *P. 368*  
 radium, X-rays, and CO<sub>2</sub>, *P. 311*  
 X-rays, 309-311  
 superficial, 310  
 simple, treatment by X-rays, 305  
 situated near the orbit, treatment by radium, 369
- Ulcerated carcinoma, treatment by X-rays, *P. 314*
- Ulna, development of, 139  
 fracture of, 159, 161, 162  
 investigation of cases of, 163  
 radiography of, 134  
 (*see also* Forearm)
- Universal examining chair, 78, 79  
 tube-stand, 73-74
- Ureters, 240  
 calculi in, 242, 243  
 calculus in, *P. 245*  
 collapse of, *P. 245*  
 demonstration of with collargol solution, 247  
 occlusion of, 246
- Urinary calculi, *P. 241, P. 244, 241-244*  
 organs, anatomical relations of, 239  
 diagram of areas to be radiographed, 239  
 system, technique of examination with collargol solution, 247  
 dangers arising from the use of collargol, 247  
 demonstration of the ureter, 247  
 position of the patient, 247  
 strength of solution employed, 247
- tract, diseases of, 240  
 X-ray examination of, 235  
 examination of the patient, 236  
 screen and radiographic, 236  
 technique, 235  
 preparation of the patient, 235
- Uterine fibroids, Bordier technique with X-rays, 321  
 Haenisch technique with X-rays, 320  
 incident dose of X-rays for, 322  
 use of Kienböck slips when treating by X-rays, 323
- Uterine fibromata, techniques of Albers Schönberg, Haenisch, Bordier, and members of Freiburg School, 319  
 treatment by X-rays, 318
- Uterine fibromyomata, treatment by X-rays, 315
- Uterine myomata, Albers Schönberg technique with X-rays, 320
- Uterine sound, a, for application of radium, 365, 366
- Uterus, carcinoma of the, combined use of radium and X-rays, 382

- Valve tubes, 48, 50, 267, 269  
 American, 52  
 French, 51  
 Gundelach, 52  
 high-tension rectifier for, 51  
 in series, 50  
 Oliver Lodge, 51  
 regulation of, 51  
 should never be worked "hard," 52  
 triple, 273  
 use of, 274
- Vascular connective tissue, effect of radium upon, 257
- Verrucae vulgari, treatment by X-rays, 304
- Vertebrae (*see* Spine, Cervical, Dorsal, and Lumbar)
- Vertebral column, development of bones of, 143
- Visceroptosis (*see* Stomach)
- Walsham, description of case of fracture of neck of scapula, 158
- Walter's radiometer, 58, 59, 61
- Walter-Benoist radiometer, 59, 61
- Warts, treatment by radium, 363  
 treatment by X-rays, 304
- Wassermann reaction, 202
- Water-cooled tubes (*see* X-ray tubes)
- Waters, radio-active, 260
- Wehnelt's crypto-radiometer, 59, 60, 61  
 interrupter, 6
- Wernekros, Professor, results of experiments with radiations, 380
- Wheatstone localiser, 108  
 stereoscope, 106
- Wickham, early work in radium therapy, 251  
 on changes which occur in radium therapy, 257, 258
- Wolf and Melchener, experiments regarding action of X-rays upon blood, 326
- Wrist, Colles fracture, *P. 163*  
 chronic osteitis after injury to, *P. 171*  
 displaced epiphyses of lower end of radius, *P. 164*  
 fracture of trapezium, *P. 162*  
 of lower end of radius, *P. 163*  
 separated epiphysis of lower end of radius, *P. 163*
- Wrist-joint, epiphyses of, 148, 149  
 injuries at, 162  
 radiography of, 134
- X-rays, action of radiations upon tissues, 252  
 an important therapeutic agent, 383  
 apparatus arranged on upright cabinet, 277  
 caution regarding, 95  
 comparison of units of measurement for dosage, 321  
 couch with compressor, 237  
 cubicle, 266  
 dangers attendant on the use of, 263  
 late manifestations, 264  
 intensive treatment, 264
- X-rays, degree of penetration, instrument for measuring, 59, 60  
 diaphragms for suppression of secondary rays, 54, 55  
 dipping interrupter for regulation of therapeutic doses, 271  
 effect upon recurrent carcinoma after operation, *P. 372*  
 ulcerated carcinoma, *P. 314*  
 employment in therapeutics, hardest rays give best results, 252, 254  
 erythema dose in therapeutics, 57, 58  
 examination of thorax and its contents, 188-208  
 of urinary tract, 235  
 examination of the patient, 236  
 preparation of the patient, 235  
 rapid radiographic exposure, 236  
 screen examination, 236  
 technique of, 235  
 importance of, in relation to diagnosis of cancer, 227  
 installation; it is advisable to wire for larger capacity than is required, 3  
 installation, for a general hospital, 82  
 for a consulting radiologist, 82  
 for a special hospital, 85  
 for a base hospital (military), 87  
 portable, for a collecting hospital (military), 88, 89  
 field outfit, 90  
 small, 80, 81  
 intensity of, 92  
 varies with distance between anti-cathode and plate or object, 94  
 measurement of by milliamperemeter, 60  
 method of connecting valve to tube, 275  
 observations on blood changes induced by, 253  
 production of, 39  
 protected tube-box, 278  
 radiations always lead to constitutional disturbance, 262  
 secondary, 69  
 secondary radiation, cause of, 54  
 diagram illustrating, 54  
 methods of suppression, 54, 55  
 technique for exposures with qualimeter, 58  
 testing the apparatus, 278
- X-ray therapeutics, 251-328  
 advance in technique, 378  
 arrangement of apparatus, 267-278, 276, 277  
 changes induced in tumour cells, 382  
 choice of tube, 294  
 control apparatus, 266  
 early work, 265  
 filter equivalents, 293  
 filters, additional, 293  
 selection of, 293  
 use of, 292  
 heavy doses, important points regarding, 381

- X-ray therapeutics, less virulent cases are more amenable to treatment, 384  
 methods of protection for workers, 265  
 methods used in estimation of dosage—  
   indirect, 278  
   direct, 279  
 other methods of treatment not to be neglected during radiation treatment, 384  
 penetrating power of the ray only one factor, 381  
 record of exposures, 287  
 Sabouraud and other pastilles, 279-292  
   light for examining, 280  
 special points for instrumentation, 265  
 testing the apparatus, 278  
 treatment couch, 276  
   stand, 276  
 treatment of cancer, 292  
   of carcinoma of the mammae, 382  
   of carcinomata, 312  
     before operation, 313  
     inoperable, 315  
     post-operative, 313  
     recurrent, 316  
     results of prophylactic, 314  
   of diseases of the blood, 323-327  
     action of X-rays, 326  
     blood change desired, 327  
   of diseases of the lungs and mediastinum, 327, 328  
     technique, 328  
   of enlarged lymphatic glands, 307-309  
   of enlargement of prostate gland, 316  
     technique, 317  
   of epitheliomata, 312  
   of exophthalmic goitre, 317  
     object of treatment, 318  
   of leukaemia, 252  
   of malignant disease of the pelvic organs, 379  
   of mediastinal cancer, 382  
   of non-malignant neoplasms, 378  
   of ringworm, dosage for, 280  
   of rodent ulcers, 309-311  
     after ulcer has healed, 311  
     distinction from epithelioma, 311  
     if ulcer increases, 311  
   of sarcomata, 312  
   of simple ulcers, 305  
   of skin diseases, 298-305  
     chronic conditions benefit most by, 298  
     technique and data, 298  
     of uterine fibromata, 318
- X-ray tubes, air-cooled, 31  
 American, 35-39, 126  
 Coolidge, 35-38, 94, 95, 269, 291  
   battery for, 37  
 Cyclops radiator, 30  
 Dessaur, 31, 296
- X-ray tubes, Gundelach, 35  
 Gundelach valve, 52  
 Macalaster Wiggin, 295  
 Müller, 238  
 Penetrans, 295, 296  
 water-cooled, 296, 321  
   advantages of, 32  
   Müller, 31, 32  
   principal feature of, 32  
   selection of, 32  
   use of, 33
- X-ray tubes and accessories, 28  
 anti-cathode, the, 29, 39  
 appearance of, in action, *frontispiece*, 40  
 arrangement for water cooling, 294  
 blackening of, 49  
 box, efficiently protected, 278  
 choice of, for therapeutic work, 294  
 connections, 15  
 connections to the coil, 40  
 description of manufacture, 29  
 diagram of, 28  
 distance from subject, 92  
 focus tube, the, 28  
 for heavy currents, 296, 297  
 for superficial work, 295  
 hardness of, instruments for estimating, 55, 58, 59  
   comparative scale, 61, 268  
 management of, for good radiographs, 238  
 manipulation of, 43  
 method of operating, 38  
 methods used for cooling, 297  
   regeneration of vacuum, 44  
 overheating, 49  
 quality of, for radiographs, 92  
 radiator tube for heavy discharges, 29  
 regulation of, 40, 42  
   deciding when necessary, 43  
 regulator, Bauer air-valve, 46  
 Gundelach, 47  
   mica, 44, 45  
 selection of, 40  
 several should be in use, 41, 238  
 stand for deep therapeutic work, 275  
 too hard for regulation, 42  
 work by Barkla, Sadler, and Hernemann  
   Johnson on secondary radiations of metals, 254
- X-rays and radium, combined use in treatment of malignant disease, 378-385  
 effect upon rodent ulcer, *P.* 368  
 in carcinoma of the uterus, 382  
 malignant disease, 378-385  
 no case should be refused a trial, 379
- X-rays, radium, and CO<sub>2</sub>, effect upon rodent ulcer, *P.* 309, *P.* 311
- Ziegler, explanation of action of X-rays in blood diseases, 326  
 Zygomatich arch, fractures of, 156

new to ...  
of ...  
of ...

University of California

SOUTHERN REGIONAL LIBRARY FACILITY

305 De Neve Drive - Parking Lot 17 • Box 951388

LOS ANGELES, CALIFORNIA 90095-1388

Return this material to the library from which it was borrowed.



D 000 207 258 5

WN100  
K74r  
1916

Knox.

Radiography, x-ray therapeutics  
and radium therapy

WN100  
K74r  
1916

Knox.

Radiography, x-ray therapeutics and  
radium therapy

CALIFORNIA COLLEGE OF MEDICINE LIBRARY  
UNIVERSITY OF CALIFORNIA, IRVINE  
IRVINE, CALIFORNIA 92664

